



Smart solutions in filtration

CABIN FILTERS
Catalogue 2016/17



**PROTEZIONE E SICUREZZA
PER GUIDATORE E PASSEGGERI**
**PROTECTION AND SAFETY FOR
DRIVER AND PASSENGERS**



CABIN FILTERS
Catalogue 2016/17

Ultra-thin III
Filtration Technology

www.tecneco.com



Cert. nr 50 100 9952

FILTRI ABITACOLO / CABIN FILTERS

MEDIA FILTRANTE IN FIBRA SINTETICA

Media filtrante in fibra sintetica ad alta efficienza di filtrazione con struttura progressiva delle fibre.

Ciò significa che seguendo il senso di avanzamento dell'aria queste diminuiscono di dimensione e aumentano di densità e concentrazione. E' così garantita una reale azione di filtrazione in profondità ed un elevato immagazzinamento polveri, garantendo contemporaneamente una buona permeabilità dell'aria.

SYNTHETIC FIBER FILTRATION MEDIA

Synthetic fiber media filtration with high efficiency filtration and progressive structure of the fibers. This means that following the advance direction of the air the fibers diminished in size and increase in density and concentration. It 's ensures a real action of depth filtration and a high dust storage, while ensuring a good air permeability.

MEDIA FILTRANTE MULTISTRATO FIBRA /CARBONI

I filtri abitacolo combinati con carboni attivi TECNECO hanno le stesse caratteristiche e funzionalità dei filtri particellari ma in più sono dotati di uno strato di carboni attivi in grado di assorbire e ridurre cattivi odori e gas pericolosi per la salute del conducente e dei passeggeri.

FIBER/CARBON MULTILAYER FILTRATION MEDIA

TECNECO cabin air filters combined with active carbon have the same features and functionality of the particulate filters but most are equipped with a layer of activated carbon that absorb odors and dangerous gases for the health of the driver and passengers.



CORPORATE

SOLUZIONI INTELLIGENTI NELLA FILTRAZIONE

TECNECO progetta, produce e commercializza filtri aria, filtri olio, filtri carburante e filtri abitacolo per automobili, veicoli commerciali leggeri, mezzi agricoli e industriali.

Il nostro core business è l'Aftermarket Indipendente (IAM), settore che attrae il 70% del volume di affari annuo con una percentuale del 55% in Italia e del 45% all'esportazione. Il 30% della produzione è destinato al settore Industrial che comprende la produzione conto terzi per altri players nel campo della filtrazione automotiva e la produzione per il settore del Ricambio Originale (OES) e del Primo Impianto (OEM).

Il nostro impegno è offrire prodotti di qualità, essere competitivi ed affidabili, operare in sinergia con i nostri clienti che consideriamo prima di tutto nostri partners.

CORPORATE

SMART SOLUTIONS IN FILTRATION

TECNECO designs, manufactures and markets air filters, oil filters, fuel filters and cabin air filters for passenger cars, light commercial vehicles, agricultural and industrial vehicles.

Our core business is the Independent Aftermarket (IAM), a sector that attracts 70% of the annual turnover at a rate of 55% in Italy and 45% for exportation. The 30% of the production is directed to the industrial sector which includes contract manufacturing for other players in the field of filtration and the production for the Original Equipment Spareparts sector (OES) and Original Equipment Mounted sector (OEM).

Our commitment is to offer quality products, to be competitive and reliable, to work in synergy with our clients that we consider first of all our partners.

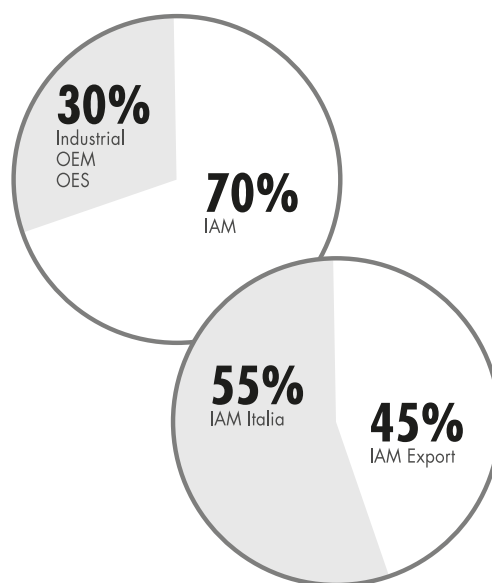
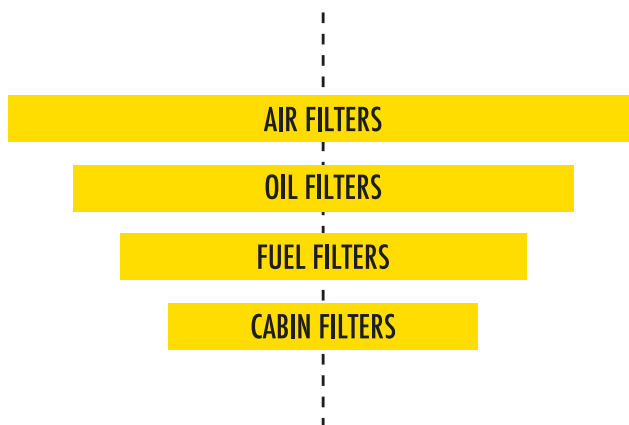

PRODOTTI

FILTRI ARIA, FILTRI OLIO, FILTRI CARBURANTE PER MOTORI A COMBUSTIONE E FILTRI ARIA ABITACOLO

La gamma prodotti TECNECO comprende filtri aria radiali, pannello e industriali, filtri olio spin-on, ecologici e immersione, filtri carburante in metallo, in linea, immersione e ecologici, filtri abitacolo in fibra e combinati con carboni attivi.

Tutti i nostri prodotti sono realizzati con l'impiego di materiali conformi e specifici e con l'utilizzo di impianti di produzione veloci, versatili ed affidabili.



FILTRI ARIA

- Radiali
- Pannello
- Industriali

AIR FILTERS

- Radial
- Panel
- Industrial

PRODUCTS

AIR FILTERS, OIL FILTERS, FUEL FILTERS FOR INTERNAL COMBUSTION ENGINES AND CABIN AIR FILTERS

TECNECO product range includes radial, panel and industrial air filters, spin-on and ecological oil filters, metal, in-line and ecological fuel filters, fiber and activated carbon combi cabin air filters.

All our products are manufactured with compliant and specific materials and using fast, versatile and reliable production machinaries.



FILTRI OLIO

- Spin-on
- Ecologici
- Immersione

OIL FILTERS

- Spin-on
- Ecological
- Refil



FILTRI CARB.TE

- In Metallo
- In Linea
- Immersione
- Ecologici

FUEL FILTERS

- Metal
- In-line
- Ecological
- Refil



FILTRI CABINA

- In Fibra
- Carboni Attivi

CABIN FILTERS

- Fiber
- Carbon

Ultra-thin III
Filtration Technology



TECNOLOGIE

TECNOLOGIE PRODUTTIVE AVANZATE ED AFFIDABILI ALLA BASE DI PRODOTTI DI QUALITÀ CHE CONIUGANO FUNZIONALITÀ E COSTI

TECNECO dispone di tecnologie produttive avanzate ed affidabili che ci permettono di realizzare prodotti di qualità e contenere tempi e costi di produzione per essere competitivi in un mercato sempre più esigente.

Il 90% delle lavorazioni necessarie per produrre un filtro aria, olio o carburante, sono eseguite all'interno dei nostri stabilimenti, iniziando con la produzione degli elementi filtranti e lo stampaggio di componenti metallici e poliuretanici, passando per le fasi di assemblaggio fino ad arrivare al controllo finale di ogni prodotto finito.

Parte fondamentale del nostro processo produttivo è il controllo costante di ogni particolare. Siamo attrezzati con sistemi di collaudo in linea che verificano il 100% dei filtri prodotti e abbiamo al nostro interno un laboratorio dove vengono eseguiti controlli sui materiali in entrata e test funzionali sui prodotti finiti.

TECHNOLOGY

ADVANCED AND RELIABLE PRODUCTION TECHNOLOGIES AT THE BASE OF QUALITY PRODUCTS THAT COMBINE FUNCTIONALITY AND COST

TECNECO has advanced and reliable production technologies that allow us to produce quality products and reduce time and cost of production in order to be competitive in an increasingly demanding market.

The 90% of the necessary operations to produce an air, oil or fuel filter are performed within our plant, starting with the production of filter elements and the molding of metal components and polyurethane, passing through the stages of assembly and ending with the final check of each finished product.

A fundamental part of our manufacturing process is the constant control of every detail. We are equipped with in-line testing systems that verify 100% of the filters produced and we have a laboratory where checks are performed on incoming materials and functional tests on finished products.

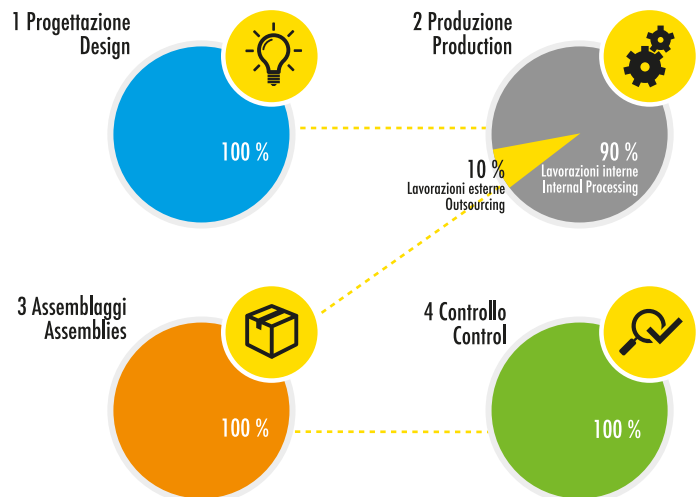

STABILIMENTI

DUE STABILIMENTI PRODUTTIVI IN ITALIA STRUTTURATI SECONDO UNA MODERNA ORGANIZZAZIONE DEL LAVORO

TECNECO opera in due stabilimenti produttivi situati a Collepasso in provincia di Lecce.

I due stabilimenti sono strutturati secondo una moderna ed efficiente organizzazione del lavoro, dotati di impianti di produzione versatili ed affidabili e gestiti secondo un sistema di gestione della qualità certificato sulla base della norma ISO 9001:08 dall'ente TÜV.

PLANTS

TWO PRODUCTION PLANTS IN ITALY STRUCTURED WITH A MODERN ORGANIZATION OF THE WORK

TECNECO operates in two production plants located in Collepasso in the province of Lecce.

The two plants are designed in a modern and efficient work organization, with versatile and reliable production facilities which are managed following a quality management system certified according to the regulation ISO 9001:08 by TÜV.

STABILIMENTO PRODUZIONE FILTRI ARIA E MAGAZZINO CENTRALE LOGISTICA AIR FILTERS PRODUCTION PLANTS AND LOGISTIC WAREHOUSE

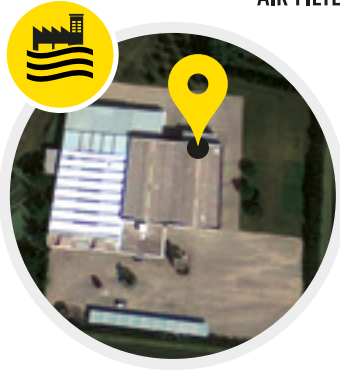

- Superficie totale 20.000 m²
- Superficie coperta 4.500 m²
- Una linea produzione filtri aria radiali
- Due linee produzione filtri aria pannello
- Magazzino centrale logistica

- Total area 20.000 m²
- Covered area 4.500 m²
- One production line of radial air filters
- Two production lines of panel air filters
- Logistic warehouse

STABILIMENTO PRODUZIONE FILTRI OLIO E FILTRI CARBURANTE OIL AND FUEL FILTERS PRODUCTION PLANTS

- Superficie totale 11.000 m²
- Superficie coperta 4.000 m²
- Una linea produzione filtri olio e filtri carburante spin-on
- Una linea produzione filtri olio e filtri carburante ecologici
- Un laboratorio controlli e test su materiali in entrata e prodotti finiti

- Total area 11.000 m²
- Covered area 4.000 m²
- One production line of oil and fuel spin-on filters
- One production line of oil and fuel ecological filters
- One laboratory for checks on incoming materials and finished products



CERTIFICAZIONI

Stabilimenti di produzione certificati secondo la norma UNI EN ISO 9001:2008

Campi di applicazione delle Certificazioni:

"PROGETTAZIONE E FABBRICAZIONE DI FILTRI ARIA PER MOTORI A COMBUSTIONE INTERNA"

"PROGETTAZIONE E FABBRICAZIONE DI FILTRI OLIO, FILTRI CARBURANTE PER MOTORI A COMBUSTIONE INTERNA"

CERTIFICATIONS

Production plants awarded by Management System Quality Certification UNI EN ISO 9001:2008

Certification is valid for the following products range:

"DESIGN AND MANUFACTURE OF AIR FILTERS FOR INTERNAL COMBUSTION ENGINES"

"DESIGN AND MANUFACTURE OF OIL FILTERS, FUEL FILTERS FOR INTERNAL COMBUSTION ENGINES"



Ultra-thin III
Filtration Technology



UNA PROTEZIONE INDISPENSABILE CONTRO LE POLVERI SOTTILI

FILTRI PARTICELLARI E COMBINATI CON CARBONI ATTIVI AD ALTA EFFICIENZA DI FILTRAZIONE

I filtri aria abitacolo particellari e combinati con carboni attivi TECNECO sono prodotti con l'impiego di media filtranti ad alta efficienza di filtrazione e con disposizione progressiva delle fibre, dallo strato di pre-filtrazione iniziale allo strato finale di copertura e protezione.

Struttura progressiva delle fibre significa che seguendo il senso di avanzamento dell'aria queste diminuiscono in dimensione e aumentano in densità e concentrazione. Viene così garantita una reale azione di filtrazione in profondità e un elevato immagazzinamento polveri garantendo contemporaneamente una buona permeabilità all'aria.

FILTRI PARTICELLARI

I filtri aria particellari TECNECO sono una reale ed affidabile protezione contro le particelle fini disperse nell'aria, le micropolveri fini respirabili, i pollini, le particelle da abrasione (freni - frizioni), le polveri stradali.

FILTRI COMBINATI CON CARBONI ATTIVI

I filtri aria abitacolo combinati con carboni attivi TECNECO hanno le stesse caratteristiche e proprietà dei filtri particellari ma in più sono muniti di uno strato di carboni attivi in grado di ridurre cattivi odori e gas pericolosi per la salute.

- Protezione da pollini, polveri sottili e ozono
- Eliminazione dei cattivi odori
- Visibilità chiara e nitida alla guida
- Protezione del sistema di riscaldamento e di aria condizionata dallo sporco

ASEPTIC BAG

Da sempre tutti i filtri abitacolo TECNECO, sia in fibra che combinati con carboni attivi, vengono conservati in un'apposita busta in nylon completamente asettica e poi scatola nel proprio pack in cartoncino. La scelta di conservare i filtri in una busta asettica e sigillata nasce dall'esigenza di fornire al mercato un prodotto che conservi nel tempo le sue qualità e caratteristiche, al fine di garantirne sempre una sua totale efficacia. Infatti, sia i filtri abitacolo in fibra che quelli combinati con carboni attivi, se non imbustati, perdono con il tempo le loro caratteristiche e funzionalità. I filtri abitacolo in fibra se non imbustati tendono a perdere col tempo la carica elettrostatica della fibra, che ha la funzione di trattenere le particelle inquinanti intercettate dal filtro.

La stessa cosa vale per i filtri combinati con i carboni attivi, che se non imbustati, rilasciano col passare del tempo i carboni attivi nell'ambiente, anche se non ancora installati sulla vettura.



FILTRI ABITACOLO IN BUSTA ASEPTICA PER GARANTIRNE QUALITÀ ED EFFICACIA

CABIN AIR FILTERS IN ASEPTIC BAG TO ENSURE QUALITY AND EFFECTIVENES

EVEN BETTER PROTECTION AGAINST FINE DUSTS

PARTICLE AND COMBI CABIN FILTERS WITH HIGH EFFICIENCY MEDIA'S

TECNECO particle and combi cabin filters consist of a multilayered filter medium. TECNECO filter media provides high arrestance, and is sandwiched by a pre-filter and a cover layer. The progressive structure, which means that fibre fineness and density increase towards the clean-air side. This ensures effective deep-bed filtration and even, maximised dust storage coupled with good air-permeability. The combi filter additionally features an adsorption layer made of activated carbon. TECNECO particle and combi filters achieve consistently high functional dependability even under the toughest of requirements.

THE PARTICLE FILTER

Reliable protection against fine dusts: thanks to optimised filter medias, Tecneco Filters particle filters provide the best state-of-the-art arrestance of respirable dusts, pollens, abraded particles and road dust.

THE COMBI FILTERS

In addition to the particle filters, it features a layer of activated carbon, enabling it to reduce unwanted odours and harmful gases. TECNECO combi filters provide a double function: health risks are minimised, driving comfort maximised.

- Protection against pollens, soot, fine dust
- Protection against unpleasant odors
- Enhanced visibility means more safety
- Protection of heating and ventilation systems against soiling, and thus extends their useful lifetimes

ASEPTIC BAG

Always all TECNECO cabin filters, both fiber and combined with activated carbon, are stored in a special nylon bag, completely aseptic and then boxed in cardboard pack. The choice to keep the filters in an aseptic and sealed bag stems from the need to provide to the market a product that retains over time its quality and characteristics, in order to always ensure its total effectiveness. In fact, both the cabin filters, fiber and combined with activated carbon, if not packed, lose over time their features and functionality. Fiber filters if not in bag, lose over time the electrostatic charge, which retains the contaminating particles intercepted by the filter. The carbon combi, if not packed, release the carbon in the environment, although not yet installed on the car.

PROTEZIONE, SICUREZZA ED ARIA PULITA PER GUIDATORE E PASSEGGERI

PROTEGGERE LA PROPRIA SALUTE CONTRO POLLINI E BATTERI, RESPIRARE ARIA PULITA, RIMUOVERE I CATTIVI ODORI

Il problema della qualità dell'aria in auto è oggi un argomento di discussione frequente ed indubbiamente di grande importanza. Come protezione efficace contro le sostanze nocive presenti nell'aria che respiriamo in auto, TECNECO offre due tipologie di filtri abitacolo: i filtri particellari e i filtri combinati.

FILTRI PARTICELLARI

I filtri particellari proteggono dalle polveri sottili, i pollini, la polvere stradale, le polveri da attrito e abrasione, la fuliggine, i batteri, le polveri industriali e altre polveri fini respirabili. Proteggono anche dai fumi di scarico dei veicoli con motore diesel che contengono particelle ultrafini e particelle carboniose di dimensioni inferiori a 2,5 micron di diametro. Le particelle di tali dimensioni difficilmente bloccabili dalle alte vie del nostro apparato respiratorio (come mucose delle cavità nasali e faringee e peli del naso) giungendo nei polmoni possono provocare vere e proprie infezioni polmonari e depositarvi sostanze tossiche di vario genere.

Queste sostanze inquinanti tendono a depositarsi in modo particolare nelle vie respiratorie più profonde e nei polmoni e sono causa di malattie respiratorie, malattie cardiovascolari ed asma. Soprattutto le persone che soffrono di allergie di tipo respiratorio, sono particolarmente a rischio se nell'abitacolo riescono a penetrare pollini nella stagione primaverile della fioritura. Irritazioni agli occhi, naso che cola, difficoltà respiratorie e attacchi di starnuti, riducono fortemente la concentrazione mentre si è alla guida dell'auto, aumentando il pericolo di incidenti stradali.

FILTRI COMBINATI CON CARBONI ATTIVI

I filtri abitacolo combinati con carboni attivi proteggono guidatore e passeggeri dalle stesse sostanze inquinanti contro cui agiscono i filtri particellari, ma in più grazie allo strato di carbone attivo di cui sono dotati, assorbono anche odori e gas, come per esempio benzene e ozono. Come le micropolveri, anche i gas, che hanno dimensioni di gran lunga inferiori, raggiungono le parti profonde del nostro apparato respiratorio. L'ozono, gas pericoloso e irritante, può causare reazioni come emicrania, tosse e stati di lacrimazione continua.

POTECTION, SAFETY AND CLEAN AIR FOR DRIVER AND PASSANGERS

PROTECT YOUR HELTH AGAINST POLLEN AND BACTERIA, BREATH CLEAN AIR, REMOVE UNPLEASANT ODORS

Pure clean air in cars has evolved into an important issue. As effective protection against pollutants, most particularly fine dusts, TECNECO is here offering two types of filter, each with synthetic fibre technology: particle and combi filters.

PARTICLE FILTERS

Particle filters protect against fine dusts, and also against pollens, road dust, abraded particles, soot, bacteria, industrial dusts and other respirable ultra-fine particles. Exhaust fumes from diesel vehicles contain fine dust and soot particles, smaller than 2,5 micrometers. This size of particle will not always be arrested by the mucus membranes in the nasal and pharyngeal cavities or by the nasal hairs. These particles are particularly health-hazardous, because they are able to trigger inflammations in the lung, and also transport toxic substances. Most of them are deposited in the lower respiratory tracts and the lungs. They are seen as a cause of respiratory deseases, cardio-vascular complaints and ashma. Carcinogenic effects are also attributed to them.

If pollens get inside the car unfiltered, allergy-sufferers are particularly at risk. Streaming eyes, dripping noses, shortness of breath or sneezing attacks reduce concentration levels and increase the accident risk.

COMBI FILTERS

The combi filters provides protection against the same pollutants as the particle filter - and that's not all it can do. Using a layer of activated carbon, it additionally adsorbs odours and gases, like benzene or ozone. Besides the small solid particles, the gases, smaller by a factor of ten milion, also penetrate as far as the deeper regions of the lung. The dangerous irritant gas ozone can cause reactions like headaches, coughing or streaming eyes. The activated-carbon layer in the TECNECO combi filters will break up to 99 percent of the ozone.



Fibra / Fiber



Multistrato fibra-carboni
Fiber-carbon multilayer

APPLICAZIONI PER CODICE
APPLICATIONS BY REFERENCES



CK 10025 Fiat Ford Chrysler Lancia	CK 10431 Citroen Mitsubishi Peugeot	CK 1611-C Daihatsu Subaru	CK 200-C Alfa Romeo	CK 2227 Chrysler Dodge Fiat Jeep Lancia	CK 24004-C Hyundai Kia	CK 26006 Seat Skoda Volkswagen	CK 2743-C Peugeot
CK 10025-C Fiat Ford Chrysler Lancia	CK 10431-C Citroen Mitsubishi Peugeot	CK 1629 Nissan Renault	CK 20006 Chrysler Fiat Lancia	CK 2227-C Chrysler Dodge Fiat Jeep Lancia	CK 24009 Mazda	CK 26008-2 Mazda	CK 2747-C Land Rover
CK 10055 Mercedes	CK 10436-10 Mercedes Volkswagen	CK 1629-C Nissan Renault	CK 20006-C Chrysler Fiat Lancia	CK 2230-C Mitsubishi	CK 24013 Hyundai Kia	CK 26009 Audi Seat Skoda Volkswagen	CK 28004 Toyota
CK 10055-C Mercedes	CK 10436-10-C Mercedes Volkswagen	CK 17001 Nissan Suzuki	CK 20010 Chevrolet/Daewoo	CK 224 Subaru	CK 2434 Kia	CK 26009-C Audi Seat Skoda Volkswagen	CK 2847-C Porsche Volkswagen
CK 10059 Ford Volvo	CK 10457 Audi Porche	CK 1719 Chevrolet/Daewoo	CK 20010-C Chevrolet/Daewoo	CK 2243 Alfa Romeo Citroen Fiat Opel/Vauxhall Peugeot	CK 2434-C Kia	CK 26010 Audi Seat Skoda Volkswagen	CK 29002-2 Hyundai
CK 10059-C Ford Volvo	CK 10457-C Audi Porche	CK 1721-2 Bmw Bmw Alpina	CK 20013 Citroen Peugeot Toyota	CK 2243-C Alfa Romeo Citroen Fiat Opel/Vauxhall Peugeot	CK 2436-10 Ford	CK 26010-C Audi Seat Skoda Volkswagen	CK 29002-C-2 Hyundai
CK 10062 Honda	CK 10474-2 Renault	CK 1811-2 Jeep Dodge	CK 20012 Chevrolet/Daewoo	CK 2243-C Alfa Romeo Citroen Fiat Opel/Vauxhall Peugeot	CK 25001-C Bmw Bmw Alpina	CK 26014-2 Peugeot	CK 29005-C Mercedes
CK 10067 Renault	CK 10474-C-2 Renault	CK 1811-C-2 Jeep Dodge	CK 20028-10 Opel/Vauxhall Suzuki	CK 2243-C Alfa Romeo Citroen Fiat Opel/Vauxhall Peugeot	CK 25002 Mercedes	CK 26014-C-2 Peugeot	CK 2941-2 Bmw
CK 10067-C Renault	CK 10529 Citroen Peugeot	CK 1827 Daihatsu Fiat Subaru Suzuki Toyota	CK 2030-C Jaguar	CK 2243-C Alfa Romeo Citroen Fiat Opel/Vauxhall Peugeot	CK 25003 Nissan	CK 26017 Hyundai Kia	CK 2941-C-2 Bmw
CK 10073-10 Honda	CK 10529-C Citroen Peugeot	CK 1830-C Mitsubishi Smart (Daimler AG)	CK 207 Citroen Peugeot Toyota	CK 2243-C Alfa Romeo Citroen Fiat Opel/Vauxhall Peugeot	CK 25007 Ford Volvo	CK 26017-C Hyundai Kia	CK 2952 Iveco
CK 10087 Land Rover	CK 10534-2 Mercedes Nissan Opel/Vauxhall Renault	CK 19001 Kia	CK 21003 Honda	CK 2243-C Alfa Romeo Citroen Fiat Opel/Vauxhall Peugeot	CK 25007-C Ford Volvo	CK 26017-C-2 Peugeot	CK 3124-10-2 Bmw
CK 10205-2 Citroen Peugeot	CK 19004-2 Bmw Bmw Alpina	CK 21009 Kia	CK 21009 Kia	CK 2243-C Alfa Romeo Citroen Fiat Opel/Vauxhall Peugeot	CK 25008-2 Hyundai	CK 26017-C-2 Peugeot	CK 3124-10-C-2 Bmw
CK 10205-C-2 Citroen Peugeot	CK 19004-C-2 Bmw Bmw Alpina	CK 2132-C Smart (Daimler AG)	CK 2132-C Smart (Daimler AG)	CK 2243-C Alfa Romeo Citroen Fiat Opel/Vauxhall Peugeot	CK 25008-C-2 Hyundai	CK 26017-C-2 Peugeot	CK 3139-2 Bmw
CK 10209-2 Audi Volkswagen	CK 2138 Suzuki	CK 2138-C Suzuki	CK 2138-C Suzuki	CK 2243-C Alfa Romeo Citroen Fiat Opel/Vauxhall Peugeot	CK 25012 Dacia Nissan Renault	CK 26017-C-2 Peugeot	CK 3139-C-2 Bmw
CK 10209-C-2 Audi Volkswagen	CK 2138-C Suzuki	CK 22001-2 Mazda	CK 2138-C Suzuki	CK 2243-C Alfa Romeo Citroen Fiat Opel/Vauxhall Peugeot	CK 25012-C Dacia Nissan Renault	CK 26017-C-2 Peugeot	CK 3139-C-2 Bmw
CK 10366-10 Citroen Fiat Peugeot Toyota	CK 22001-2 Mazda	CK 22004 Subaru	CK 2138-C Suzuki	CK 2243-C Alfa Romeo Citroen Fiat Opel/Vauxhall Peugeot	CK 2504 Fiat	CK 26017-C-2 Peugeot	CK 321 Fiat
CK 10366-10-C Citroen Fiat Peugeot Toyota	CK 22004 Subaru	CK 22011 Dacia Renault	CK 2138-C Suzuki	CK 2243-C Alfa Romeo Citroen Fiat Opel/Vauxhall Peugeot	CK 2506-2 Hyundai	CK 26017-C-2 Peugeot	CK 3435 Peugeot
CK 10411-10 Honda	CK 22011 Dacia Renault	CK 22011-C Dacia Renault	CK 2138-C Suzuki	CK 2243-C Alfa Romeo Citroen Fiat Opel/Vauxhall Peugeot	CK 2506-2 Hyundai	CK 26017-C-2 Peugeot	CK 3435-C Peugeot
CK 10411-10-C Honda	CK 22011-C Dacia Renault	CK 22013-C Ford	CK 2138-C Suzuki	CK 2243-C Alfa Romeo Citroen Fiat Opel/Vauxhall Peugeot	CK 2506-2 Hyundai	CK 26017-C-2 Peugeot	CK 3540 Mercedes
CK 10413-10 Citroen Fiat Opel/Vauxhall Peugeot	CK 22013-C Ford	CK 22013-C Ford	CK 2138-C Suzuki	CK 2243-C Alfa Romeo Citroen Fiat Opel/Vauxhall Peugeot	CK 2506-2 Hyundai	CK 26017-C-2 Peugeot	CK 3540-C Mercedes
CK 1177 Nissan	CK 22013-C Ford	CK 22013-C Ford	CK 2138-C Suzuki	CK 2243-C Alfa Romeo Citroen Fiat Opel/Vauxhall Peugeot	CK 2506-2 Hyundai	CK 26017-C-2 Peugeot	CK 384-C Peugeot
CK 1177-C Nissan	CK 22013-C Ford	CK 22013-C Ford	CK 2138-C Suzuki	CK 2243-C Alfa Romeo Citroen Fiat Opel/Vauxhall Peugeot	CK 2506-2 Hyundai	CK 26017-C-2 Peugeot	CK 421-2 Honda
CK 11743-C Ford	CK 22013-C Ford	CK 22013-C Ford	CK 2138-C Suzuki	CK 2243-C Alfa Romeo Citroen Fiat Opel/Vauxhall Peugeot	CK 2506-2 Hyundai	CK 26017-C-2 Peugeot	CK 421-C-2 Honda
CK 1936 Nissan	CK 22013-C Ford	CK 22013-C Ford	CK 2138-C Suzuki	CK 2243-C Alfa Romeo Citroen Fiat Opel/Vauxhall Peugeot	CK 2506-2 Hyundai	CK 26017-C-2 Peugeot	CK 4436 Mini
CK 1936-C Nissan	CK 22013-C Ford	CK 22013-C Ford	CK 2138-C Suzuki	CK 2243-C Alfa Romeo Citroen Fiat Opel/Vauxhall Peugeot	CK 2506-2 Hyundai	CK 26017-C-2 Peugeot	CK 4436-C Mini
CK 200 Alfa Romeo	CK 22013-C Ford	CK 22013-C Ford	CK 2138-C Suzuki	CK 2243-C Alfa Romeo Citroen Fiat Opel/Vauxhall Peugeot	CK 2506-2 Hyundai	CK 26017-C-2 Peugeot	CK 5366 Bmw Land Rover
CK 200 Alfa Romeo	CK 22013-C Ford	CK 22013-C Ford	CK 2138-C Suzuki	CK 2243-C Alfa Romeo Citroen Fiat Opel/Vauxhall Peugeot	CK 2506-2 Hyundai	CK 26017-C-2 Peugeot	CK 5366-C Bmw Land Rover
CK 200 Alfa Romeo	CK 22013-C Ford	CK 22013-C Ford	CK 2138-C Suzuki	CK 2243-C Alfa Romeo Citroen Fiat Opel/Vauxhall Peugeot	CK 2506-2 Hyundai	CK 26017-C-2 Peugeot	CK 5474 Volkswagen
CK 200 Alfa Romeo	CK 22013-C Ford	CK 22013-C Ford	CK 2138-C Suzuki	CK 2243-C Alfa Romeo Citroen Fiat Opel/Vauxhall Peugeot	CK 2506-2 Hyundai	CK 26017-C-2 Peugeot	CK 5474 Volkswagen

CK 5475 Bedford Opel/Vauxhall	CK 5823-C Alfa Romeo Fiat Lancia	CK 5893-C Renault	CK 8832-2 Renault	CK 9293-C Renault	CK 9399 Honda	CK 9586 Citroen Fiat Lancia Peugeot	CK 9825-C-2 Mercedes
CK 5475-C Bedford Opel/Vauxhall	CK 5824 Audi	CK 5935 Bmw	CK 8838 Nissan Renault	CK 9294 Citroen Peugeot	CK 9405-2 Alfa Romeo		CK 9827 Renault
CK 5551 Citroen Peugeot	CK 5824-C Audi	CK 5942 Audi	CK 8838-C Nissan Renault	CK 9294-C Citroen Peugeot	CK 9405-C-2 Alfa Romeo	CK 9586-C Citroen Fiat Lancia Peugeot	CK 9827-C Renault
CK 5662 Audi Volkswagen	CK 5841 Alfa Romeo Fiat Lancia Saab	CK 5972-2 Mercedes	CK 8867 Opel/Vauxhall	CK 9322-2 Bmw	CK 9406-C Citroen	CK 9594 Mini	CK 9832-2 Chevrolet/Daewoo
CK 5662-C Audi Volkswagen	CK 5842 Chrysler Mercedes	CK 5990 Seat Volkswagen	CK 8867-C Opel/Vauxhall	CK 9322-C-2 Bmw	CK 9408 Fiat Lancia	CK 9594-C Mini	CK 9846 Lexus Subaru Toyota
CK 5663 Audi Seat Skoda Volkswagen	CK 5842-C Chrysler Mercedes	CK 619-C Jaguar	CK 8868 Opel/Vauxhall	CK 9323 Audi Mercedes Seat Skoda Volkswagen	CK 9408-C Fiat Lancia	CK 9595 Renault	CK 9880 Mitsubishi Volvo
CK 5663-C Audi Seat Skoda Volkswagen	CK 5845 Peugeot	CK 77366480 Fiat Jeep	CK 8868-C Opel/Vauxhall	CK 9323-C Audi Mercedes Seat Skoda Volkswagen	CK 9408/1-C Fiat Lancia	CK 9640 Rover	CK 9881 Audi Porsche Volkswagen
CK 5664 Ford Jaguar	CK 5846 Peugeot Porsche	CK 77366480-C Fiat Jeep	CK 8869-C Audi Seat Volkswagen	CK 9335 Opel/Vauxhall Subaru Suzuki	CK 9414 Volkswagen	CK 9640-C Rover	CK 9881-C Audi Porsche Volkswagen
CK 5664-C Ford Jaguar	CK 5846-C Peugeot Porsche	CK 8103 Bmw	CK 8890 Citroen Fiat Peugeot	CK 9336 Volvo	CK 9414-C Volkswagen	CK 9645 Audi Seat	CK 9882 Infiniti Nissan
CK 5665 Opel/Vauxhall	CK 5847 Renault	CK 8430 Bmw Bmw Alpina	CK 8912-2 Bmw	CK 9336-C Volvo	CK 9442 Renault	CK 9645-C Audi Seat	CK 9882-C Infiniti Nissan
CK 5665-C Opel/Vauxhall	CK 5847-C Renault	CK 8430-C Bmw Bmw Alpina	CK 8912-C-2 Bmw	CK 9337 Ford Nissan	CK 9442-C Renault	CK 9659 Toyota	CK 9904 Opel/Vauxhall
CK 5816 Opel/Vauxhall	CK 5848 Renault	CK 8714 Volvo	CK 8913 Bmw	CK 9337 Ford Nissan	CK 9445-C Smart	CK 9665 Mazda	CK 9904-C Opel/Vauxhall
CK 5816-C Opel/Vauxhall	CK 5848-C Renault	CK 8714-C Volvo	CK 8913-C Bmw	CK 9338 Honda Rover	CK 9466 Subaru Toyota	CK 9665-C Mazda	CK 9905 Mercedes
CK 5817 Ford Mazda	CK 5850 Ford Seat Volkswagen	CK 8717 Mercedes	CK 8914-2 Opel/Vauxhall	CK 9338 Honda Rover	CK 9485 Ford	CK 9666 Ford	CK 9905-C Mercedes
CK 5817-C Ford Mazda	CK 5850-C Ford Seat Volkswagen	CK 8717-C Mercedes	CK 8947-3 Citroen Fiat Lancia Peugeot	CK 9363 Luxus Nissan	CK 9495 Fiat Opel/Vauxhall Saab	CK 9666-C Ford	CK 9907 Saab
CK 5818 Fiat Lancia	CK 5851 Alfa Romeo Lancia Maserati	CK 8719 Land Rover	CK 8989 Fiat	CK 9364 Renault	CK 9495-C Fiat Opel/Vauxhall Saab	CK 9686 Toyota	CK 9920-C Citroen Peugeot
CK 5818-C Fiat Lancia	CK 5851-C Alfa Romeo Lancia Maserati	CK 8750 Citroen	CK 9051 Mercedes Volkswagen	CK 9364-C Renault	CK 9533 Fiat Lancia	CK 9691 Dacia Nissan Renault	CK 9920-C Citroen Peugeot
CK 5819 Alfa Romeo Fiat Iveco Lancia	CK 5852-3 Ford	CK 8777 Mercedes	CK 9051-C Mercedes Volkswagen	CK 9383 Mercedes	CK 9533-C Fiat Lancia	CK 9724 Saab	CK 9922 Audi Seat Skoda Volkswagen
CK 5819-C Alfa Romeo Fiat Iveco Lancia	CK 5863-C Opel/Vauxhall	CK 8777-C Mercedes	CK 9071 Peugeot	CK 9394 Chevrolet/Daewoo Renault	CK 9545 Renault	CK 9742 Nissan Renault	CK 9922-C Audi Seat Skoda Volkswagen
CK 5823 Alfa Romeo Fiat Lancia	CK 5864 Peugeot	CK 8778-C Saab	CK 9071-C Peugeot	CK 9395 Chevrolet/Daewoo	CK 9546 Renault	CK 9742 Nissan Renault	CK 9922-C Audi Seat Skoda Volkswagen
	CK 5865 Honda Rover	CK 879 Mercedes	CK 9077 Fiat	CK 9396 Volvo	CK 9562 Citroen	CK 9756 Hyundai Kia	CK 9922-C Audi Seat Skoda Volkswagen
	CK 5865 Honda Rover	CK 879-C Mercedes	CK 9077-C Fiat	CK 9396-C Volvo	CK 9562-C Citroen	CK 9756 Hyundai Kia	CK 9922-C Audi Seat Skoda Volkswagen
	CK 5865 Honda Rover	CK 8799 Renault	CK 921-2 Citroen Peugeot	CK 9398 Citroen Peugeot	CK 9562-C Citroen	CK 9785 Mercedes	CK 9922-C Audi Seat Skoda Volkswagen
	CK 5865 Honda Rover	CK 8831 Ford	CK 9293 Renault	CK 9398-C Citroen Peugeot	CK 9562-C Citroen	CK 9787 Ford	CK 9922-C Audi Seat Skoda Volkswagen
	CK 5865 Honda Rover	CK 8831-C Ford			CK 9562-C Citroen	CK 9787-C Ford	CK 9922-C Audi Seat Skoda Volkswagen
	CK 5865 Honda Rover	CK 8831-C Ford			CK 9562-C Citroen	CK 9787-C Ford	CK 9922-C Audi Seat Skoda Volkswagen
	CK 5865 Honda Rover	CK 8831-C Ford			CK 9562-C Citroen	CK 9787-C Ford	CK 9922-C Audi Seat Skoda Volkswagen
	CK 5865 Honda Rover	CK 8831-C Ford			CK 9562-C Citroen	CK 9787-C Ford	CK 9922-C Audi Seat Skoda Volkswagen
	CK 5865 Honda Rover	CK 8831-C Ford			CK 9562-C Citroen	CK 9787-C Ford	CK 9922-C Audi Seat Skoda Volkswagen
	CK 5865 Honda Rover	CK 8831-C Ford			CK 9562-C Citroen	CK 9787-C Ford	CK 9922-C Audi Seat Skoda Volkswagen
	CK 5865 Honda Rover	CK 8831-C Ford			CK 9562-C Citroen	CK 9787-C Ford	CK 9922-C Audi Seat Skoda Volkswagen
	CK 5865 Honda Rover	CK 8831-C Ford			CK 9562-C Citroen	CK 9787-C Ford	CK 9922-C Audi Seat Skoda Volkswagen
	CK 5865 Honda Rover	CK 8831-C Ford			CK 9562-C Citroen	CK 9787-C Ford	CK 9922-C Audi Seat Skoda Volkswagen
	CK 5865 Honda Rover	CK 8831-C Ford			CK 9562-C Citroen	CK 9787-C Ford	CK 9922-C Audi Seat Skoda Volkswagen
	CK 5865 Honda Rover	CK 8831-C Ford			CK 9562-C Citroen	CK 9787-C Ford	CK 9922-C Audi Seat Skoda Volkswagen
	CK 5865 Honda Rover	CK 8831-C Ford			CK 9562-C Citroen	CK 9787-C Ford	CK 9922-C Audi Seat Skoda Volkswagen
	CK 5865 Honda Rover	CK 8831-C Ford			CK 9562-C Citroen	CK 9787-C Ford	CK 9922-C Audi Seat Skoda Volkswagen
	CK 5865 Honda Rover	CK 8831-C Ford			CK 9562-C Citroen	CK 9787-C Ford	CK 9922-C Audi Seat Skoda Volkswagen
	CK 5865 Honda Rover	CK 8831-C Ford			CK 9562-C Citroen	CK 9787-C Ford	CK 9922-C Audi Seat Skoda Volkswagen
	CK 5865 Honda Rover	CK 8831-C Ford			CK 9562-C Citroen	CK 9787-C Ford	CK 9922-C Audi Seat Skoda Volkswagen
	CK 5865 Honda Rover	CK 8831-C Ford			CK 9562-C Citroen	CK 9787-C Ford	CK 9922-C Audi Seat Skoda Volkswagen
	CK 5865 Honda Rover	CK 8831-C Ford			CK 9562-C Citroen	CK 9787-C Ford	CK 9922-C Audi Seat Skoda Volkswagen
	CK 5865 Honda Rover	CK 8831-C Ford			CK 9562-C Citroen	CK 9787-C Ford	CK 9922-C Audi Seat Skoda Volkswagen
	CK 5865 Honda Rover	CK 8831-C Ford			CK 9562-C Citroen	CK 9787-C Ford	CK 9922-C Audi Seat Skoda Volkswagen
	CK 5865 Honda Rover	CK 8831-C Ford			CK 9562-C Citroen	CK 9787-C Ford	CK 9922-C Audi Seat Skoda Volkswagen
	CK 5865 Honda Rover	CK 8831-C Ford			CK 9562-C Citroen	CK 9787-C Ford	CK 9922-C Audi Seat Skoda Volkswagen
	CK 5865 Honda Rover	CK 8831-C Ford			CK 9562-C Citroen	CK 9787-C Ford	CK 9922-C Audi Seat Skoda Volkswagen
	CK 5865 Honda Rover	CK 8831-C Ford			CK 9562-C Citroen	CK 9787-C Ford	CK 9922-C Audi Seat Skoda Volkswagen
	CK 5865 Honda Rover	CK 8831-C Ford			CK 9562-C Citroen	CK 9787-C Ford	CK 9922-C Audi Seat Skoda Volkswagen
	CK 5865 Honda Rover	CK 8831-C Ford			CK 9562-C Citroen	CK 9787-C Ford	CK 9922-C Audi Seat Skoda Volkswagen
	CK 5865 Honda Rover	CK 8831-C Ford			CK 9562-C Citroen	CK 9787-C Ford	CK 9922-C Audi Seat Skoda Volkswagen
	CK 5865 Honda Rover	CK 8831-C Ford			CK 9562-C Citroen	CK 9787-C Ford	CK 9922-C Audi Seat Skoda Volkswagen
	CK 5865 Honda Rover	CK 8831-C Ford			CK 9562-C Citroen	CK 9787-C Ford	CK 9922-C Audi Seat Skoda Volkswagen
	CK 5865 Honda Rover	CK 8831-C Ford			CK 9562-C Citroen	CK 9787-C Ford	CK 9922-C Audi Seat Skoda Volkswagen
	CK 5865 Honda Rover	CK 8831-C Ford			CK 9562-C Citroen	CK 9787-C Ford	CK 9922-C Audi Seat Skoda Volkswagen
	CK 5865 Honda Rover	CK 8831-C Ford			CK 9562-C Citroen	CK 9787-C Ford	CK 9922-C Audi Seat Skoda Volkswagen
	CK 5865 Honda Rover	CK 8831-C Ford			CK 9562-C Citroen	CK 9787-C Ford	CK 9922-C Audi Seat Skoda Volkswagen
	CK 5865 Honda Rover	CK 8831-C Ford			CK 9562-C Citroen	CK 9787-C Ford	CK 9922-C Audi Seat Skoda Volkswagen
	CK 5865 Honda Rover	CK 8831-C Ford			CK 9562-C Citroen	CK 9787-C Ford	CK 9922-C Audi Seat Skoda Volkswagen
	CK 5865 Honda Rover	CK 8831-C Ford			CK 9562-C Citroen	CK 9787-C Ford	CK 9922-C Audi Seat Skoda Volkswagen
	CK 5865 Honda Rover	CK 8831-C Ford			CK 9562-C Citroen	CK 9787-C Ford	CK 9922-C Audi Seat Skoda Volkswagen
	CK 5865 Honda Rover	CK 8831-C Ford			CK 9562-C Citroen	CK 9787-C Ford	CK 9922-C Audi Seat Skoda Volkswagen
	CK 5865 Honda Rover	CK 8831-C Ford			CK 9562-C Citroen	CK 9787-C Ford	CK 9922-C Audi Seat Skoda Volkswagen
	CK 5865 Honda Rover	CK 8831-C Ford			CK 9562-C Citroen	CK 9787-C Ford	CK 9922-C Audi Seat Skoda Volkswagen
	CK 5865 Honda Rover	CK 8831-C Ford			CK 9562-C Citroen	CK 9787-C Ford	CK 9922-C Audi Seat Skoda Volkswagen
	CK 5865 Honda Rover	CK 8831-C Ford			CK 9562-C Citroen	CK 9787-C Ford	CK 9922-C Audi Seat Skoda Volkswagen
	CK 5865 Honda Rover	CK 8831-C Ford			CK 9562-C Citroen	CK 9787-C Ford	CK 9922-C Audi Seat Skoda Volkswagen
	CK 5865 Honda Rover	CK 8831-C Ford			CK 9562-C Citroen	CK 9787-C Ford	CK 9922-C Audi Seat Skoda Volkswagen
	CK 5865 Honda Rover	CK 8831-C Ford			CK 9562-C Citroen	CK 9787-C Ford	CK 9922-C Audi Seat Skoda Volkswagen
	CK 5865 Honda Rover	CK 8831-C Ford			CK 9562-C Citroen	CK 9787-C Ford	CK 9922-C Audi Seat Skoda Volkswagen
	CK 5865 Honda Rover	CK 8831-C Ford			CK 9562-C Citroen	CK 9787-C Ford	CK 9922-C Audi Seat Skoda Volkswagen
	CK 5865 Honda Rover	CK 8831-C Ford			CK 9562-C Citroen	CK 9787-C Ford	CK 9922-C Audi Seat Skoda Volkswagen
	CK 5865 Honda Rover	CK 8831-C Ford			CK 9562-C Citroen	CK 9787-C Ford	CK 9922-C Audi Seat Skoda Volkswagen
	CK 5865 Honda Rover	CK 8831-C Ford			CK 9562-C Citroen	CK 9787-C Ford	CK 9922-C Audi Seat Skoda Volkswagen
	CK 5865 Honda Rover	CK 8831-C Ford			CK 9562-C Citroen	CK 9787-C Ford	CK 99

APPLICAZIONI PER COSTRUTTORI
APPLICATIONS BY MAKERS









Anti-pollen

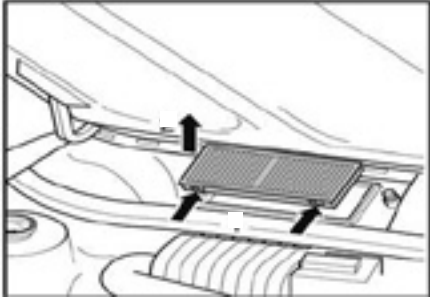

Activated carbon

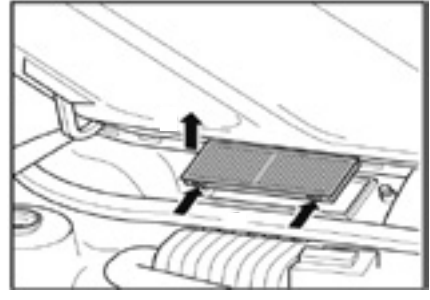

ALFA ROMEO

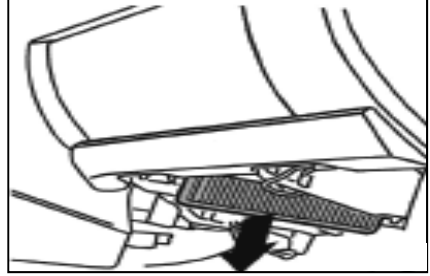
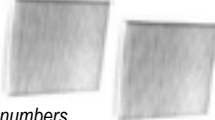
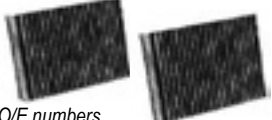
<p>--- 145 ---</p>  <p> 1 Il filtro è posizionato nel vano motore dietro la presa d'aria 2 The filter is located in the engine compartment behind the ventilation grilles 3 Le filtre est situé dans le compartiment moteur derrière les grilles d'aération 4 Der filter befindet sich im Motorraum hinter den Lüftungsgittern 5 El filtro se encuentra en el compartimiento del motor, detrás de la rejilla de ventilación </p>	<p>10/94 -> 01/01</p> <p>*</p>	<p>CK 5823 385 x 173 x 20</p>  <p><u>O/E numbers</u> Alfa Romeo 46721923 / 60809709</p> <p><u>Cross References</u> Fram CF5823 Mann CU3942 Micronair MP050 Purflux AH110/AH121 Tecnocar E314 Fiaam PC8013</p>	<p>CK 5823-C 385 x 173 x 20</p>  <p><u>O/E numbers</u> Alfa Romeo 46721923</p> <p><u>Cross References</u> Fram CFA8881 Mann..... Micronair MC550 Purflux..... Tecnocar..... Fiaam PCK8070</p>
--	-----------------------------------	---	--

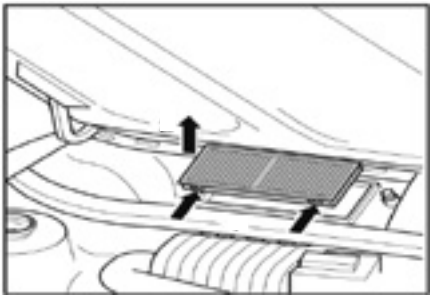
<p>--- 146 ---</p>  <p> 1 Il filtro è posizionato nel vano motore dietro la presa d'aria 2 The filter is located in the engine compartment behind the ventilation grilles 3 Le filtre est situé dans le compartiment moteur derrière les grilles d'aération 4 Der filter befindet sich im Motorraum hinter den Lüftungsgittern 5 El filtro se encuentra en el compartimiento del motor, detrás de la rejilla de ventilación </p>	<p>12/94 -> 01/01</p> <p>*</p>	<p>CK 5823 385 x 173 x 20</p>  <p><u>O/E numbers</u> Alfa Romeo 46721923 / 60809709</p> <p><u>Cross References</u> Fram CF5823 Mann CU3942 Micronair MP050 Purflux AH110/AH121 Tecnocar E314 Fiaam PC8013</p>	<p>CK 5823-C 385 x 173 x 20</p>  <p><u>O/E numbers</u> Alfa Romeo 46721923</p> <p><u>Cross References</u> Fram CFA8881 Mann..... Micronair MC550 Purflux..... Tecnocar..... Fiaam PCK8070</p>
--	-----------------------------------	---	--

<p>--- 147 ---</p>  <p> 1 Il filtro è posizionato nell'abitacolo sotto il vano portaoggetti 2 The filter is located in the passenger compartment under the glove compartment 3 Le filtre est situé dans l'habitacle en dessous de la boîte à gants 4 Der filter befindet sich im Fahrgastraum unter dem Handshuhfach 5 El filtro se encuentra en el habitáculo, bajo la guantera de pasajerruimte </p>	<p>11/00 -></p> <p>*</p>	<p>CK 9405-2 175 x 138 x 30,5</p>  <p><u>O/E numbers</u> Alfa Romeo 71754154</p> <p><u>Cross References</u> Fram Mann Micronair MP095-2 Purflux Tecnocar Fiaam</p>	<p>CK 9405-C-2 175 x 138 x 30,5</p>  <p><u>O/E numbers</u> Alfa Romeo 46799653</p> <p><u>Cross References</u> Fram CFA9405 Mann CUK1820-2 Micronair MC595-2 Purflux AHC177 Tecnocar EC380 Fiaam PCK8090</p>
--	-----------------------------	--	--

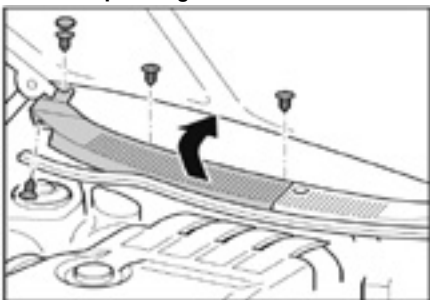
<p>--- 155 ---</p>  <p> 1 Il filtro è posizionato nel vano motore dietro la presa d'aria 2 The filter is located in the engine compartment behind the ventilation grilles 3 Le filtre est situé dans le compartiment moteur derrière les grilles d'aération 4 Der filter befindet sich im Motorraum hinter den Lüftungsgittern 5 El filtro se encuentra en el compartimiento del motor, detrás de la rejilla de ventilación </p>	<p>02/92 -> 07/98</p> <p>*</p>	<p>CK 5823 385 x 173 x 20</p>  <p><u>O/E numbers</u> Alfa Romeo 46721923 / 60809709</p> <p><u>Cross References</u> Fram CF5823 Mann CU3942 Micronair MP050 Purflux AH110 Tecnocar E314 Fiaam PC8013</p>	<p>CK 5823-C 385 x 173 x 20</p>  <p><u>O/E numbers</u> Alfa Romeo 46721923</p> <p><u>Cross References</u> Fram CFA8881 Mann..... Micronair MC550 Purflux AH110 Tecnocar..... Fiaam PCK8070</p>
--	-----------------------------------	---	---

<p>--- 156 + Sportwagon ---</p>  <p> 1 Il filtro è posizionato nel vano motore dietro la presa d'aria 2 The filter is located in the engine compartment behind the ventilation grilles 3 Le filtre est situé dans le compartiment moteur derrière les grilles d'aération 4 Der filter befindet sich im Motorraum hinter den Lüftungsgittern 5 El filtro se encuentra en el compartimiento del motor, detrás de la rejilla de ventilación </p>	<p>09/97 -> 01/02</p> <p>*</p>	<p>CK 5819 290 x 160 x 29</p>  <p><u>O/E numbers</u> Alfa Romeo 587820100</p> <p><u>Cross References</u> Fram CF5819 Mann CU2951/CU2956 Micronair MP039 Purflux AH107 Tecnocar E305 Fiaam PC8011</p>	<p>CK 5819-C 290 x 160 x 29</p>  <p><u>O/E numbers</u> Alfa Romeo 60653641</p> <p><u>Cross References</u> Fram CFA8894 Mann CU2951/CU2956 Micronair MC539 Purflux AHC107 Tecnocar EC305 Fiaam PCK8068</p>
---	-----------------------------------	--	--



Anti-pollen

Activated carbon

ALFA ROMEO

<p>--- 156 + Sportwagon ---</p>	02/02 ->	*		<p>CK 9405-2 175 x 140 x 30,5</p> <p><u>O/E numbers</u> Alfa Romeo 71754154</p> <p><u>Cross References</u> Fram Mann Micronair MP095-2 Purflux Tecnocar Fiaam</p>	<p>CK 9405-C-2 175 x 140 x 30,5</p> <p><u>O/E numbers</u> Alfa Romeo 46799653</p> <p><u>Cross References</u> Fram CFA9405 Mann CUK1820-2 Micronair MC595-2 Purflux AHC177 Tecnocar EC380 Fiaam PCK8090</p>
	<p>Il filtro è posizionato nell'abitacolo sotto il vano portaoggetti</p> <p>The filter is located in the passenger compartment under the glove compartment</p> <p>Le filtre est situé dans l'habitacle en dessous de la boîte à gants</p> <p>Der filter befindet sich im Fahrgastraum unter dem Handshuhfach</p> <p>El filtro se encuentra en el habitáculo, bajo la guantera de pasajerruimte</p>				

<p>--- 159 ---</p>	06/05 ->	*		<p>CK 200 216 x 200 x 30</p> <p><u>O/E numbers</u> Alfa Romeo 77363481 / 52408346</p> <p><u>Cross References</u> Fram CF10200 Mann CU2232 Micronair MP200 Purflux AH250 Tecnocar E446 Fiaam PC8174</p>	<p>CK 200-C 216 x 200 x 30</p> <p><u>O/E numbers</u> Alfa Romeo 77363370 / 52407563</p> <p><u>Cross References</u> Fram CFA10199 Mann CUK2232 Micronair MC700 Purflux AHC250 Tecnocar EC446 Fiaam PCK8175</p>
	<p>Il filtro è posizionato nell'abitacolo dietro il vano portaoggetti</p> <p>The filter is located in the passenger compartment behind the glove compartment</p> <p>Le filtre est situé dans l'habitacle derrière la boîte à gants</p> <p>Der filter befindet sich im Fahrgastraum hinter dem Handshuhfach</p> <p>El filtro se encuentra en el habitáculo detrás de la guantera</p>				

<p>--- 164 ---</p>	06/87 -> 09/98	*		<p>CK 5841 286 x 224 x 13</p> <p><u>O/E numbers</u> Alfa Romeo 60801430 / 7797229</p> <p><u>Cross References</u> Fram CF5841 Mann CU3136 Micronair MP027 Purflux AH109 Tecnocar E304 Fiaam PC8008</p>	
	<p>Il filtro è posizionato nel vano motore sul lato passeggero</p> <p>The filter is located in the engine compartment on the passenger's side</p> <p>Le filtre est situé dans le compartiment moteur du côté passager</p> <p>Der filter befindet sich Motorraum auf der Beifahrerseite</p> <p>El filtro se encuentra en el compartimiento del motor, del lado del acompañante</p>				

<p>--- 166 ---</p>	10/98 ->	*		<p>CK 5851 293 x 225 x 20</p> <p><u>O/E numbers</u> Alfa Romeo 46721047</p> <p><u>Cross References</u> Fram CF5851 Mann CU3042 Micronair MP016 Purflux AH111 Tecnocar E303 Fiaam PC8025</p>	<p>CK 5851-C 293 x 225 x 20</p> <p><u>O/E numbers</u> Alfa Romeo 60814643 / 46722335</p> <p><u>Cross References</u> Fram CFA8788 Mann CUK3042 Micronair MC591 Purflux AHC156 Tecnocar EC355 Fiaam PCK8036</p>
	<p>Il filtro è posizionato nel vano motore sul lato passeggero</p> <p>The filter is located in the engine compartment on the passenger's side</p> <p>Le filtre est situé dans le compartiment moteur du côté passager</p> <p>Der filter befindet sich Motorraum auf der Beifahrerseite</p> <p>El filtro se encuentra en el compartimiento del motor, del lado del acompañante</p>				

<p>--- Brera ---</p>	09/05 ->	*		<p>CK 200 216 x 200 x 30</p> <p><u>O/E numbers</u> Alfa Romeo 77363481 / 52408346</p> <p><u>Cross References</u> Fram CF10200 Mann CU2232 Micronair MP200 Purflux AH250 Tecnocar E446 Fiaam PC8174</p>	<p>CK 200-C 216 x 200 x 30</p> <p><u>O/E numbers</u> Alfa Romeo 77363370 / 52407563</p> <p><u>Cross References</u> Fram CFA10199 Mann CUK2232 Micronair MC700 Purflux AHC250 Tecnocar EC446 Fiaam PCK8175</p>
	<p>Il filtro è posizionato nell'abitacolo dietro il vano portaoggetti</p> <p>The filter is located in the passenger compartment behind the glove compartment</p> <p>Le filtre est situé dans l'habitacle derrière la boîte à gants</p> <p>Der filter befindet sich im Fahrgastraum hinter dem Handshuhfach</p> <p>El filtro se encuentra en el habitáculo detrás de la guantera</p>				



Anti-pollen

Activated carbon

ALFA ROMEO

<p>--- Crosswagon Q4 ---</p>	<p>07/04 -> 05/06</p>	<p>*</p>	<p>CK 9405-2 175 x 140 x 30,5</p> <p><u>O/E numbers</u> Alfa Romeo 71754154</p> <p><u>Cross References</u> Fram Mann Micronair MP095-2 Purflux Tecnocar Fiaam</p>	<p>CK 9405-C-2 175 x 140 x 30,5</p> <p><u>O/E numbers</u> Alfa Romeo 46799653</p> <p><u>Cross References</u> Fram CFA9405 Mann CUK1820-2 Micronair MC595-2 Purflux AHC177 Tecnocar EC380 Fiaam PCK8090</p>
	<p>Il filtro è posizionato nell'abitacolo sotto il vano portaoggetti</p> <p>The filter is located in the passenger compartment under the glove compartment</p> <p>Le filtre est situé dans l'habitacle en dessous de la boîte à gants</p> <p>Der filter befindet sich im Fahrgastraum unter dem Handshuhfach</p> <p>El filtro se encuentra en el habitáculo, bajo la guantera de pasajero</p>			

<p>--- Giulietta ---</p>	<p>05/10 -></p>	<p>*</p>	<p>CK 2347 216 x 200 x 30</p> <p><u>O/E numbers</u> Alfa Romeo 77365352</p> <p><u>Cross References</u> Fram CF11152 Mann CU23009 Micronair MP390 Purflux AH330 Tecnocar E624 Fiaam PC8290</p>	
	<p>Il filtro è posizionato nell'abitacolo dietro il vano portaoggetti</p> <p>The filter is located in the passenger compartment behind the glove compartment</p> <p>Le filtre est situé dans l'habitacle derrière la boîte à gants</p> <p>Der filter befindet sich im Fahrgastraum hinter dem Handshuhfach</p> <p>El filtro se encuentra en el habitáculo detrás de la guantera</p>			

<p>--- GT ---</p>	<p>02/04 -> 09/10</p>	<p>*</p>	<p>CK 9405-2 175 x 138 x 30,5</p> <p><u>O/E numbers</u> Alfa Romeo 71754154</p> <p><u>Cross References</u> Fram Mann Micronair MP095-2 Purflux Tecnocar Fiaam</p>	<p>CK 9405-C-2 175 x 138 x 30,5</p> <p><u>O/E numbers</u> Alfa Romeo 46799653</p> <p><u>Cross References</u> Fram CFA9405 Mann CUK1820-2 Micronair MC595-2 Purflux AHC177 Tecnocar EC380 Fiaam PCK8090</p>
	<p>Il filtro è posizionato nell'abitacolo sotto il vano portaoggetti</p> <p>The filter is located in the passenger compartment under the glove compartment</p> <p>Le filtre est situé dans l'habitacle en dessous de la boîte à gants</p> <p>Der filter befindet sich im Fahrgastraum unter dem Handshuhfach</p> <p>El filtro se encuentra en el habitáculo, bajo la guantera de pasajero</p>			

<p>--- GTV ---</p>	<p>04/95 -></p>	<p>*</p>	<p>CK 5823 385 x 173 x 20</p> <p><u>O/E numbers</u> Alfa Romeo 46721923 / 60809709</p> <p><u>Cross References</u> Fram CF5823 Mann CU3942 Micronair MP050 Purflux AH110/AH121 Tecnocar E314 Fiaam PC8013</p>	<p>CK 5823-C 385 x 173 x 20</p> <p><u>O/E numbers</u> Alfa Romeo 46721923</p> <p><u>Cross References</u> Fram CFA8881 Mann..... Micronair MC550 Purflux..... Tecnocar..... Fiaam PCK8070</p>
	<p>Il filtro è posizionato nel vano motore sul lato passeggero</p> <p>The filter is located in the engine compartment on the passenger's side</p> <p>Le filtre est situé dans le compartiment moteur du côté passager</p> <p>Der filter befindet sich Motorraum auf der Beifahrerseite</p> <p>El filtro se encuentra en el compartimiento del motor, del lado del acompañante</p>			

<p>--- Mito ---</p>	<p>07/08 -></p>	<p>*</p>	<p>CK 2243 265 x 217 x 20,5</p> <p><u>O/E numbers</u> Alfa Romeo 55702456</p> <p><u>Cross References</u> Fram CF10282 Mann CU2243 Micronair MP193 Purflux AH244 Tecnocar E465 Fiaam PC8170</p>	<p>CK 2243-C 265 x 217 x 20,5</p> <p><u>O/E numbers</u> Alfa Romeo 55702468</p> <p><u>Cross References</u> Fram CFA10365 Mann CUK2243 Micronair MC693 Purflux AHC244 Tecnocar EC465 Fiaam PCK8194</p>
	<p>Il filtro è posizionato nell'abitacolo dietro il vano portaoggetti</p> <p>The filter is located in the passenger compartment behind the glove compartment</p> <p>Le filtre est situé dans l'habitacle derrière la boîte à gants</p> <p>Der filter befindet sich im Fahrgastraum hinter dem Handshuhfach</p> <p>El filtro se encuentra en el habitáculo detrás de la guantera</p>			





Anti-pollen

Activated carbon

ALFA ROMEO

--- Spider ---

06/95 ->

*

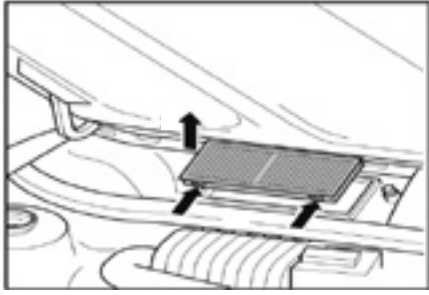

- I** Il filtro è posizionato nel vano motore sul lato passeggero
- GB** The filter is located in the engine compartment on the passenger's side
- F** Le filtre est situé dans le compartiment moteur du côté passager
- D** Der filter befindet sich Motorraum auf der Beifahrerseite
- E** El filtro se encuentra en el compartimiento del motor, del lado del acompañante

CK 5823

385 x 173 x 20



O/E numbers

Alfa Romeo 46721923 / 60809709

Cross References

Fram CF5823	Mann CU3942
Micronair MP050	Purflux AH110/AH121
Tecnocar E314	Fiaam PC8013

CK 5823-C

385 x 173 x 20



O/E numbers

Alfa Romeo 46721923

Cross References

Fram CFA8881	Mann.....
Micronair MC550	Purflux.....
Tecnocar.....	Fiaam PCK8070

--- Spider ---

07/06 ->

*



- I** Il filtro è posizionato nell'abitacolo dietro il vano portaoggetti
- GB** The filter is located in the passenger compartment behind the glove compartment
- F** Le filtre est situé dans l'habitacle derrière la boîte à gants
- D** Der filter befindet sich im Fahrgastraum hinter dem Handshuhfach
- E** El filtro se encuentra en el habitáculo detrás de la guantera

CK 200

216 x 200 x 30



O/E numbers

Alfa Romeo 77363481 / 52408346

Cross References

Fram CF10200	Mann CU2232
Micronair MP200	Purflux AH250
Tecnocar E446	Fiaam PC8174

CK 200-C

216 x 200 x 30

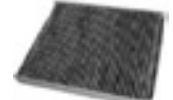

O/E numbers

Alfa Romeo 77363370 / 52407563

Cross References



Fram CFA10199	Mann CUK2232
Micronair MC700	Purflux AHC250
Tecnocar EC446	Fiaam PCK8175





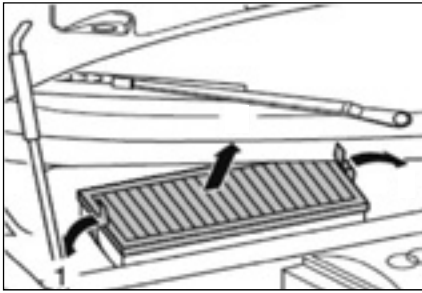

Anti-pollen

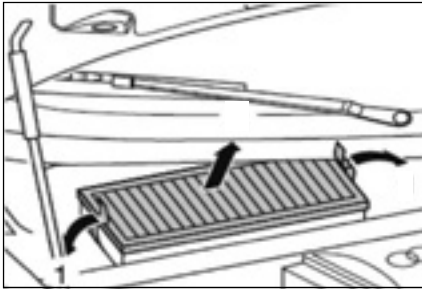

Activated carbon

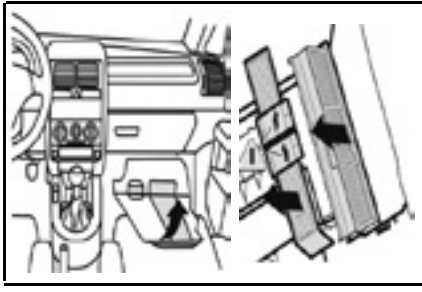

AUDI

<p>--- 80 ---</p>  <p> ① Il filtro è posizionato nel vano motore sul lato passeggero ② The filter is located in the engine compartment on the passenger's side ③ Le filtre est situé dans le compartiment moteur du côté passager ④ Der filter befindet sich Motorraum auf der Beifahrerseite ⑤ El filtro se encuentra en el compartimiento del motor, del lado del acompañante </p>	<p>08/91 -> 12/94</p> <p style="text-align: center;">* * □ □</p>	<p>CK 5662</p> <p>387/377 x 151/141 x 26</p>  <p><u>O/E numbers</u> V.A.G. 8A819439 / 893091700</p> <p><u>Cross References</u> Fram CF5662 Mann CU3955 Micronair MP011 Purflux AH119 Tecocar E313 Fiaam PC8004</p>	<p>CK 5662-C</p> <p>387/377 x 151/141 x 26</p>  <p><u>O/E numbers</u> V.A.G. 3B0091800 / 8D0091800</p> <p><u>Cross References</u> Fram CFA8882 Mann CUK3955 Micronair MC511 Purflux AHC119 Tecocar..... Fiaam PCK8071</p>
--	---	--	--

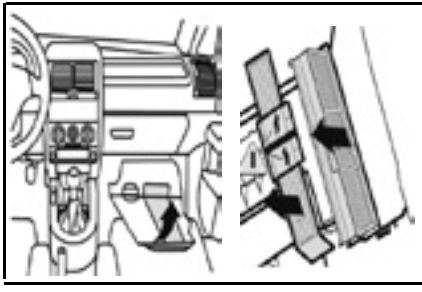
<p>--- 90 / Coupé ---</p>  <p> ① Il filtro è posizionato nel vano motore sul lato passeggero ② The filter is located in the engine compartment on the passenger's side ③ Le filtre est situé dans le compartiment moteur du côté passager ④ Der filter befindet sich Motorraum auf der Beifahrerseite ⑤ El filtro se encuentra en el compartimiento del motor, del lado del acompañante </p>	<p>06/93 -> 12/94</p> <p style="text-align: center;">* * □ □</p>	<p>CK 5662</p> <p>387/377 x 151/141 x 26</p>  <p><u>O/E numbers</u> V.A.G. 8A819439 / 893091700</p> <p><u>Cross References</u> Fram CF5662 Mann CU3955 Micronair MP011 Purflux AH119 Tecocar E313 Fiaam PC8004</p>	<p>CK 5662-C</p> <p>387/377 x 151/141 x 26</p>  <p><u>O/E numbers</u> V.A.G. 3B0091800 / 8D0091800</p> <p><u>Cross References</u> Fram CFA8882 Mann CUK3955 Micronair MC511 Purflux AHC119 Tecocar..... Fiaam PCK8071</p>
--	---	--	--

<p>--- A1 ---</p>  <p> ① Il filtro è posizionato nell'abitacolo dietro il vano portaoggetti ② The filter is located in the passenger compartment behind the glove compartment ③ Le filtre est situé dans l'habitacle derrière la boîte à gants ④ Der filter befindet sich im Fahrgastraum hinter dem Handschuhfach ⑤ El filtro se encuentra en el habitáculo detrás de la guantera </p>	<p>08/10 -></p> <p style="text-align: center;">* * □ □</p>	<p>CK 26010</p> <p>252,5 x 223 x 36</p>  <p><u>O/E numbers</u> V.A.G. 6R0820367</p> <p><u>Cross References</u> Fram CF9323 Mann CU26010 Micronair MP400 Purflux AH191 Tecocar E394 Fiaam</p>	<p>CK 26010-C</p> <p>252,5 x 223 x 36</p>  <p><u>O/E numbers</u> V.A.G. 6R0819653</p> <p><u>Cross References</u> Fram CFA9404 Mann CUK26010 Micronair MC900 Purflux AHC191 Tecocar EC394 Fiaam PCK8092</p>
---	---	--	---

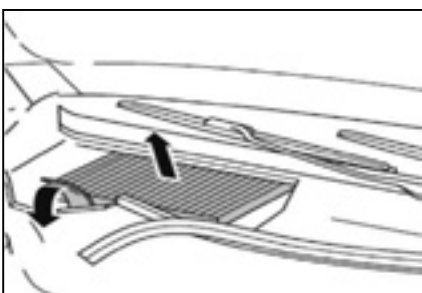
<p>--- A2 ---</p>  <p> ① Il filtro è posizionato nell'abitacolo dietro il vano portaoggetti ② The filter is located in the passenger compartment behind the glove compartment ③ Le filtre est situé dans l'habitacle derrière la boîte à gants ④ Der filter befindet sich im Fahrgastraum hinter dem Handschuhfach ⑤ El filtro se encuentra en el habitáculo detrás de la guantera </p>	<p>05/00 -> 09/05</p> <p style="text-align: center;">* * □ □</p>	<p>CK 9323</p> <p>251 x 216 x 32</p>  <p><u>O/E numbers</u> V.A.G. 6Q0820367</p> <p><u>Cross References</u> Fram CF9323 Mann CU2545 Micronair MP060 Purflux AH191 Tecocar E394 Fiaam PC8077</p>	<p>CK 9323-C</p> <p>251 x 216 x 32</p>  <p><u>O/E numbers</u> V.A.G. 6Q0819653 / 6Q0820367-S</p> <p><u>Cross References</u> Fram CFA9404 Mann CUK2545 Micronair MC560 Purflux AHC191 Tecocar EC394 Fiaam PCK8092</p>
---	---	---	---



<p>--- A3 --- -> Chassis 8LV090450</p>  <p> ① Il filtro è posizionato nel vano motore sul lato passeggero ② The filter is located in the engine compartment on the passenger's side ③ Le filtre est situé dans le compartiment moteur du côté passager ④ Der filter befindet sich Motorraum auf der Beifahrerseite ⑤ El filtro se encuentra en el compartimiento del motor, del lado del acompañante </p>	<p>09/96 -> 04/97</p> <p style="text-align: center;">* * □ □</p>	<p>CK 5663</p> <p>280 x 206 x 25</p>  <p><u>O/E numbers</u> V.A.G. 1H0819644A / 1H0819638A</p> <p><u>Cross References</u> Fram CF5663 Mann CU2882 Micronair MP044 Purflux AH104 Tecocar E311 Fiaam PC8005</p>	<p>CK 5663-C</p> <p>280 x 206 x 25</p>  <p><u>O/E numbers</u> V.A.G. 1H0091800 / 8L0091800</p> <p><u>Cross References</u> Fram CFA8893 Mann CUK2882 Micronair MC544 Purflux AHC104 Tecocar..... Fiaam PCK8072</p>
--	---	---	--





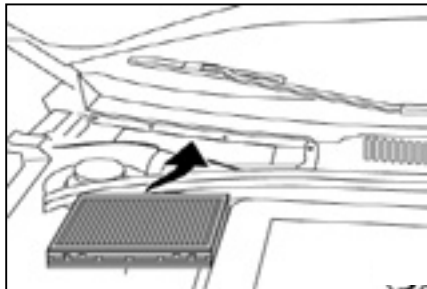

Anti-pollen

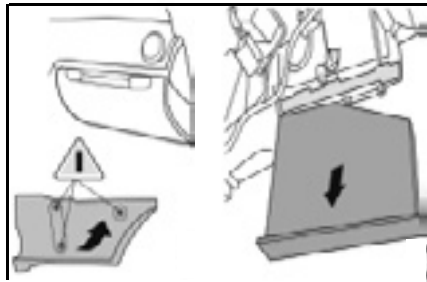

Activated carbon

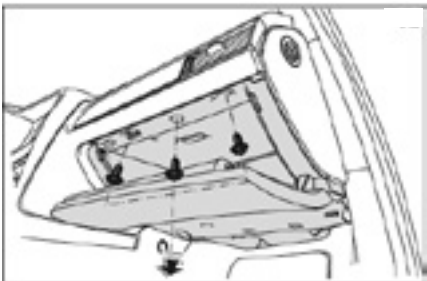

AUDI

<p>--- A3 --- Chassis 8LV090451 -></p> 	<p>05/97 -> 05/03</p> <p>* *</p>	<p>Il filtro è posizionato nel vano motore sul lato passeggero</p> <p>The filter is located in the engine compartment on the passenger's side</p> <p>Le filtre est situé dans le compartiment moteur du côté passager</p> <p>Der filter befindet sich Motorraum auf der Beifahrerseite</p> <p>El filtro se encuentra en el compartimiento del motor, del lado del acompañante</p>	<p>CK 8869-C</p> <p>282 x 206 x 29</p>  <p><u>O/E numbers</u> V.A.G 1J0819644 / 1J0819644A</p> <p><u>Cross References</u> Fram CFA8869 Mann CUK2862 Micronair MC592 Purflux AHC178 Tecocar EC381 Fiaam PCK8045</p>
--	-------------------------------------	---	---

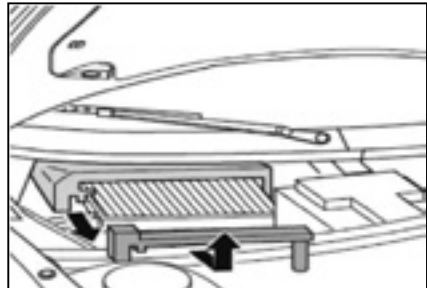
<p>--- A3 + CABRIOLET (8P) ---</p> 	<p>05/03 -></p> <p>* </p>	<p>Il filtro è posizionato nell'abitacolo sotto il vano portaoggetti</p> <p>The filter is located in the passenger compartment under the glove compartment</p> <p>Le filtre est situé dans l'habitacle en dessous de la boîte à gants</p> <p>Der filter befindet sich im Fahrgastraum unter dem Handschuhfach</p> <p>El filtro se encuentra en el habitáculo, bajo la guanterain de pasajerruimte</p>	<p>CK 9922</p> <p>286/280 x 214 x 34/57</p>  <p><u>O/E numbers</u> V.A.G. 1K0819644 / 1K0819644A</p> <p><u>Cross References</u> Fram CF9922 Mann CU2939 Micronair MP113 Purflux AH202 Tecocar E409 Fiaam PC8155</p>	<p>CK 9922-C</p> <p>286/280 x 214 x 34/57</p>  <p><u>O/E numbers</u> V.A.G. 1K1819653 / 1K1819653A</p> <p><u>Cross References</u> Fram CFA9921 Mann CUK2939 Micronair MC613 Purflux AHC202 Tecocar EC409 Fiaam PCK8155</p>
---	------------------------------	---	---	---

<p>--- A3 + CABRIOLET (8VA/8VS/8V7) ---</p> 	<p>04/12 -></p> <p>* </p>	<p>Il filtro è posizionato nell'abitacolo sotto il vano portaoggetti</p> <p>The filter is located in the passenger compartment under the glove compartment</p> <p>Le filtre est situé dans l'habitacle en dessous de la boîte à gants</p> <p>Der filter befindet sich im Fahrgastraum unter dem Handschuhfach</p> <p>El filtro se encuentra en el habitáculo, bajo la guanterain de pasajerruimte</p>	<p>CK 26009</p> <p>253 x 234 x 30</p>  <p><u>O/E numbers</u> V.A.G. 5Q0819644 / 5Q0819644A</p> <p><u>Cross References</u> Fram Mann CU26009 Micronair MP437 Purflux Tecocar Fiaam</p>	<p>CK 26009-C</p> <p>253 x 234 x 30</p>  <p><u>O/E numbers</u> V.A.G. 5Q0819653</p> <p><u>Cross References</u> Fram CFA11643 Mann CUK26009 Micronair MC937 Purflux AHC392 Tecocar EC683 Fiaam PCK8361</p>
--	------------------------------	---	---	--

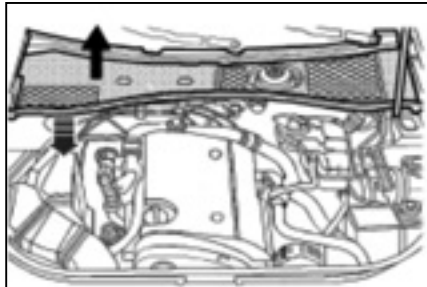
<p>--- A4 (8D, B5) ---</p> 	<p>11/94 -> 09/01</p> <p>* *</p>	<p>Il filtro è posizionato nel vano motore sul lato passeggero</p> <p>The filter is located in the engine compartment on the passenger's side</p> <p>Le filtre est situé dans le compartiment moteur du côté passager</p> <p>Der filter befindet sich Motorraum auf der Beifahrerseite</p> <p>El filtro se encuentra en el compartimiento del motor, del lado del acompañante</p>	<p>CK 5662</p> <p>387 x 151 x 26</p>  <p><u>O/E numbers</u> V.A.G. 8A819439 / 893091700</p> <p><u>Cross References</u> Fram CF5662 Mann CU3955 Micronair MP011 Purflux AH119 Tecocar E313 Fiaam PC8004</p>	<p>CK 5662-C</p> <p>387 x 151 x 26</p>  <p><u>O/E numbers</u> V.A.G. 3B0091800 / 8D0091800</p> <p><u>Cross References</u> Fram CFA8882 Mann CUK3955 Micronair MC511 Purflux AHC119 Tecocar..... Fiaam PCK8071</p>
---	-------------------------------------	---	--	--

<p>--- A4 (8E/8H, B6/B7) ---</p> 	<p>11/00 -> 12/08</p> <p>* *</p>	<p>Il filtro è posizionato nel vano motore sul lato passeggero</p> <p>The filter is located in the engine compartment on the passenger's side</p> <p>Le filtre est situé dans le compartiment moteur du côté passager</p> <p>Der filter befindet sich Motorraum auf der Beifahrerseite</p> <p>El filtro se encuentra en el compartimiento del motor, del lado del acompañante</p>	<p>CK 9645</p> <p>300 x 204,5 x 30</p>  <p><u>O/E numbers</u> V.A.G. 8E0819439</p> <p><u>Cross References</u> Fram CF9645 Mann CU3037 Micronair MP106 Purflux AH184 Tecocar E387 Fiaam PC8117</p>	<p>CK 9645-C</p> <p>300 x 204,5 x 30</p>  <p><u>O/E numbers</u> V.A.G. 4B0819439C</p> <p><u>Cross References</u> Fram CFA9548 Mann CUK3037 Micronair MC606 Purflux AHC184 Tecocar EC387 Fiaam PCK8103</p>
---	-------------------------------------	---	---	--



Anti-pollen

Activated carbon

AUDI

--- A4 (8K, B8) ---

11/07 ->

*



- I** Il filtro è posizionato nell'abitacolo dietro il vano portaoggetti
- GB** The filter is located in the passenger compartment behind the glove compartment
- F** Le filtre est situé dans l'habitacle derrière la boîte à gants
- D** Der filter befindet sich im Fahrgastraum hinter dem Handschuhfach
- E** El filtro se encuentra en el habitáculo detrás de la guantera

CK 10457

238 x 280/189 x 35



O/E numbers

Audi 8K0819439

Cross References

Fram CF10457 Mann CU2450
 Micronair MP271 Purflux AH269
 Tecocar E478 Fiaam PC8209

CK 10457-C

238 x 280/189 x 35



O/E numbers

Audi 8K0819439A

Cross References

Fram CFA10458 Mann CUK2450
 Micronair MC771 Purflux AHC269
 Tecocar EC478 Fiaam PCK8120

--- A5 (8T, 8F) ---

10/07 ->

*



- I** Il filtro è posizionato nell'abitacolo dietro il vano portaoggetti
- GB** The filter is located in the passenger compartment behind the glove compartment
- F** Le filtre est situé dans l'habitacle derrière la boîte à gants
- D** Der filter befindet sich im Fahrgastraum hinter dem Handschuhfach
- E** El filtro se encuentra en el habitáculo detrás de la guantera

CK 10457

238 x 280/189 x 35



O/E numbers

Audi 8K0819439

Cross References

Fram CF10457 Mann CU2450
 Micronair MP271 Purflux AH269
 Tecocar E478 Fiaam PC8209

CK 10457-C

238 x 280/189 x 35



O/E numbers

Audi 8K0819439A

Cross References

Fram CFA10458 Mann CUK2450
 Micronair MC771 Purflux AHC269
 Tecocar EC478 Fiaam PCK8120

--- A6 (4A/C4) ---

06/94 -> 07/97

*

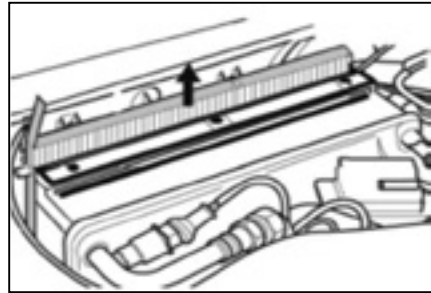

- I** Il filtro è posizionato nel vano motore sul lato passeggero sotto il coperchio della vaschetta del radiatore
- GB** The filter is located in the engine compartment on the passenger's side under the radiator tank cover
- F** Le filtre est situé dans le compartiment moteur du côté passager en dessous du cache du réservoir à eau
- D** Der filter befindet sich Motorraum auf der Beifahrerseite unter der Wasserkastenabdeckung
- E** El filtro se encuentra en el compartimiento del motor, lado del acompañante, bajo la cubierta del depósito del agua

CK 5824

345 x 214 x 20



O/E numbers

V.A.G. 4A1820367

Cross References

Fram CF5824 Mann CU3562
 Micronair MP048 Purflux AH139
 Tecocar E347 Fiaam PC8009

CK 5824-C

345 x 214 x 20

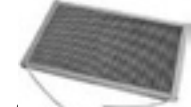

O/E numbers

V.A.G. 4A0091800

Cross References

Fram..... Mann.....
 Micronair MC548 Purflux.....
 Tecocar..... Fiaam.....

--- A6 (4A/C4) ---

06/94 -> 07/97

*

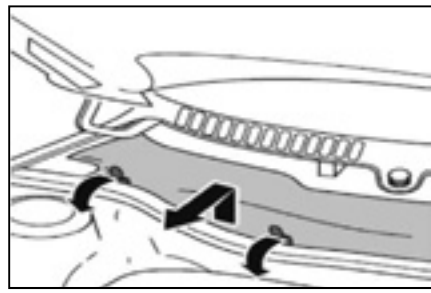

- I** Il filtro è posizionato nel vano motore sul lato passeggero sotto il coperchio della vaschetta del radiatore
- GB** The filter is located in the engine compartment on the passenger's side under the radiator tank cover
- F** Le filtre est situé dans le compartiment moteur du côté passager en dessous du cache du réservoir à eau
- D** Der filter befindet sich Motorraum auf der Beifahrerseite unter der Wasserkastenabdeckung
- E** El filtro se encuentra en el compartimiento del motor, lado del acompañante, bajo la cubierta del depósito del agua

CK 5942

308 x 194 x 29



O/E numbers

V.A.G. 4A0819439A

Cross References

Fram CF5942 Mann CU3192
 Micronair MP049 Purflux AH147
 Tecocar E353 Fiaam PC8032

CK 5942-C

308 x 194 x 29



O/E numbers

V.A.G. 4A0091800 / 4B0819439

Cross References

Fram CFA8876 Mann CUK3192
 Micronair MC549 Purflux AHC147
 Tecocar EC353 Fiaam PCK8062

--- A6 (4B/C5) ---

-> Chassis 4BX045000

01/97 -> 07/05

*

*

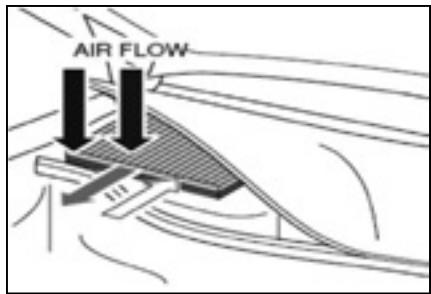

- I** Il filtro è posizionato nel vano motore sul lato passeggero sotto il coperchio della vaschetta del radiatore
- GB** The filter is located in the engine compartment on the passenger's side under the radiator tank cover
- F** Le filtre est situé dans le compartiment moteur du côté passager en dessous du cache du réservoir à eau
- D** Der filter befindet sich Motorraum auf der Beifahrerseite unter der Wasserkastenabdeckung
- E** El filtro se encuentra en el compartimiento del motor, lado del acompañante, bajo la cubierta del depósito del agua

CK 5942

308 x 194 x 29



O/E numbers

V.A.G. 4A0819439A

Cross References

Fram CF5942 Mann CU3192
 Micronair MP049 Purflux AH147
 Tecocar E353 Fiaam PC8032

CK 5942-C

308 x 194 x 29



O/E numbers

V.A.G. 4A0091800 / 4B0819439

Cross References

Fram CFA8876 Mann CUK3192
 Micronair MC549 Purflux AHC147
 Tecocar EC353 Fiaam PCK8062



Anno di fabbricazione / Year of construction
 Anné de fabrication / Baujahr / Año de fabricación



Con climatizzatore / With air-conditioning / Avec climatisation
 Mit Klimaanlage / Con instalación de aire acondicionado





Senza climatizzatore / Without air-conditioning / Sans climatisation
 Ohne Klimaanlage / Sin instalación de aire acondicionado





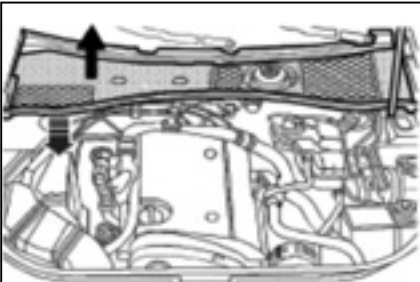

Anti-pollen

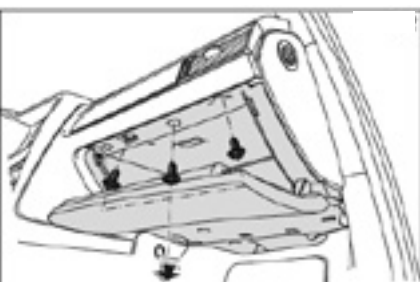
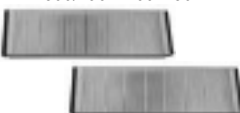

Activated carbon

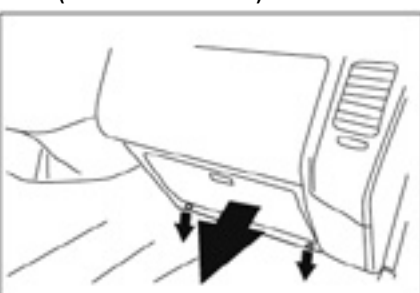

AUDI

<p>--- A6 (4B/C5) --- Chassis 4BX045001 -></p>  <p> I Il filtro è posizionato nel vano motore sul lato passeggero sotto il coperchio della vaschetta del radiatore GB The filter is located in the engine compartment on the passenger's side under the radiator tank cover F Le filtre est situé dans le compartiment moteur du côté passager en dessous du cache du réservoir à eau D Der filter befindet sich Motorraum auf der Beifahrerseite unter der Wasserkastenabdeckung E El filtro se encuentra en el compartimiento del motor, lado del acompañante, bajo la cubierta del depósito del agua </p>	<p>01/97 -> 07/05</p> <p style="text-align: center;">* * □ □</p>	<p>CK 9645 300 x 204,5 x 30</p>  <p><u>O/E numbers</u> V.A.G. 8E0819439 <u>Cross References</u> Fram CF9645 Mann CU3037 Micronair MP106 Purflux AH184 Tecocar E387 Fiaam PC8117</p>	<p>CK 9645-C 300 x 204,5 x 30</p>  <p><u>O/E numbers</u> V.A.G. 4B0819439C <u>Cross References</u> Fram CFA9548 Mann CUK3037 Micronair MC606 Purflux AHC184 Tecocar EC387 Fiaam PCK8103</p>
--	---	--	---

<p>--- A6 (4F/C6) ---</p>  <p> I Il filtro è posizionato nell'abitacolo sotto il vano portaoggetti GB The filter is located in the passenger compartment under the glove compartment F Le filtre est situé dans l'habitacle en dessous de la boîte à gants D Der filter befindet sich im Fahrgastraum unter dem Handschuhfach E El filtro se encuentra en el habitáculo, bajo la guanterain de pasajerruimte </p>	<p>04/04 -> 09/11</p> <p style="text-align: center;">* * □ □</p>	<p>CK 10209-2 306/296 x 100 x 30</p>  <p><u>O/E numbers</u> V.A.G. 4F0819439 / 4F0898438 <u>Cross References</u> Fram..... Mann CU3023-2 Micronair MP185 Puflex..... Tecocar..... Fiaam.....</p>	<p>CK 10209-C-2 306/296 x 100 x 30</p>  <p><u>O/E numbers</u> V.A.G. 4F0819439A / 4F0898438A <u>Cross References</u> Fram CFA10209-2 Mann CUK3023-2 Micronair MC685 Puflex AHC247 Tecocar EC449 Fiaam PCK8171-2</p>
--	---	---	---

<p>--- A6 (4G2/4G5/4GC/4GD) ---</p>  <p> I Il filtro è posizionato nell'abitacolo dietro il vano portaoggetti GB The filter is located in the passenger compartment behind the glove compartment F Le filtre est situé dans l'habitacle derrière la boîte à gants D Der filter befindet sich im Fahrgastraum hinter dem Handschuhfach E El filtro se encuentra en el habitáculo detrás de la guantera </p>	<p>04/11 -></p> <p style="text-align: center;">* * □ □</p>	<p>---</p>	<p>CK 2641-C 251 x 255/156 x 35,5</p>  <p><u>O/E numbers</u> V.A.G. 4H0819439 <u>Cross References</u> Fram CFA11436 Mann CUK2641 Micronair MC908 Purflux AHC362 Tecocar EC655 Fiaam PCK8332</p>
---	---	------------	---

<p>--- A7 (4GA/GF) ---</p>  <p> I Il filtro è posizionato nell'abitacolo dietro il vano portaoggetti GB The filter is located in the passenger compartment behind the glove compartment F Le filtre est situé dans l'habitacle derrière la boîte à gants D Der filter befindet sich im Fahrgastraum hinter dem Handschuhfach E El filtro se encuentra en el habitáculo detrás de la guantera </p>	<p>10/10 -></p> <p style="text-align: center;">* * □ □</p>	<p>---</p>	<p>CK 2641-C 251 x 255/156 x 35,5</p>  <p><u>O/E numbers</u> V.A.G. 4H0819439 <u>Cross References</u> Fram CFA11436 Mann CUK2641 Micronair MC908 Purflux AHC362 Tecocar EC655 Fiaam PCK8332</p>
--	---	------------	---









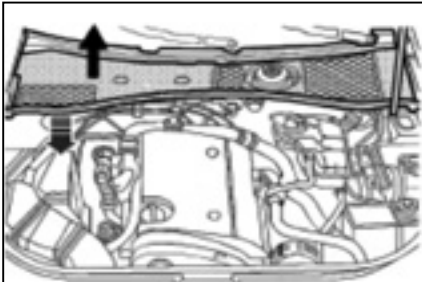

<p>--- A8 (4H) ---</p>  <p> I Il filtro è posizionato nell'abitacolo dietro il vano portaoggetti GB The filter is located in the passenger compartment behind the glove compartment F Le filtre est situé dans l'habitacle derrière la boîte à gants D Der filter befindet sich im Fahrgastraum hinter dem Handschuhfach E El filtro se encuentra en el habitáculo detrás de la guantera </p>	<p>03/10 -></p> <p style="text-align: center;">* □ □ □</p>	<p>---</p>	<p>CK 2641-C 251 x 255/156 x 35,5</p>  <p><u>O/E numbers</u> V.A.G. 4H0819439 <u>Cross References</u> Fram CFA11436 Mann CUK2641 Micronair MC908 Purflux AHC362 Tecocar EC655 Fiaam PCK8332</p>
--	---	------------	---

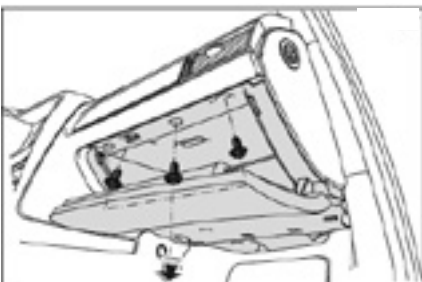
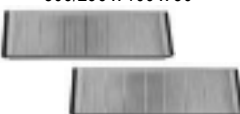

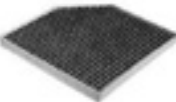
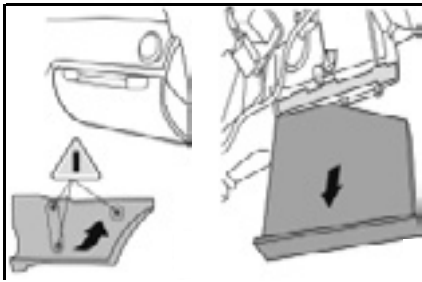
Anti-pollen

Activated carbon

AUDI



<p>--- Allroad I (4BH) ---</p>  <p> ① Il filtro è posizionato nel vano motore sul lato passeggero sotto il coperchio della vaschetta del radiatore ② The filter is located in the engine compartment on the passenger's side under the radiator tank cover ③ Le filtre est situé dans le compartiment moteur du côté passager en dessous du cache du réservoir à eau ④ Der filter befindet sich Motorraum auf der Beifahrerseite unter der Wasserkastenabdeckung ⑤ El filtro se encuentra en el compartimiento del motor, lado del acompañante, bajo la cubierta del depósito del agua </p>	<p>05/00 -> 08/05</p> <p>* *</p>	<p>CK 9645</p> <p>300 x 204,5 x 30</p>  <p><u>O/E numbers</u> V.A.G. 8E0819439</p> <p><u>Cross References</u> Fram CF9645 Mann CU3037 Micronair MP106 Purflux AH184 Tecocar E387 Fiaam PC8117</p>	<p>CK 9645-C</p> <p>300 x 204,5 x 30</p>  <p><u>O/E numbers</u> V.A.G. 4B0819439C</p> <p><u>Cross References</u> Fram CFA9548 Mann CUK3037 Micronair MC606 Purflux AHC184 Tecocar EC387 Fiaam PCK8103</p>
<p>--- Allroad II (4FH) ---</p>  <p> ① Il filtro è posizionato nell'abitacolo sotto il vano portaoggetti ② The filter is located in the passenger compartment under the glove compartment ③ Le filtre est situé dans l'habitacle en dessous de la boîte à gants ④ Der filter befindet sich im Fahrgastraum unter dem Handsuhfach ⑤ El filtro se encuentra en el habitáculo, bajo la guantera de pasajerruimte </p>	<p>05/06 -> 09/11</p> <p>* *</p>	<p>CK 10209-2</p> <p>306/296 x 100 x 30</p>  <p><u>O/E numbers</u> V.A.G. 4F0819439 / 4F0898438</p> <p><u>Cross References</u> Fram..... Mann CU3023 Micronair MP185 Puflex..... Tecocar..... Fiaam.....</p>	<p>CK 10209-C-2</p> <p>306/296 x 100 x 30</p>  <p><u>O/E numbers</u> V.A.G. 4F0819439A / 4F0898438A</p> <p><u>Cross References</u> Fram CFA10209-2 Mann CUK3023 Micronair MC685 Puflex AHC247 Tecocar EC449 Fiaam PCK8171-2</p>
<p>--- Allroad III (4GH) ---</p>  <p> ① Il filtro è posizionato nell'abitacolo dietro il vano portaoggetti ② The filter is located in the passenger compartment behind the glove compartment ③ Le filtre est situé dans l'habitacle derrière la boîte à gants ④ Der filter befindet sich im Fahrgastraum hinter dem Handsuhfach ⑤ El filtro se encuentra en el habitáculo detrás de la guantera </p>	<p>01/12 -></p> <p>* *</p>	<p>---</p>	<p>CK 2641-C</p> <p>251 x 255/156 x 35,5</p>  <p><u>O/E numbers</u> V.A.G. 4H0819439</p> <p><u>Cross References</u> Fram CFA11436 Mann CUK2641 Micronair MC908 Purflux AHC362 Tecocar EC655 Fiaam PCK8332</p>
<p>--- Q3 (8U) ---</p>  <p> ① Il filtro è posizionato nell'abitacolo sotto il vano portaoggetti ② The filter is located in the passenger compartment under the glove compartment ③ Le filtre est situé dans l'habitacle en dessous de la boîte à gants ④ Der filter befindet sich im Fahrgastraum unter dem Handsuhfach ⑤ El filtro se encuentra en el habitáculo, bajo la guantera de pasajerruimte </p>	<p>09/11 -></p> <p>* </p>	<p>CK 9922</p> <p>286/280 x 214 x 34/57</p>  <p><u>O/E numbers</u> V.A.G. 1K0819644 / 1K0819644A</p> <p><u>Cross References</u> Fram CF9922 Mann CU2939 Micronair MP113 Purflux AH202 Tecocar E409 Fiaam PC8155</p>	<p>CK 9922-C</p> <p>286/280 x 214 x 34/57</p>  <p><u>O/E numbers</u> V.A.G. 1K1819653 / 1K1819653A</p> <p><u>Cross References</u> Fram CFA9921 Mann CUK2939 Micronair MC613 Purflux AHC202 Tecocar EC409 Fiaam PCK8155</p>
<p>--- Q5 (8R) ---</p>  <p> ① Il filtro è posizionato nell'abitacolo dietro il vano portaoggetti ② The filter is located in the passenger compartment behind the glove compartment ③ Le filtre est situé dans l'habitacle derrière la boîte à gants ④ Der filter befindet sich im Fahrgastraum hinter dem Handsuhfach ⑤ El filtro se encuentra en el habitáculo detrás de la guantera </p>	<p>11/08 -></p> <p>* </p>	<p>CK 10457</p> <p>238 x 280/189 x 35</p>  <p><u>O/E numbers</u> Audi 8K0819439</p> <p><u>Cross References</u> Fram CF10457 Mann CU2450 Micronair MP271 Purflux AH269 Tecocar E478 Fiaam PC8209</p>	<p>CK 10457-C</p> <p>238 x 280/189 x 35</p>  <p><u>O/E numbers</u> Audi 8K0819439A</p> <p><u>Cross References</u> Fram CFA10458 Mann CUK2450 Micronair MC771 Purflux AHC269 Tecocar EC478 Fiaam PCK8120</p>





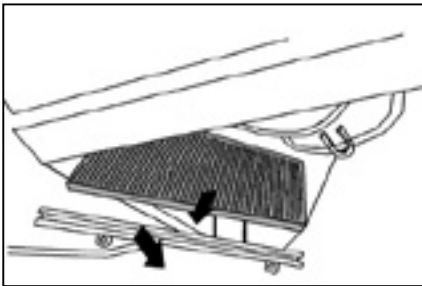

Anti-pollen

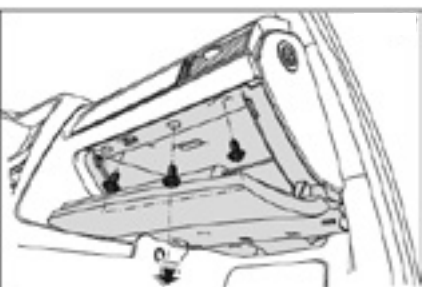

Activated carbon

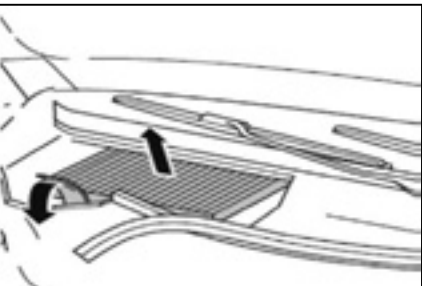

AUDI

<p>--- Q7 (4L) ---</p> 	03/06 ->	*		<p>CK 9881 227 x 218 x 31</p>  <p><u>O/E numbers</u> V.A.G. 7H0819631</p> <p><u>Cross References</u> Fram CF9881 Mann CU2842 Micronair MP141 Purflux AH209 Tecocar E413 Fiaam PC8158</p>	<p>CK 9881-C 227 x 218 x 31</p>  <p><u>O/E numbers</u> V.A.G. 7H0819631A</p> <p><u>Cross References</u> Fram CFA9881 Mann CUK2842 Micronair MC641 Purflux AHC209 Tecocar EC413 Fiaam PCK8158</p>
	<p>I Il filtro è posizionato nell'abitacolo sotto il vano portaoggetti</p> <p>GB The filter is located in the passenger compartment under the glove compartment</p> <p>F Le filtre est situé dans l'habitacle en dessous de la boîte à gants</p> <p>D Der filter befindet sich im Fahrgastraum unter dem Handsuhfach</p> <p>E El filtro se encuentra en el habitáculo, bajo la guantera de pasajerruimte</p>				

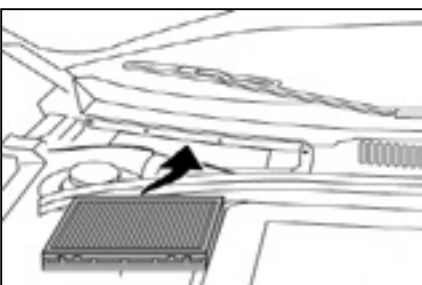
<p>--- R8 (42) ---</p> 	03/07 -> 07/15	*	*	<p>CK 10209-2 306/296 x 100 x 30</p>  <p><u>O/E numbers</u> V.A.G. 4F0819439 / 4F0898438</p> <p><u>Cross References</u> Fram..... Mann CU3023 Micronair MP185 Puflex..... Tecocar..... Fiaam.....</p>	<p>CK 10209-C-2 306/296 x 100 x 30</p>  <p><u>O/E numbers</u> V.A.G. 4F0819439A / 4F0898438A</p> <p><u>Cross References</u> Fram CFA10209-2 Mann CUK3023 Micronair MC685 Puflex AHC247 Tecocar EC449 Fiaam PCK8171-2</p>
	<p>I Il filtro è posizionato nell'abitacolo sotto il vano portaoggetti</p> <p>GB The filter is located in the passenger compartment under the glove compartment</p> <p>F Le filtre est situé dans l'habitacle en dessous de la boîte à gants</p> <p>D Der filter befindet sich im Fahrgastraum unter dem Handsuhfach</p> <p>E El filtro se encuentra en el habitáculo, bajo la guantera de pasajerruimte</p>				

<p>--- TT (8N) --- -> Chassis 8N1014000</p> 	09/98 -> 08/00	*	*	<p>CK 5663 280 x 206 x 25</p>  <p><u>O/E numbers</u> V.A.G. 1H0819644A / 1H0819638A</p> <p><u>Cross References</u> Fram CF5663 Mann CU2882 Micronair MP044 Purflux AH104 Tecocar E311 Fiaam PC8005</p>	<p>CK 5663-C 280 x 206 x 25</p>  <p><u>O/E numbers</u> V.A.G. 1H0091800 / 8L0091800</p> <p><u>Cross References</u> Fram CFA8893 Mann CUK2882 Micronair MC544 Purflux AHC104 Tecocar..... Fiaam PCK8072</p>
	<p>I Il filtro è posizionato nel vano motore sul lato passeggero</p> <p>GB The filter is located in the engine compartment on the passenger's side</p> <p>F Le filtre est situé dans le compartiment moteur du côté passager</p> <p>D Der filter befindet sich Motorraum auf der Beifahrerseite</p> <p>E El filtro se encuentra en el compartimiento del motor, del lado del acompañante</p>				

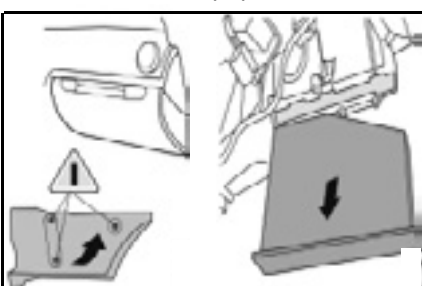
<p>--- TT (8N) --- Chassis 8N1014001 -></p> 	09/00 -> 08/06	*	*	<p>---</p>	<p>CK 8869-C 282 x 206 x 29</p>  <p><u>O/E numbers</u> V.A.G. 1J0819644 / 1J0819644A</p> <p><u>Cross References</u> Fram CFA8869 Mann CUK2862 Micronair MC592 Purflux AHC178 Tecocar EC381 Fiaam PCK8045</p>
	<p>I Il filtro è posizionato nel vano motore sul lato passeggero</p> <p>GB The filter is located in the engine compartment on the passenger's side</p> <p>F Le filtre est situé dans le compartiment moteur du côté passager</p> <p>D Der filter befindet sich Motorraum auf der Beifahrerseite</p> <p>E El filtro se encuentra en el compartimiento del motor, del lado del acompañante</p>				

<p>--- TT / TTS / TTRS II (8J) ---</p> 	09/06 ->	*		<p>CK 9922 286/280 x 214 x 34/57</p>  <p><u>O/E numbers</u> V.A.G. 1K0819644 / 1K0819644A</p> <p><u>Cross References</u> Fram CF9922 Mann CU2939 Micronair MP113 Purflux AH202 Tecocar E409 Fiaam PC8155</p>	<p>CK 9922-C 286/280 x 214 x 34/57</p>  <p><u>O/E numbers</u> V.A.G. 1K1819653 / 1K1819653A</p> <p><u>Cross References</u> Fram CFA9921 Mann CUK2939 Micronair MC613 Purflux AHC202 Tecocar EC409 Fiaam PCK8155</p>
	<p>I Il filtro è posizionato nell'abitacolo sotto il vano portaoggetti</p> <p>GB The filter is located in the passenger compartment under the glove compartment</p> <p>F Le filtre est situé dans l'habitacle en dessous de la boîte à gants</p> <p>D Der filter befindet sich im Fahrgastraum unter dem Handsuhfach</p> <p>E El filtro se encuentra en el habitáculo, bajo la guantera de pasajerruimte</p>				



Anti-pollen

Activated carbon

AUDI

--- TT / TTS (FV) ---

07/14 ->

*

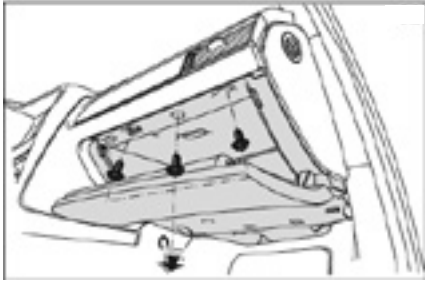

- Il filtro è posizionato nell'abitacolo sotto il vano portaoggetti
- The filter is located in the passenger compartment under the glove compartment
- Le filtre est situé dans l'habitacle en dessous de la boîte à gants
- Der filter befindet sich im Fahrgastraum unter dem Handshuhfach
- El filtro se encuentra en el habitáculo, bajo la guantera de pasajerruimte

CK 26009

253 x 234 x 30



O/E numbers

V.A.G. 5Q0819644 / 5Q0819644A

Cross References

Fram Mann CU26009
 Micronair MP437 Purflux
 Tecnocar Fiaam

CK 26009-C

253 x 234 x 30



O/E numbers

V.A.G. 5Q0819653

Cross References

Fram CFA11643 Mann CUK26009
 Micronair MC937 Purflux AHC392
 Tecnocar EC683 Fiaam PCK8361

--	--	--

--	--	--

--	--	--

--	--	--



Anti-pollen

Activated carbon

BMW

--- SERIE 1 (E81/E82/E87/E88) ---

09/04 ->

*

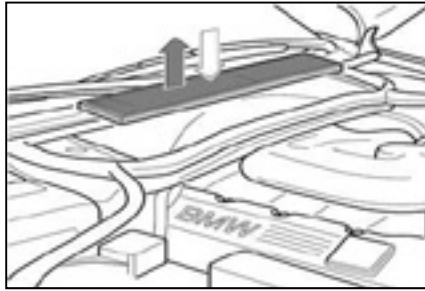

- I** Il filtro è posizionato nel vano motore al centro
- GB** The filter is located in the engine compartment centrally
- F** Le filtre est situé dans le compartiment moteur au centre
- D** Der Filter befindet sich im Motorraum mittig
- E** El filtro se encuentra en el compartimiento del motor, en el centro

CK 8430

834 x 134 x 26



O/E numbers

Bmw 64316946629 / 64316962548

Cross References

Fram CF10207 Mann CU8430
Micronair MP195 Purflux AH246
TecnoCar..... Fiaam PC8172

CK 8430-C

834 x 134 x 26



O/E numbers

Bmw 64316946628 / 64316962549

Cross References

Fram CFA10206 Mann CUK8430
Micronair MC695 Purflux AHC246
TecnoCar EC448 Fiaam PCK8172

--- SERIE 1 (F20/F21) ---

09/11 ->

*

*

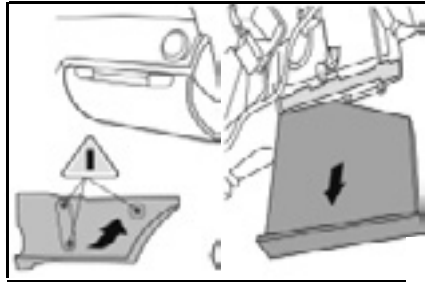

- I** Il filtro è posizionato nell'abitacolo sotto il vano portaoggetti
- GB** The filter is located in the passenger compartment under the glove compartment
- F** Le filtre est situé dans l'habitacle en dessous de la boîte à gants
- D** Der filter befindet sich im Fahrgastraum unter dem Handshuhfach
- E** El filtro se encuentra en el habitáculo, bajo la guantera de pasajerruimte

CK 25001-C

250 x 198 x 41



O/E numbers

Bmw 64119237555

Cross References

Fram CFA11472 Mann CUK25001
Micronair MC930 Purflux AHC373
TecnoCar EC667 Fiaam PCK8342

--- SERIE 2 (F22/F23) ---

02/14 ->

*

*

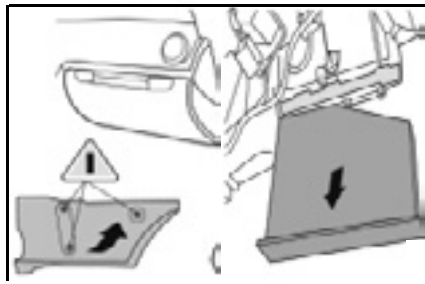

- I** Il filtro è posizionato nell'abitacolo sotto il vano portaoggetti
- GB** The filter is located in the passenger compartment under the glove compartment
- F** Le filtre est situé dans l'habitacle en dessous de la boîte à gants
- D** Der filter befindet sich im Fahrgastraum unter dem Handshuhfach
- E** El filtro se encuentra en el habitáculo, bajo la guantera de pasajerruimte

CK 25001-C

250 x 198 x 41



O/E numbers

Bmw 64119237555

Cross References

Fram CFA11472 Mann CUK25001
Micronair MC930 Purflux AHC373
TecnoCar EC667 Fiaam PCK8342

--- SERIE 2 ACTIVE TOURER (F45/F46) ---

08/14 ->

*

*

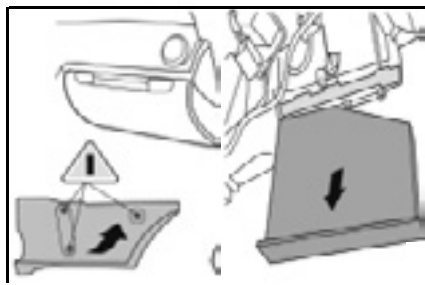

- I** Il filtro è posizionato nell'abitacolo sotto il vano portaoggetti
- GB** The filter is located in the passenger compartment under the glove compartment
- F** Le filtre est situé dans l'habitacle en dessous de la boîte à gants
- D** Der filter befindet sich im Fahrgastraum unter dem Handshuhfach
- E** El filtro se encuentra en el habitáculo, bajo la guantera de pasajerruimte

CK 23005-C-2

232 x 116 x 32



O/E numbers

Bmw 64119321875 / 64319297750

Cross References

Fram CFA11815-2 Mann CUK23005-2
Micronair Purflux AHC428-2
TecnoCar EC722-2 Fiaam PCK8408-2

--- SERIE 3 / M3 (E36) ---

06/90 -> 10/99

*

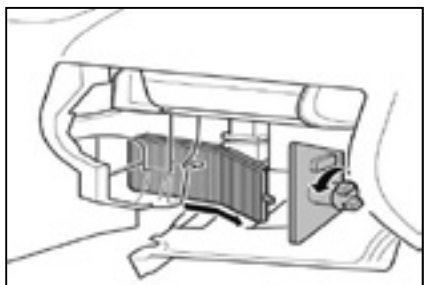

- I** Il filtro è posizionato nell'abitacolo dietro il vano portaoggetti
- GB** The filter is located in the passenger compartment behind the glove compartment
- F** Le filtre est situé dans l'habitacle derrière la boîte à gants
- D** Der filter befindet sich im Fahrgastraum hinter dem Handshuhfach
- E** El filtro se encuentra en el habitáculo detrás de la guantera

CK 8103

290/280 x 168/158 x 26



O/E numbers

Bmw 64111393489 / 64119069895

Cross References



Fram CF8103 Mann CU2835
Micronair MP003 Purflux AH120
TecnoCar E322 Fiaam PC8015







Anti-pollen

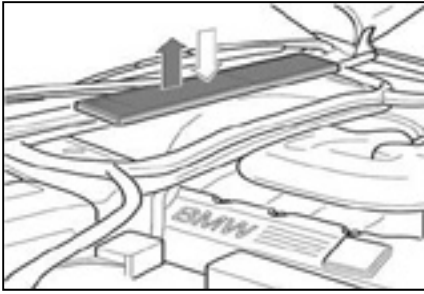

Activated carbon

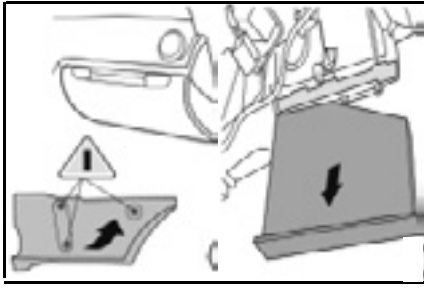

BMW

<p>--- SERIE 3 / M3 (E46) ---</p>  <ul style="list-style-type: none"> I Il filtro è posizionato nel vano motore al centro GB The filter is located in the engine compartment centrally F Le filtre est situé dans le compartiment moteur au centre D Der Filter befindet sich im Motorraum mitting E El filtro se encuentra en el compartimiento del motor, en el centro 	<p>05/98 -> 09/05</p> <p style="text-align: center;">* * --- ---</p>	<p>CK 8913 668 x 103 x 23,6</p>  <p><u>O/E numbers</u> Bmw 64319071934 / 64318361899</p> <p><u>Cross References</u> Fram CF8913 Mann CU6724 Micronair MP038 Purflux AH187 Tecocar..... Fiaam PC8053</p>	<p>CK 8913-C 668 x 103 x 23,6</p>  <p><u>O/E numbers</u> Bmw 64319071935</p> <p><u>Cross References</u> Fram CFA8913 Mann CUK6724 Micronair MC538 Purflux AHC187 Tecocar EC390 Fiaam PCK8053</p>
---	---	---	---

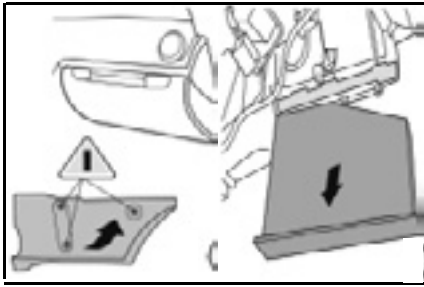
<p>--- SERIE 3 (E90/E91/E92/E93) ---</p>  <ul style="list-style-type: none"> I Il filtro è posizionato nel vano motore al centro GB The filter is located in the engine compartment centrally F Le filtre est situé dans le compartiment moteur au centre D Der Filter befindet sich im Motorraum mitting E El filtro se encuentra en el compartimiento del motor, en el centro 	<p>03/05 -></p> <p style="text-align: center;">* * --- ---</p>	<p>CK 8430 834 x 134 x 26</p>  <p><u>O/E numbers</u> Bmw 64316946629 / 64316962548</p> <p><u>Cross References</u> Fram CF10207 Mann CU8430 Micronair MP195 Purflux AH246 Tecocar..... Fiaam PC8172</p>	<p>CK 8430-C 834 x 134 x 26</p>  <p><u>O/E numbers</u> Bmw 64316946628 / 64316962549</p> <p><u>Cross References</u> Fram CFA10206 Mann CUK8430 Micronair MC695 Purflux AHC246 Tecocar EC448 Fiaam PCK8172</p>
--	---	--	--

<p>--- SERIE 3 (F30/F31/F80) ---</p>  <ul style="list-style-type: none"> I Il filtro è posizionato nell'abitacolo sotto il vano portaoggetti GB The filter is located in the passenger compartment under the glove compartment F Le filtre est situé dans l'habitacle en dessous de la boîte à gants D Der filter befindet sich im Fahrgastraum unter dem Handsuhfach E El filtro se encuentra en el habitáculo, bajo la guantera de pasajerruimte 	<p>10/11 -></p> <p style="text-align: center;">* * --- ---</p>	<p>---</p>	<p>CK 25001-C 250 x 198 x 41</p>  <p><u>O/E numbers</u> Bmw 64119237555</p> <p><u>Cross References</u> Fram CFA11472 Mann CUK25001 Micronair MC930 Purflux AHC373 Tecocar EC667 Fiaam PCK8342</p>
---	---	------------	--

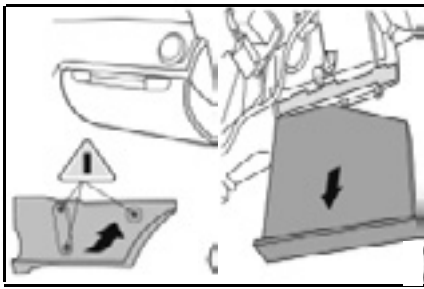
<p>--- SERIE 3 GT (F34) ---</p>  <ul style="list-style-type: none"> I Il filtro è posizionato nell'abitacolo sotto il vano portaoggetti GB The filter is located in the passenger compartment under the glove compartment F Le filtre est situé dans l'habitacle en dessous de la boîte à gants D Der filter befindet sich im Fahrgastraum unter dem Handsuhfach E El filtro se encuentra en el habitáculo, bajo la guantera de pasajerruimte 	<p>05/13 -></p> <p style="text-align: center;">* * --- ---</p>	<p>---</p>	<p>CK 25001-C 250 x 198 x 41</p>  <p><u>O/E numbers</u> Bmw 64119237555</p> <p><u>Cross References</u> Fram CFA11472 Mann CUK25001 Micronair MC930 Purflux AHC373 Tecocar EC667 Fiaam PCK8342</p>
--	---	------------	--



<p>--- SERIE 4 (F32/F33/F36/F82) ---</p>  <ul style="list-style-type: none"> I Il filtro è posizionato nell'abitacolo sotto il vano portaoggetti GB The filter is located in the passenger compartment under the glove compartment F Le filtre est situé dans l'habitacle en dessous de la boîte à gants D Der filter befindet sich im Fahrgastraum unter dem Handsuhfach E El filtro se encuentra en el habitáculo, bajo la guantera de pasajerruimte 	<p>07/13 -></p> <p style="text-align: center;">* * --- ---</p>	<p>---</p>	<p>CK 25001-C 250 x 198 x 41</p>  <p><u>O/E numbers</u> Bmw 64119237555</p> <p><u>Cross References</u> Fram CFA11472 Mann CUK25001 Micronair MC930 Purflux AHC373 Tecocar EC667 Fiaam PCK8342</p>
---	---	------------	--



Anti-pollen

Activated carbon

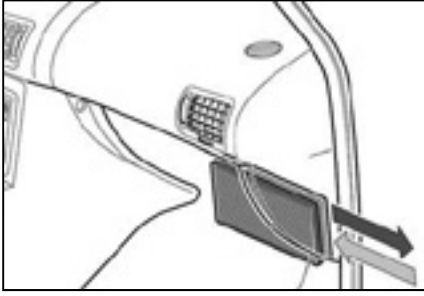
BMW

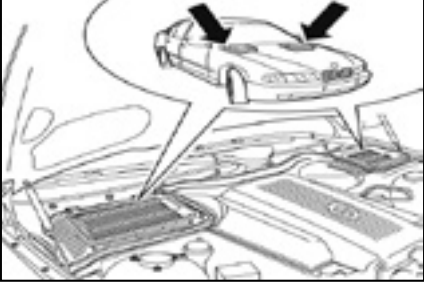
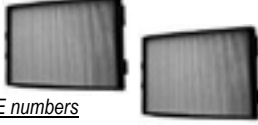
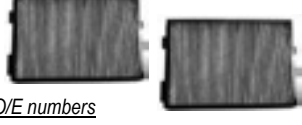
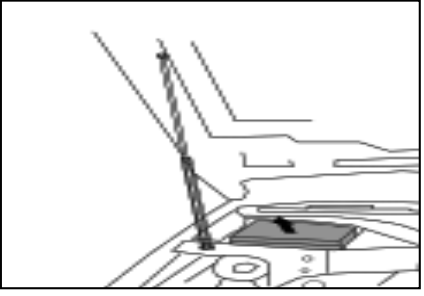
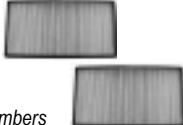
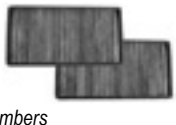
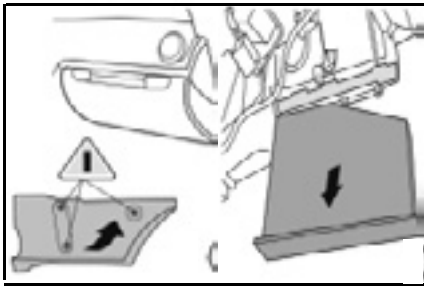
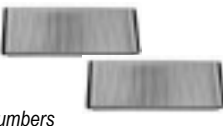
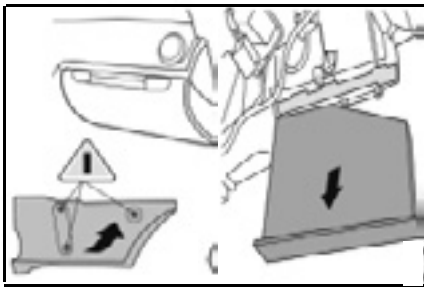
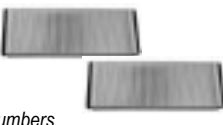

<p>--- SERIE 5 / M5 (E34) ---</p> 	<p>01/88 -> 09/96</p>	<p>*</p>	<p>*</p>	<p>CK 5935 330 x 165 x 24/34,5</p>  <p><u>O/E numbers</u> Bmw 64311390836</p> <p><u>Cross References</u> Fram CF5935 Mann CU3338 Micronair MP002 Purflux AH130 Tecocar E330 Fiaam PC8031</p>	
<p>--- SERIE 5 / M5 (E39) ---</p> 	<p>11/95 -> 07/04</p>	<p>*</p>	<p>*</p>	<p>CK 8912-2 275/257 x 202/192 x 30/34,5</p>  <p><u>O/E numbers</u> Bmw 64110088138 / 64319069927</p> <p><u>Cross References</u> Fram CF8912-2 Mann CU2736-2 Micronair MP030-2 Purflux AH134 Tecocar E333 Fiaam PC8054-2</p>	<p>CK 8912-C-2 275/257 x 202/192 x 30/34,5</p>  <p><u>O/E numbers</u> Bmw 64110008138</p> <p><u>Cross References</u> Fram CFA8912-2 Mann CUK2736-2 Micronair MC530-2 Purflux AHC134/AHC239 Tecocar EC443 Fiaam PCK8054-2</p>
<p>--- SERIE 5 (E60/E61) ---</p> 	<p>07/03 -> 12/10</p>	<p>*</p>	<p></p>	<p>CK 3139-2 321/316 x 177/171 x 29,5</p>  <p><u>O/E numbers</u> Bmw 64316935822</p> <p><u>Cross References</u> Fram CF10103-2 Mann CU3139-2 Micronair MP166-2 Purflux..... Tecocar..... Fiaam.....</p>	<p>CK 3139-C-2 321/316 x 177/171 x 29,5</p>  <p><u>O/E numbers</u> Bmw 643169835823</p> <p><u>Cross References</u> Fram CFA10103-2 Mann CUK3139-2 Micronair MC666-2 Purflux AHC219 Tecocar EC420-2 Fiaam PCK8168-2</p>
<p>--- SERIE 5 (F10/F11/F18) ---</p> 	<p>03/10 -></p>	<p>*</p>	<p>*</p>	<p>CK 2533-2 245 x 206 x 32</p>  <p><u>O/E numbers</u> Bmw 64119163328 / 64119272641</p> <p><u>Cross References</u> Fram CF11220-2 Mann CU2533-2 Micronair MP380-2 Pufux AH336-2 Tecocar E629-2 Fiaam PC8293-2</p>	
<p>--- SERIE 5 GT (F07GT) ---</p> 	<p>10/09 -></p>	<p>*</p>	<p>*</p>	<p>CK 2533-2 245 x 206 x 32</p>  <p><u>O/E numbers</u> Bmw 64119163328 / 64119272641</p> <p><u>Cross References</u> Fram CF11220-2 Mann CU2533-2 Micronair MP380-2 Pufux AH336-2 Tecocar E629-2 Fiaam PC8293-2</p>	





Anti-pollen

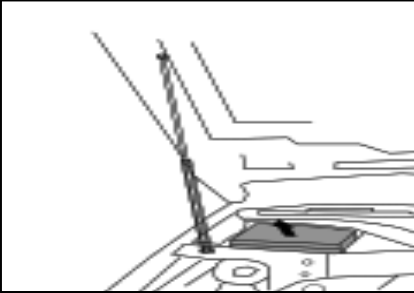

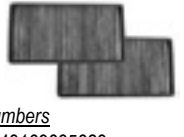
Activated carbon

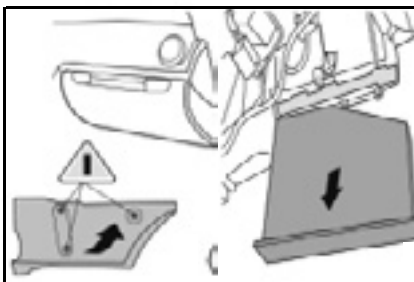

BMW

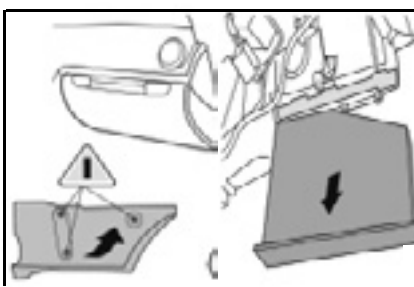
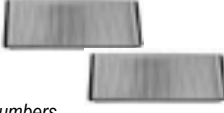
<p>--- SERIE 6 (E63/E64) ---</p>  <p> 1 Il filtro è posizionato nel vano motore GB The filter is located in the engine compartment F Le filtre est situé dans le compartiment moteur D Der Filter befindet sich im Motorraum E El filtro se encuentra en el compartimiento del motor </p>	<p>10/03 -> * *</p>	<p>CK 3139-2 321/316 x 177/171 x 29,5</p>  <p><u>O/E numbers</u> Bmw 64316935822 <u>Cross References</u> Fram CF10103-2 Mann CU3139-2 Micronair MP166-2 Purflux..... TecnoCar..... Fiaam.....</p>	<p>CK 3139-C-2 321/316 x 177/171 x 29,5</p>  <p><u>O/E numbers</u> Bmw 643169835823 <u>Cross References</u> Fram CFA10103-2 Mann CUK3139-2 Micronair MC666-2 Purflux AHC219 TecnoCar EC420-2 Fiaam PCK8168-2</p>
--	------------------------	--	--

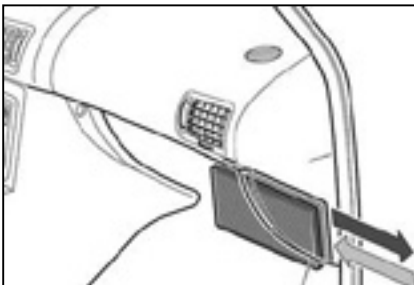
<p>--- SERIE 6 (F12/F13) ---</p>  <p> 1 Il filtro è posizionato nell'abitacolo sotto il vano portaoggetti GB The filter is located in the passenger compartment under the glove compartment F Le filtre est situé dans l'habitacle en dessous de la boîte à gants D Der filter befindet sich im Fahrgastraum unter dem Handshuhfach E El filtro se encuentra en el habitáculo, bajo la guantera de pasajerruimte </p>	<p>03/11 -> * *</p>	<p>CK 2533-2 245 x 206 x 32</p>  <p><u>O/E numbers</u> Bmw 64119163328 / 64119272641 <u>Cross References</u> Fram CF11220-2 Mann CU2533-2 Micronair MP380-2 Puflex AH336-2 TecnoCar E629-2 Fiaam PC8293-2</p>	<p>---</p>
--	------------------------	--	------------

<p>--- SERIE 6 GRAN COUPE' (F06GC) ---</p>  <p> 1 Il filtro è posizionato nell'abitacolo sotto il vano portaoggetti GB The filter is located in the passenger compartment under the glove compartment F Le filtre est situé dans l'habitacle en dessous de la boîte à gants D Der filter befindet sich im Fahrgastraum unter dem Handshuhfach E El filtro se encuentra en el habitáculo, bajo la guantera de pasajerruimte </p>	<p>05/12 -> * *</p>	<p>CK 2533-2 245 x 206 x 32</p>  <p><u>O/E numbers</u> Bmw 64119163328 / 64119272641 <u>Cross References</u> Fram CF11220-2 Mann CU2533-2 Micronair MP380-2 Puflex AH336-2 TecnoCar E629-2 Fiaam PC8293-2</p>	<p>---</p>
--	------------------------	--	------------

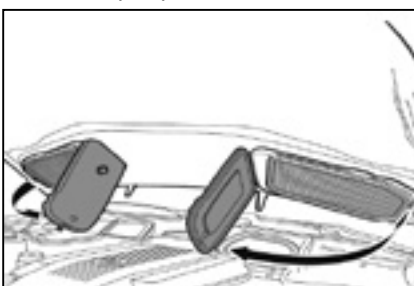
<p>--- SERIE 7 (E32) ---</p>  <p> 1 Il filtro è posizionato nell'abitacolo dietro il vano portaoggetti GB The filter is located in the passenger compartment behind the glove compartment F Le filtre est situé dans l'habitacle derrière la boîte à gants D Der filter befindet sich im Fahrgastraum hinter dem Handshuhfach E El filtro se encuentra en el habitáculo detrás de la guantera </p>	<p>09/86 -> 09/94 * *</p>	<p>CK 5935 330 x 165 x 24/34,5</p>  <p><u>O/E numbers</u> Bmw 64311390836 <u>Cross References</u> Fram CF5935 Mann CU3338 Micronair MP002 Purflux AH130 TecnoCar E330 Fiaam PC8031</p>	<p>---</p>
---	------------------------------	---	------------

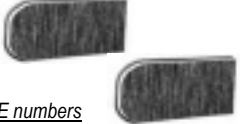
<p>--- SERIE 7 (E38) ---</p>  <p> 1 Il filtro è posizionato nel vano motore GB The filter is located in the engine compartment F Le filtre est situé dans le compartiment moteur D Der Filter befindet sich im Motorraum E El filtro se encuentra en el compartimiento del motor </p>	<p>10/94 -> 10/01 * *</p>	<p>CK 9322-2 384/356 x 180/170 x 30/37</p>  <p><u>O/E numbers</u> Bmw 64319069926 <u>Cross References</u> Fram..... Mann CU3642-2 Micronair MP093-2 Purflux TecnoCar..... Fiaam.....</p>	<p>CK 9322-C-2 384/356 x 180/170 x 30/37</p>  <p><u>O/E numbers</u> Bmw 64118390447 / 64319070072 <u>Cross References</u> Fram CFA9322 Mann CUK3642-2 Micronair MC593-2 Purflux..... TecnoCar..... Fiaam PCK8078</p>
--	------------------------------	---	--



Anti-pollen

Activated carbon

BMW

--- SERIE 7 (E65/E66) ---

09/01 -> 08/08

*

*

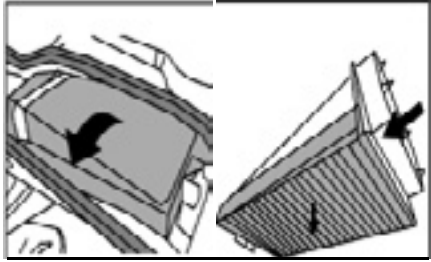

- I** Il filtro è posizionato nel vano motore al centro
- GB** The filter is located in the engine compartment centrally
- F** Le filtre est situé dans le compartiment moteur au centre
- D** Der Filter befindet sich im Motorraum mittig
- E** El filtro se encuentra en el compartimiento del motor, en el centro

CK 3124-10-2

232 x 172 x 29,5

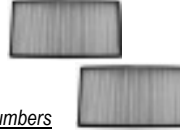

O/E numbers

Bmw 64116921018

Cross References

Fram..... Mann CU3124-2
Micronair MP111-2 Purflux
Tecnocar..... Fiaam.....

CK 3124-10-C-2

232 x 172 x 29,5



O/E numbers

Bmw 64116921019

Cross References

Fram..... Mann CUK3124-2
Micronair MC611-2 Purflux.....
Tecnocar..... Fiaam.....

--- SERIE 7 (F01/F02/F03/F04) ---

10/08 ->

*

*

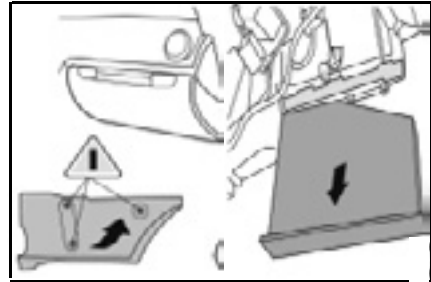

- I** Il filtro è posizionato nell'abitacolo sotto il vano portaoggetti
- GB** The filter is located in the passenger compartment under the glove compartment
- F** Le filtre est situé dans l'habitacle en dessous de la boîte à gants
- D** Der filter befindet sich im Fahrgastraum unter dem Handshuhfach
- E** El filtro se encuentra en el habitáculo, bajo la guantera de pasajerruimte

CK 2533-2

245 x 206 x 32



O/E numbers

Bmw 64119163328 / 64119272641

Cross References

Fram CF11220-2 Mann CU2533-2
Micronair MP380-2 Puflex AH336-2
Tecnocar E629-2 Fiaam PC8293-2

--- X1 (E84) ---

10/09 ->

*



- I** Il filtro è posizionato nel vano motore al centro
- GB** The filter is located in the engine compartment centrally
- F** Le filtre est situé dans le compartiment moteur au centre
- D** Der Filter befindet sich im Motorraum mittig
- E** El filtro se encuentra en el compartimiento del motor, en el centro

CK 8430

834 x 134 x 26



O/E numbers

Bmw 64316946629 / 64316962548

Cross References

Fram CF10207 Mann CU8430
Micronair MP195 Purflux AH246
Tecnocar..... Fiaam PC8172

CK 8430-C

834 x 134 x 26



O/E numbers

Bmw 64316946628 / 64316962549

Cross References

Fram CFA10206 Mann CUK8430
Micronair MC695 Purflux AHC246
Tecnocar EC448 Fiaam PCK8172

--- X1 (F48) ---

06/15 ->

*

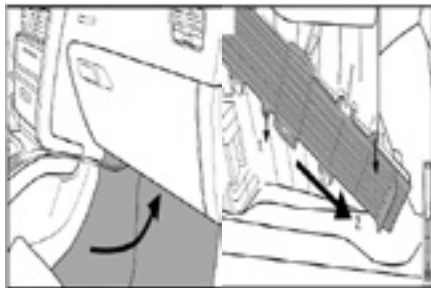

- I** Il filtro è posizionato nell'abitacolo dietro il vano portaoggetti
- GB** The filter is located in the passenger compartment behind the glove compartment
- F** Le filtre est situé dans l'habitacle derrière la boîte à gants
- D** Der filter befindet sich im Fahrgastraum hinter dem Handshuhfach
- E** El filtro se encuentra en el habitáculo detrás de la guantera

CK 23005-C-2

232 x 116 x 32

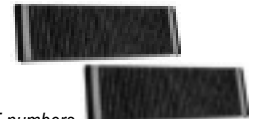

O/E numbers

Bmw 64119321875 / 64319297750

Cross References

Fram CFA11815-2 Mann CUK 23005-2
Micronair Puflex AHC428-2
Tecnocar EC722-2 Fiaam PCK8408-2

--- X3 (E83) ---

12/03 -> 12/10

*

*



- I** Il filtro è posizionato nel vano motore al centro
- GB** The filter is located in the engine compartment centrally
- F** Le filtre est situé dans le compartiment moteur au centre
- D** Der Filter befindet sich im Motorraum mittig
- E** El filtro se encuentra en el compartimiento del motor, en el centro

CK 8913

668 x 103 x 23,6



O/E numbers

Bmw 64319071934 / 64318361899

Cross References

Fram CF8913 Mann CU6724
Micronair MP038 Purflux AH187
Tecnocar..... Fiaam PC8053

CK 8913-C

668 x 103 x 23,6



O/E numbers

Bmw 64319071935

Cross References

Fram CFA8913 Mann CUK6724
Micronair MC538 Purflux AHC187
Tecnocar EC390 Fiaam PCK8053



Anti-pollen

Activated carbon

BMW

--- X3 (F25) ---

11/10 ->

*



- I** Il filtro è posizionato nel vano motore al centro
- GB** The filter is located in the engine compartment centrally
- F** Le filtre est situé dans le compartiment moteur au centre
- D** Der Filter befindet sich im Motorraum mittig
- E** El filtro se encuentra en el compartimiento del motor, en el centro

CK 19004-2

188 x 188 x 25

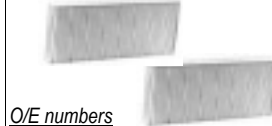

O/E numbers

Bmw 64312284827 / 64319237158

Cross References

Fram CF11471-2 Mann CU19004
Micronair Purflux AH372-2
Tecocar E666-2 Fiaam PC8341-2

CK 19004-2-C

188 x 188 x 25

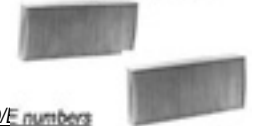

O/E numbers

Bmw 64312284828 / 64319237157

Cross References

Fram CFA11471-2 Mann CUK19004
Micronair MC922 Purflux AHC372-2
Tecocar EC666-2 Fiaam PCK8341-2

--- X3 (F25) --- with automatic climate control

11/10 ->

*

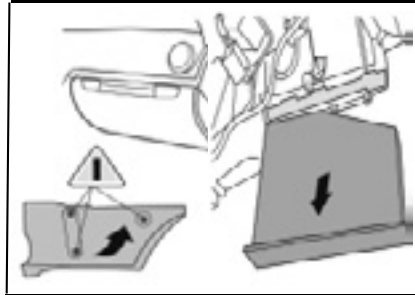

- I** Il filtro è posizionato nell'abitacolo sotto il vano portaoggetti
- GB** The filter is located in the passenger compartment under the glove compartment
- F** Le filtre est situé dans l'habitacle en dessous de la boîte à gants
- D** Der filter befindet sich im Fahrgastraum unter dem Handshuhfach
- E** El filtro se encuentra en el habitáculo, bajo la guantera de pasajerruimte

CK1721-2

164 x 88 x 30



O/E numbers

Bmw 64119237159

Cross References

Fram Mann CU1721-2
Micronair MP458-2 Purflux AH385-2
Tecocar E677-2 Fiaam

CK 1721-2-C

164 x 88 x 30



O/E numbers

Bmw

Cross References

Fram Mann
Micronair Purflux
Tecocar Fiaam

--- X4 (F25) ---

04/14 ->

*

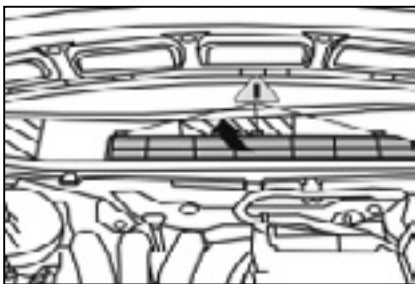

- I** Il filtro è posizionato nel vano motore al centro
- GB** The filter is located in the engine compartment centrally
- F** Le filtre est situé dans le compartiment moteur au centre
- D** Der Filter befindet sich im Motorraum mittig
- E** El filtro se encuentra en el compartimiento del motor, en el centro

CK 19004-2

188 x 188 x 25

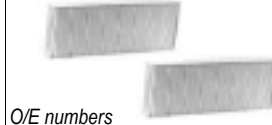

O/E numbers

Bmw 64312284827 / 64319237158

Cross References

Fram CF11471-2 Mann CU19004
Micronair Purflux AH372-2
Tecocar E666-2 Fiaam PC8341-2

CK 19004-2-C

188 x 188 x 25

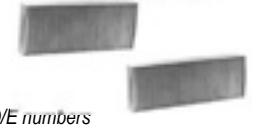

O/E numbers

Bmw 64312284828 / 64319237157

Cross References

Fram CFA11471-2 Mann CUK19004
Micronair MC922 Purflux AHC372-2
Tecocar EC666-2 Fiaam PCK8341-2

--- X4 (F25) --- with automatic climate control

04/14 ->

*

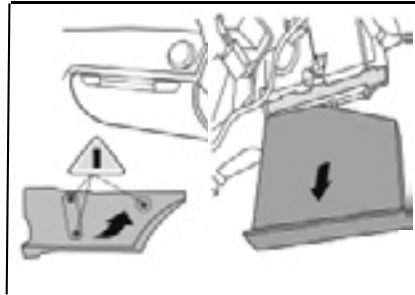

- I** Il filtro è posizionato nell'abitacolo sotto il vano portaoggetti
- GB** The filter is located in the passenger compartment under the glove compartment
- F** Le filtre est situé dans l'habitacle en dessous de la boîte à gants
- D** Der filter befindet sich im Fahrgastraum unter dem Handshuhfach
- E** El filtro se encuentra en el habitáculo, bajo la guantera de pasajerruimte

CK1721-2

164 x 88 x 30



O/E numbers

Bmw 64119237159

Cross References

Fram Mann CU1721-2
Micronair MP458-2 Purflux AH385-2
Tecocar E677-2 Fiaam

CK 1721-2-C

164 x 88 x 30



O/E numbers

Bmw

Cross References

Fram Mann
Micronair Purflux
Tecocar Fiaam

--- X5 (E53) ---

03/00 -> 12/06

*

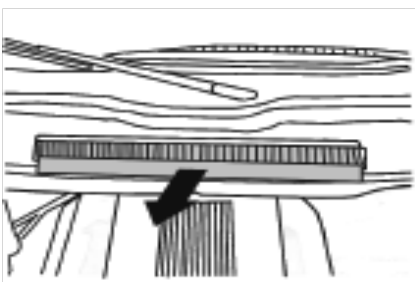

- I** Il filtro è posizionato nel vano motore sul lato passeggero
- GB** The filter is located in the engine compartment on the passenger's side
- F** Le filtre est situé dans le compartiment moteur du côté passager
- D** Der filter befindet sich Motorraum auf der Beifahrerseite
- E** El filtro se encuentra en el compartimiento del motor, del lado del acompañante

CK 5366

540 x 260 x 31,5



O/E numbers

Bmw 64318409043

Cross References

Fram Mann CU5366
Micronair MP149 Purflux.....
Tecocar..... Fiaam.....

CK 5366-C

540 x 260 x 31,5



O/E numbers

Bmw 64318409044

Cross References

Fram CFA10830 Mann CUK5366
Micronair MC649 Purflux AHC299
Tecocar EC609 Fiaam PCK8262



Anno di fabbricazione / Year of construction
Anné de fabrication / Baujahr / Año de fabricación



Con climatizzatore / With air-conditioning / Avec climatisation
Mit Klimaanlage / Con instalación de aire acondicionado





Senza climatizzatore / Without air-conditioning / Sans climatisation
Ohne Klimaanlage / Sin instalación de aire acondicionado





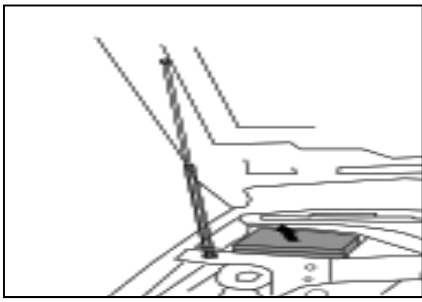

Anti-pollen

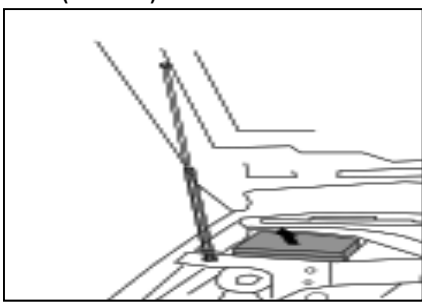

Activated carbon

BMW

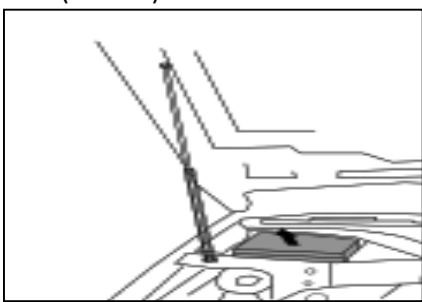
<p>--- X5 (E70) ---</p>  <p> <input type="checkbox"/> Il filtro è posizionato nel vano motore <input checked="" type="checkbox"/> The filter is located in the engine compartment <input type="checkbox"/> Le filtre est situé dans le compartiment moteur <input type="checkbox"/> Der Filter befindet sich im Motorraum <input type="checkbox"/> El filtro se encuentra en el compartimiento del motor </p>	<p>11/06 -> * <input type="checkbox"/></p>	<p>CK 2941-2 292 x 139 x 34</p>  <p><u>O/E numbers</u> Bmw 64316945585 / 64316945593</p> <p><u>Cross References</u> Fram Mann CU2941-2 Micronair Purflux..... Tecocar..... Fiaam.....</p>	<p>CK 2941-C-2 292 x 139 x 34</p>  <p><u>O/E numbers</u> Bmw 64119248294 / 64316945586</p> <p><u>Cross References</u> Fram CFA10103-2 Mann CUK2941-2 Micronair Purflux AHC349-2 Tecocar Fiaam PCK8307-2</p>
---	---	--	---

<p>--- X5 (F15/F85) ---</p>  <p> <input type="checkbox"/> Il filtro è posizionato nel vano motore <input checked="" type="checkbox"/> The filter is located in the engine compartment <input type="checkbox"/> Le filtre est situé dans le compartiment moteur <input type="checkbox"/> Der Filter befindet sich im Motorraum <input type="checkbox"/> El filtro se encuentra en el compartimiento del motor </p>	<p>10/13 -> * <input type="checkbox"/></p>	<p>CK 2941-2 292 x 139 x 34</p>  <p><u>O/E numbers</u> Bmw 64316945585 / 64316945593</p> <p><u>Cross References</u> Fram Mann CU2941-2 Micronair Purflux..... Tecocar..... Fiaam.....</p>	<p>CK 2941-C-2 292 x 139 x 34</p>  <p><u>O/E numbers</u> Bmw 64119248294 / 64316945586</p> <p><u>Cross References</u> Fram CFA10103-2 Mann CUK2941-2 Micronair Purflux AHC349-2 Tecocar Fiaam PCK8307-2</p>
---	---	--	---

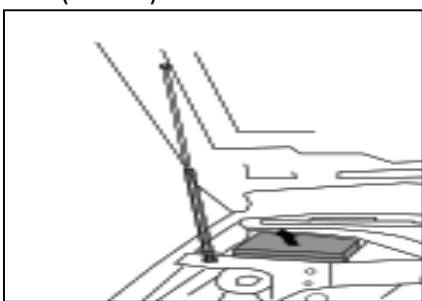
<p>--- X6 (E71/E72) ---</p>  <p> <input type="checkbox"/> Il filtro è posizionato nel vano motore <input checked="" type="checkbox"/> The filter is located in the engine compartment <input type="checkbox"/> Le filtre est situé dans le compartiment moteur <input type="checkbox"/> Der Filter befindet sich im Motorraum <input type="checkbox"/> El filtro se encuentra en el compartimiento del motor </p>	<p>04/08 -> * <input type="checkbox"/></p>	<p>CK 2941-2 292 x 139 x 34</p>  <p><u>O/E numbers</u> Bmw 64316945585 / 64316945593</p> <p><u>Cross References</u> Fram Mann CU2941-2 Micronair Purflux..... Tecocar..... Fiaam.....</p>	<p>CK 2941-C-2 292 x 139 x 34</p>  <p><u>O/E numbers</u> Bmw 64119248294 / 64316945586</p> <p><u>Cross References</u> Fram CFA10103-2 Mann CUK2941-2 Micronair Purflux AHC349-2 Tecocar Fiaam PCK8307-2</p>
---	---	--	---

<p>--- X6 (F16/F86) ---</p>  <p> <input type="checkbox"/> Il filtro è posizionato nel vano motore <input checked="" type="checkbox"/> The filter is located in the engine compartment <input type="checkbox"/> Le filtre est situé dans le compartiment moteur <input type="checkbox"/> Der Filter befindet sich im Motorraum <input type="checkbox"/> El filtro se encuentra en el compartimiento del motor </p>	<p>09/14 -> * <input type="checkbox"/></p>	<p>CK 2941-2 292 x 139 x 34</p>  <p><u>O/E numbers</u> Bmw 64316945585 / 64316945593</p> <p><u>Cross References</u> Fram Mann CU2941-2 Micronair Purflux..... Tecocar..... Fiaam.....</p>	<p>CK 2941-C-2 292 x 139 x 34</p>  <p><u>O/E numbers</u> Bmw 64119248294 / 64316945586</p> <p><u>Cross References</u> Fram CFA10103-2 Mann CUK2941-2 Micronair Purflux AHC349-2 Tecocar Fiaam PCK8307-2</p>
---	---	--	---

<p> </p>	<p> </p>	<p> </p>
----------	----------	----------



Anti-pollen

Activated carbon

BMW ALPINA B. BOVENSIEPEN

--- B5 (F10/F11) ---

10/08 -> * *

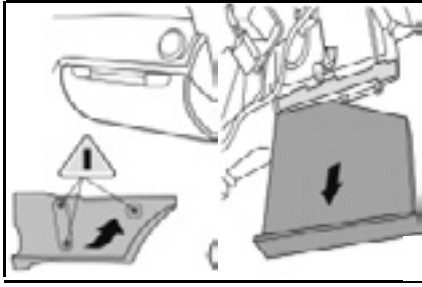

- I** Il filtro è posizionato nell'abitacolo sotto il vano portaoggetti
- GB** The filter is located in the passenger compartment under the glove compartment
- F** Le filtre est situé dans l'habitacle en dessous de la boîte à gants
- D** Der filter befindet sich im Fahrgastraum unter dem Handsuhfach
- E** El filtro se encuentra en el habitáculo, bajo la guantera de pasajerruimte

CK 2533-2

245 x 206 x 32



O/E numbers

Bmw 64119163328 / 64119272641

Cross References

Fram CF11220-2 Mann CU2533-2
Micronair MP380-2 Puflex AH336-2
TecnoCar E629-2 Fiaam PC8293-2

--- B6 (F06) ---

03/14-> * *

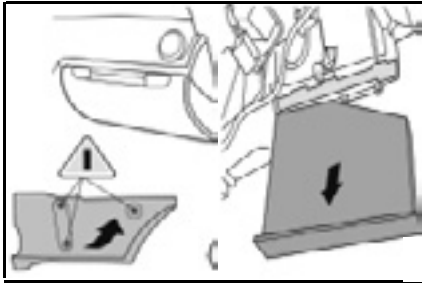

- I** Il filtro è posizionato nell'abitacolo sotto il vano portaoggetti
- GB** The filter is located in the passenger compartment under the glove compartment
- F** Le filtre est situé dans l'habitacle en dessous de la boîte à gants
- D** Der filter befindet sich im Fahrgastraum unter dem Handsuhfach
- E** El filtro se encuentra en el habitáculo, bajo la guantera de pasajerruimte

CK 2533-2

245 x 206 x 32



O/E numbers

Bmw 64119163328 / 64119272641

Cross References

Fram CF11220-2 Mann CU2533-2
Micronair MP380-2 Puflex AH336-2
TecnoCar E629-2 Fiaam PC8293-2

--- B6 (F12/F13) ---

09/11-> * *

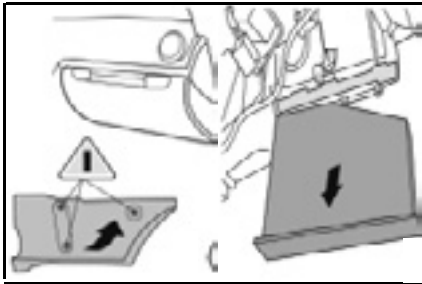

- I** Il filtro è posizionato nell'abitacolo sotto il vano portaoggetti
- GB** The filter is located in the passenger compartment under the glove compartment
- F** Le filtre est situé dans l'habitacle en dessous de la boîte à gants
- D** Der filter befindet sich im Fahrgastraum unter dem Handsuhfach
- E** El filtro se encuentra en el habitáculo, bajo la guantera de pasajerruimte

CK 2533-2

245 x 206 x 32



O/E numbers

Bmw 64119163328 / 64119272641

Cross References

Fram CF11220-2 Mann CU2533-2
Micronair MP380-2 Puflex AH336-2
TecnoCar E629-2 Fiaam PC8293-2

--- B7 (F01/F02) ---

02/10-> * *

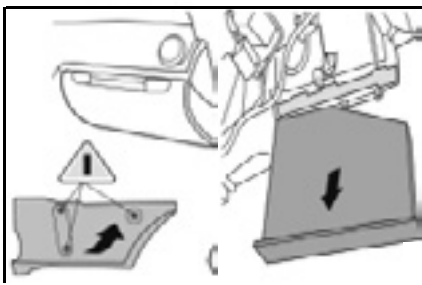

- I** Il filtro è posizionato nell'abitacolo sotto il vano portaoggetti
- GB** The filter is located in the passenger compartment under the glove compartment
- F** Le filtre est situé dans l'habitacle en dessous de la boîte à gants
- D** Der filter befindet sich im Fahrgastraum unter dem Handsuhfach
- E** El filtro se encuentra en el habitáculo, bajo la guantera de pasajerruimte

CK 2533-2

245 x 206 x 32



O/E numbers

Bmw 64119163328 / 64119272641

Cross References

Fram CF11220-2 Mann CU2533-2
Micronair MP380-2 Puflex AH336-2
TecnoCar E629-2 Fiaam PC8293-2

--- D5 (F10/F11) ---

10/11-> * *

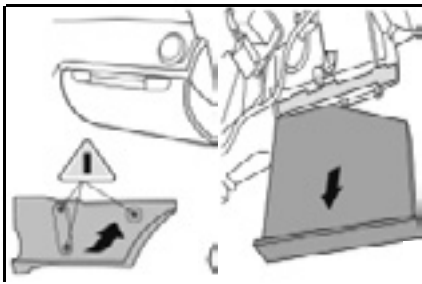

- I** Il filtro è posizionato nell'abitacolo sotto il vano portaoggetti
- GB** The filter is located in the passenger compartment under the glove compartment
- F** Le filtre est situé dans l'habitacle en dessous de la boîte à gants
- D** Der filter befindet sich im Fahrgastraum unter dem Handsuhfach
- E** El filtro se encuentra en el habitáculo, bajo la guantera de pasajerruimte

CK 2533-2

245 x 206 x 32



O/E numbers

Bmw 64119163328 / 64119272641

Cross References

Fram CF11220-2 Mann CU2533-2
Micronair MP380-2 Puflex AH336-2
TecnoCar E629-2 Fiaam PC8293-2



Anti-pollen

Activated carbon

BMW ALPINA B. BOVENSIEPEN

--- XD3 (F25) ---

03/13 ->

*



- I** Il filtro è posizionato nel vano motore al centro
- GB** The filter is located in the engine compartment centrally
- F** Le filtre est situé dans le compartiment moteur au centre
- D** Der Filter befindet sich im Motorraum mittig
- E** El filtro se encuentra en el compartimiento del motor, en el centro

CK 19004-2

188 x 188 x 25

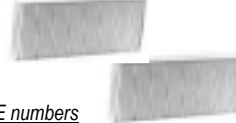

O/E numbers

Bmw 64312284827 / 64319237158

Cross References

Fram CF11471-2 Mann CU19004
 Micronair Purflux AH372-2
 Tecnocar E666-2 Fiaam PC8341-2

CK 19004-2-C

188 x 188 x 25

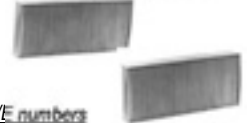

O/E numbers

Bmw 64312284828 / 64319237157

Cross References

Fram CFA11471-2 Mann CUK19004
 Micronair MC922 Purflux AHC372-2
 Tecnocar EC666-2 Fiaam PCK8341-2

--- XD3 (F25) --- with automatic climate control

04/14 ->

*

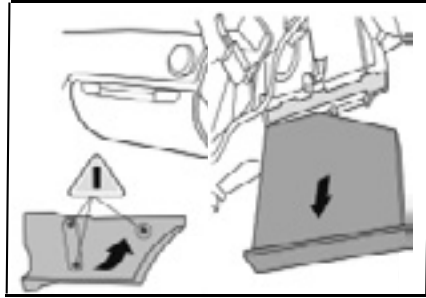

- I** Il filtro è posizionato nell'abitacolo sotto il vano portaoggetti
- GB** The filter is located in the passenger compartment under the glove compartment
- F** Le filtre est situé dans l'habitacle en dessous de la boîte à gants
- D** Der filter befindet sich im Fahrgastraum unter dem Handshuhfach
- E** El filtro se encuentra en el habitáculo, bajo la guantera/in de pasajerruimte

CK1721-2

164 x 88 x 30



O/E numbers

Bmw 64119237159

Cross References

Fram Mann CU1721-2
 Micronair MP458-2 Purflux AH385-2
 Tecnocar E677-2 Fiaam

CK 1721-2-C

164 x 88 x 30



O/E numbers

Bmw

Cross References

Fram Mann
 Micronair Purflux
 Tecnocar Fiaam

--	--	--

--	--	--

--	--	--



Anti-pollen

Activated carbon

CHEVROLET / DAEWOO

--- Aveo ---

01/05 ->

*

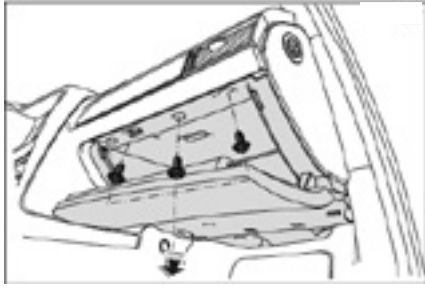

- I Il filtro è posizionato nell'abitacolo sotto il vano portaoggetti
- GB The filter is located in the passenger compartment under the glove compartment
- F Le filtre est situé dans l'habitacle en dessous de la boîte à gants
- D Der filter befindet sich im Fahrgastraum unter dem Handshuhfach
- E El filtro se encuentra en el habitáculo, bajo la guantera de pasajero

CK 2330

246 x 200 x 19



O/E numbers

Daewoo 4F0819439 / 4F0898438

Cross References

Fram CF10546 Mann CU2330
Micronair MP120 Purflux AH347
Tecnocar E641 Fiaam PC8305

--- Aveo II ---

03/11 ->

*

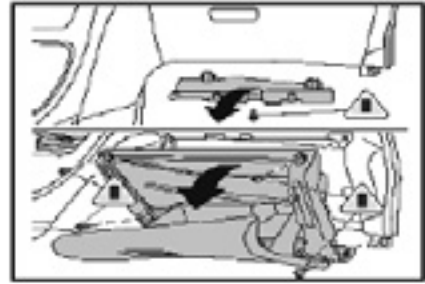

- I Il filtro è posizionato nell'abitacolo dietro il vano portaoggetti
- GB The filter is located in the passenger compartment behind the glove compartment
- F Le filtre est situé dans l'habitacle derrière la boîte à gants
- D Der filter befindet sich im Fahrgastraum hinter dem Handshuhfach
- E El filtro se encuentra en el habitáculo detrás de la guantera

CK 10774

239 x 204 x 35



O/E numbers

Chevrolet/Daewoo 13271190

Cross References

Fram CF10774 Mann CU2442
Micronair MP366 Purflux AH286
Tecnocar E603 Fiaam PC8255

CK 10774-C

239 x 204 x 35



O/E numbers

Chevrolet/Daewoo 13271191

Cross References

Fram CFA10775 Mann CUK2442
Micronair MC866 Purflux AHC286
Tecnocar EC603 Fiaam PCK8255

--- Captiva I+II ---

09/06 ->

*

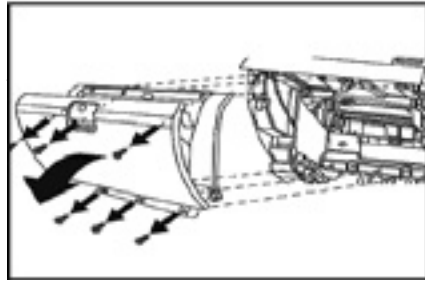

- I Il filtro è posizionato nell'abitacolo dietro il vano portaoggetti
- GB The filter is located in the passenger compartment behind the glove compartment
- F Le filtre est situé dans l'habitacle derrière la boîte à gants
- D Der filter befindet sich im Fahrgastraum hinter dem Handshuhfach
- E El filtro se encuentra en el habitáculo detrás de la guantera

CK 2622

264 x 198 x 26,5

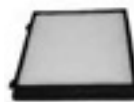

O/E numbers

Opel 4803383

Cross References

Fram CF11166 Man CU2622
Micronair MP285 Purflux AH307
Tecnocar Fiaam PC8265

CK 2622-C

264 x 198 x 26,5



O/E numbers

Opel 4819126

Cross References

Fram Mann CUK2622
Micronair MC785 Purflux
Tecnocar Fiaam

--- Cobalt ---

01/14 ->

*



- I Il filtro è posizionato nell'abitacolo dietro il vano portaoggetti
- GB The filter is located in the passenger compartment behind the glove compartment
- F Le filtre est situé dans l'habitacle derrière la boîte à gants
- D Der filter befindet sich im Fahrgastraum hinter dem Handshuhfach
- E El filtro se encuentra en el habitáculo detrás de la guantera

CK 10774

239 x 204 x 35



O/E numbers

Chevrolet/Daewoo 13271190

Cross References

Fram CF10774 Mann CU2442
Micronair MP366 Purflux AH286
Tecnocar E603 Fiaam PC8255

CK 10774-C

239 x 204 x 35



O/E numbers

Chevrolet/Daewoo 13271191

Cross References

Fram CFA10775 Mann CUK2442
Micronair MC866 Purflux AHC286
Tecnocar EC603 Fiaam PCK8255

--- Cruze ---

03/09 ->

*



- I Il filtro è posizionato nell'abitacolo dietro il vano portaoggetti
- GB The filter is located in the passenger compartment behind the glove compartment
- F Le filtre est situé dans l'habitacle derrière la boîte à gants
- D Der filter befindet sich im Fahrgastraum hinter dem Handshuhfach
- E El filtro se encuentra en el habitáculo detrás de la guantera

CK 10774

239 x 204 x 35



O/E numbers

Chevrolet/Daewoo 13271190

Cross References

Fram CF10774 Mann CU2442
Micronair MP366 Purflux AH286
Tecnocar E603 Fiaam PC8255

CK 10774-C

239 x 204 x 35



O/E numbers

Chevrolet/Daewoo 13271191

Cross References









Fram CFA10775 Mann CUK2442
Micronair MC866 Purflux AHC286
Tecnocar EC603 Fiaam PCK8255

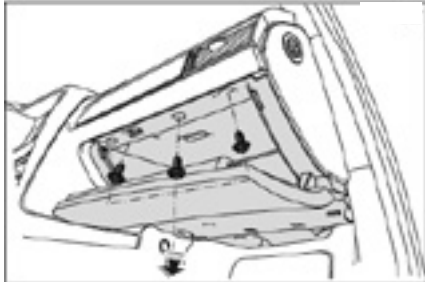

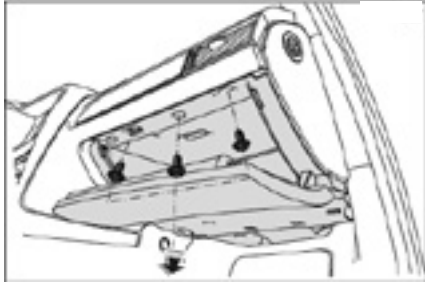
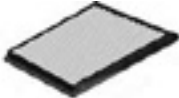
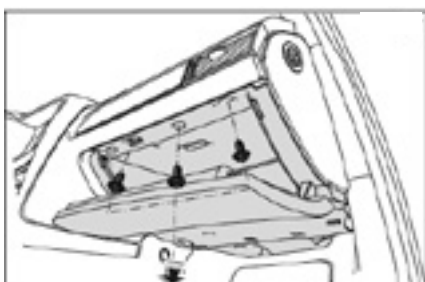
Anti-pollen

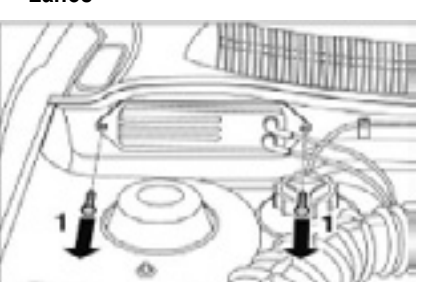
Activated carbon

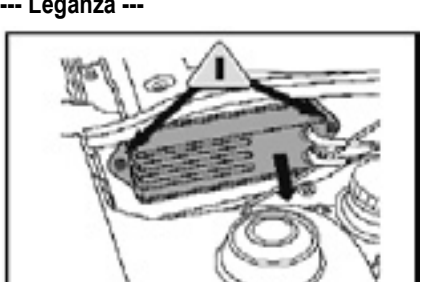
CHEVROLET / DAEWOO



<p>--- Gentra (Uz-Daewoo) ----</p> 	<p>11/13 -> * <input type="checkbox"/></p> <p>I Il filtro è posizionato nell'abitacolo sotto il vano portaoggetti GB The filter is located in the passenger compartment under the glove compartment F Le filtre est situé dans l'habitacle en dessous de la boîte à gants D Der filter befindet sich im Fahrgastraum unter dem Handsuhfach E El filtro se encuentra en el habitáculo, bajo la guanterain de pasajerruimte</p>	<p>CK 1719 224 x 190 x 25</p>  <p><u>O/E numbers</u> Daewoo 96554378 / 96554421</p> <p><u>Cross References</u> Fram CF10526 Mann CU1719 Micronair MP342 Puf flux AH305 Tecno car E485 Fiaam PC8215</p>	<p>---</p>
<p>--- Kalos ---</p> 	<p>09/02 -> * <input type="checkbox"/></p> <p>I Il filtro è posizionato nell'abitacolo sotto il vano portaoggetti GB The filter is located in the passenger compartment under the glove compartment F Le filtre est situé dans l'habitacle en dessous de la boîte à gants D Der filter befindet sich im Fahrgastraum unter dem Handsuhfach E El filtro se encuentra en el habitáculo, bajo la guanterain de pasajerruimte</p>	<p>CK 2330 246 x 200 x 19</p>  <p><u>O/E numbers</u> Daewoo 4F0819439 / 4F0898438</p> <p><u>Cross References</u> Fram CF10546 Mann CU2330 Micronair MP120 Puf flux AH347 Tecno car E641 Fiaam PC8305</p>	<p>---</p>
<p>--- Lacetti ----</p> 	<p>03/04 -> * <input type="checkbox"/></p> <p>I Il filtro è posizionato nell'abitacolo sotto il vano portaoggetti GB The filter is located in the passenger compartment under the glove compartment F Le filtre est situé dans l'habitacle en dessous de la boîte à gants D Der filter befindet sich im Fahrgastraum unter dem Handsuhfach E El filtro se encuentra en el habitáculo, bajo la guanterain de pasajerruimte</p>	<p>CK 1719 224 x 190 x 25</p>  <p><u>O/E numbers</u> Daewoo 96554378 / 96554421</p> <p><u>Cross References</u> Fram CF10526 Mann CU1719 Micronair MP342 Puf flux AH305 Tecno car E485 Fiaam PC8215</p>	<p>---</p>
<p>--- Lanos ---</p> 	<p>07/97 -> * *</p> <p>I Il filtro è posizionato nel vano motore sul lato passeggero GB The filter is located in the engine compartment on the passenger's side F Le filtre est situé dans le compartiment moteur du côté passager D Der filter befindet sich Motorraum auf der Beifahrerseite E El filtro se encuentra en el compartimiento del motor, del lado del acompañante</p>	<p>CK 9395 227/221 x 196/186 x 25</p>  <p><u>O/E numbers</u> Chevrolet/Daewoo 96190645</p> <p><u>Cross References</u> Fram CF9395 Mann CU2337 Micronair MP042 Purflux AH226 Tecno car E425 Fiaam PC8087</p>	<p>---</p>
<p>--- Leganza ---</p> 	<p>03/97 -> * *</p> <p>I Il filtro è posizionato nel vano motore sul lato passeggero GB The filter is located in the engine compartment on the passenger's side F Le filtre est situé dans le compartiment moteur du côté passager D Der filter befindet sich Motorraum auf der Beifahrerseite E El filtro se encuentra en el compartimiento</p>	<p>CK 9394 269/259 x 198/186 x 24/31</p>  <p><u>O/E numbers</u> Chevrolet/Daewoo 96207422</p> <p><u>Cross References</u> Fram CF9394 Mann CU2645 Micronair MP043 Purflux.....</p>	<p>---</p>





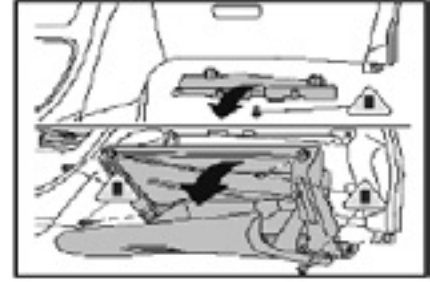

Anti-pollen



Activated carbon

CHEVROLET / DAEWOO

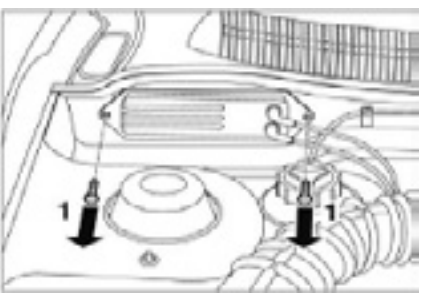
--- Malibu ---	01/12 -> * <input type="checkbox"/>	 <p>I Il filtro è posizionato nell'abitacolo dietro il vano portaoggetti GB The filter is located in the passenger compartment behind the glove compartment F Le filtre est situé dans l'habitacle derrière la boîte à gants D Der filter befindet sich im Fahrgastraum hinter dem Handshuhfach E El filtro se encuentra en el habitáculo detrás de la guantera</p>	<p>CK 10774 239 x 204 x 35</p>  <p><u>O/E numbers</u> Chevrolet/Daewoo 13271190 <u>Cross References</u> Fram CF10774 Mann CU2442 Micronair MP366 Purflux AH286 Tecnocar E603 Fiaam PC8255</p>	<p>CK 10774-C 239 x 204 x 35</p>  <p><u>O/E numbers</u> Chevrolet/Daewoo 13271191 <u>Cross References</u> Fram CFA10775 Mann CUK2442 Micronair MC866 Purflux AHC286 Tecnocar EC603 Fiaam PCK8255</p>
----------------	-------------------------------------	--	--	--

--- Matiz ---	06/05 -> * <input type="checkbox"/>	 <p>I Il filtro è posizionato nell'abitacolo dietro il vano portaoggetti GB The filter is located in the passenger compartment behind the glove compartment F Le filtre est situé dans l'habitacle derrière la boîte à gants D Der filter befindet sich im Fahrgastraum hinter dem Handshuhfach E El filtro se encuentra en el habitáculo detrás de la guantera</p>	<p>CK 2012 199 x 196 x 10</p>  <p><u>O/E numbers</u> Chevrolet/Daewoo 96425700 <u>Cross References</u> Fram CF11414 Mann CU2012 Micronair MP333 Purflux AH354 Tecnocar E647 Fiaam PC8322</p>	<p>---</p>
---------------	-------------------------------------	--	---	------------

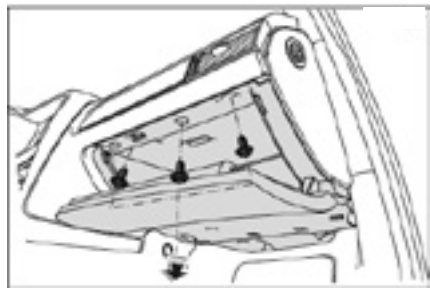
--- Nubira I ---	11/96 -> * <input type="checkbox"/> * <input type="checkbox"/>	 <p>I Il filtro è posizionato nel vano motore sul lato passeggero GB The filter is located in the engine compartment on the passenger's side F Le filtre est situé dans le compartiment moteur du côté passager D Der filter befindet sich im Motorraum auf der Beifahrerseite E El filtro se encuentra en el compartimiento del motor, del lado del acompañante</p>	<p>CK 9395 227/221 x 196/186 x 25</p>  <p><u>O/E numbers</u> Chevrolet/Daewoo 96190645 <u>Cross References</u> Fram CF9395 Mann CU2337 Micronair MP042 Purflux AH226 Tecnocar E425 Fiaam PC8087</p>	<p>---</p>
------------------	--	---	--	------------

--- Nubira II ---	05/04 -> * <input type="checkbox"/>	 <p>I Il filtro è posizionato nell'abitacolo sotto il vano portaoggetti GB The filter is located in the passenger compartment under the glove compartment F Le filtre est situé dans l'habitacle en dessous de la boîte à gants D Der filter befindet sich im Fahrgastraum unter dem Handshuhfach E El filtro se encuentra en el habitáculo, bajo la guantera en el compartimiento de pasajero</p>	<p>CK 1719 224 x 190 x 25</p>  <p><u>O/E numbers</u> Daewoo 96554378 / 96554421 <u>Cross References</u> Fram CF10526 Mann CU1719 Micronair MP342 Purflux AH305 Tecnocar E485 Fiaam PC8215</p>	<p>---</p>
-------------------	-------------------------------------	---	--	------------

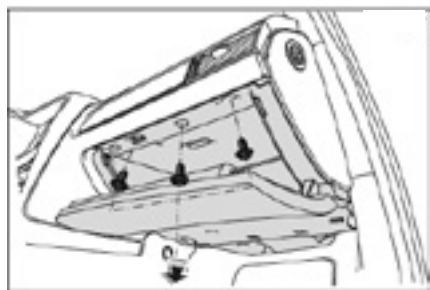
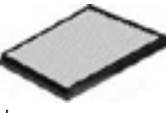

--- Optra ---	07/03 -> * <input type="checkbox"/>	 <p>I Il filtro è posizionato nell'abitacolo sotto il vano portaoggetti GB The filter is located in the passenger compartment under the glove compartment F Le filtre est situé dans l'habitacle en dessous de la boîte à gants D Der filter befindet sich im Fahrgastraum unter dem Handshuhfach E El filtro se encuentra en el habitáculo, bajo la guantera en el compartimiento de pasajero</p>	<p>CK 1719 224 x 190 x 25</p>  <p><u>O/E numbers</u> Daewoo 96554378 / 96554421 <u>Cross References</u> Fram CF10526 Mann CU1719 Micronair MP342 Purflux AH305 Tecnocar E485 Fiaam PC8215</p>	<p>---</p>
---------------	-------------------------------------	---	--	------------





Anti-pollen



Activated carbon

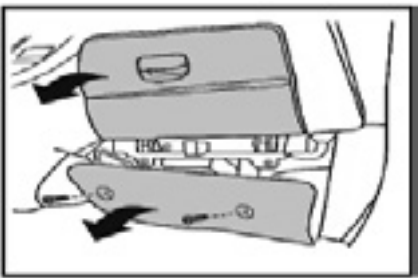

CHEVROLET / DAEWOO

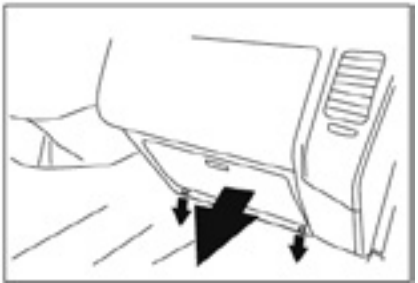
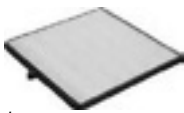
<p>--- Orlando ---</p>  <p>Il filtro è posizionato nell'abitacolo dietro il vano portaoggetti The filter is located in the passenger compartment behind the glove compartment Le filtre est situé dans l'habitacle derrière la boîte à gants Der filter befindet sich im Fahrgastraum hinter dem Handshuhfach El filtro se encuentra en el habitáculo detrás de la guantera</p>	<p>10/12 -> * </p>	<p>CK 10774 239 x 204 x 35</p>  <p><u>O/E numbers</u> Chevrolet/Daewoo 13271190 <u>Cross References</u> Fram CF10774 Mann CU2442 Micronair MP366 Purflux AH286 Tecnocar E603 Fiaam PC8255</p>	<p>CK 10774-C 239 x 204 x 35</p>  <p><u>O/E numbers</u> Chevrolet/Daewoo 13271191 <u>Cross References</u> Fram CFA10775 Mann CUK2442 Micronair MC866 Purflux AHC286 Tecnocar EC603 Fiaam PCK8255</p>
---	-----------------------	--	--

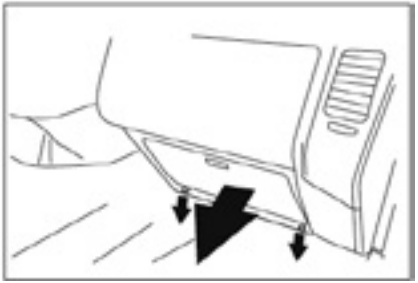
<p>--- Rezzo (Tacuma) / Tacuma ---</p>  <p>Il filtro è posizionato nell'abitacolo dietro il vano portaoggetti The filter is located in the passenger compartment behind the glove compartment Le filtre est situé dans l'habitacle derrière la boîte à gants Der filter befindet sich im Fahrgastraum hinter dem Handshuhfach El filtro se encuentra en el habitáculo detrás de la guantera</p>	<p>09/00 -> </p>	<p>CK 9832-2 280 x 103 x 20</p>  <p><u>O/E numbers</u> Chevrolet/Daewoo 93740495 / 96331028 <u>Cross References</u> Fram CF9832-2 Mann..... Micronair..... Purflux..... Tecnocar..... Fiaam PC8145-2</p>	<p>---</p>
---	---------------------	---	------------

<p>--- Spark --- Mot.F8CV, B10S, LA2</p>  <p>Il filtro è posizionato nell'abitacolo dietro il vano portaoggetti The filter is located in the passenger compartment behind the glove compartment Le filtre est situé dans l'habitacle derrière la boîte à gants Der filter befindet sich im Fahrgastraum hinter dem Handshuhfach El filtro se encuentra en el habitáculo detrás de la guantera</p>	<p>05/05 -> 08/12 * </p>	<p>CK 2012 199 x 196 x 10</p>  <p><u>O/E numbers</u> Chevrolet/Daewoo 96425700 <u>Cross References</u> Fram CF11414 Mann CU2012 Micronair MP333 Purflux AH354 Tecnocar E647 Fiaam PC8322</p>	<p>---</p>
---	-----------------------------	---	------------

<p>--- Spark ---</p>  <p>Il filtro è posizionato nell'abitacolo dietro il vano portaoggetti The filter is located in the passenger compartment behind the glove compartment Le filtre est situé dans l'habitacle derrière la boîte à gants Der filter befindet sich im Fahrgastraum hinter dem Handshuhfach El filtro se encuentra en el habitáculo detrás de la guantera</p>	<p>03/10 -> * </p>	<p>CK 20010 215 x 200 x 20</p>  <p><u>O/E numbers</u> Chevrolet/Daewoo 95947238 <u>Cross References</u> Fram Mann CU20010 Micronair Purflux Tecnocar Fiaam</p>	<p>CK 20010-C 215 x 200 x 20</p>  <p><u>O/E numbers</u> Chevrolet/Daewoo 95215156 <u>Cross References</u> Fram CFA11739 Mann CUK20010 Micronair Purflux AHC409 Tecnocar EC700 Fiaam PCK8379</p>
---	-----------------------	---	---



<p>--- Trax ---</p>  <p>Il filtro è posizionato nell'abitacolo dietro il vano portaoggetti The filter is located in the passenger compartment behind the glove compartment Le filtre est situé dans l'habitacle derrière la boîte à gants Der filter befindet sich im Fahrgastraum hinter dem Handshuhfach El filtro se encuentra en el habitáculo detrás de la guantera</p>	<p>05/13 -> * </p>	<p>CK 10774 239 x 204 x 35</p>  <p><u>O/E numbers</u> Chevrolet/Daewoo 13271190 <u>Cross References</u> Fram CF10774 Mann CU2442 Micronair MP366 Purflux AH286 Tecnocar E603 Fiaam PC8255</p>	<p>CK 10774-C 239 x 204 x 35</p>  <p><u>O/E numbers</u> Chevrolet/Daewoo 13271191 <u>Cross References</u> Fram CFA10775 Mann CUK2442 Micronair MC866 Purflux AHC286 Tecnocar EC603 Fiaam PCK8255</p>
--	-----------------------	--	--



Anti-pollen

Activated carbon

CHEVROLET / DAEWOO



<p>--- Volt ---</p>  <ul style="list-style-type: none"> I Il filtro è posizionato nell'abitacolo dietro il vano portaoggetti GB The filter is located in the passenger compartment behind the glove compartment F Le filtre est situé dans l'habitacle derrière la boîte à gants D Der filter befindet sich im Fahrgastraum hinter dem Handshuhfach E El filtro se encuentra en el habitáculo detrás de la guantera 	<p>10/11 -> *</p>	<p>CK 10774 239 x 204 x 35</p>  <p><u>O/E numbers</u> Chevrolet/Daewoo 13271190</p> <p><u>Cross References</u> Fram CF10774 Mann CU2442 Micronair MP366 Purflux AH286 Tecnocar E603 Fiaam PC8255</p>	<p>CK 10774-C 239 x 204 x 35</p>  <p><u>O/E numbers</u> Chevrolet/Daewoo 13271191</p> <p><u>Cross References</u> Fram CFA10775 Mann CUK2442 Micronair MC866 Purflux AHC286 Tecnocar EC603 Fiaam PCK8255</p>





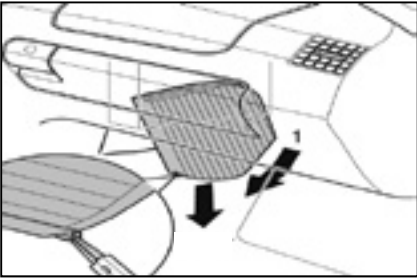

Anti-pollen

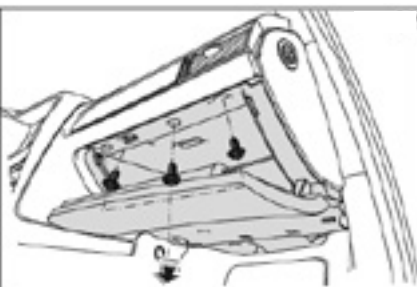

Activated carbon

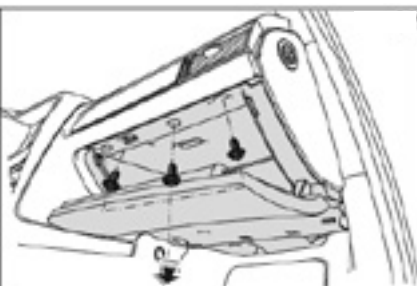

CHRYSLER

<p>--- Crossfire ---</p>  <p> I Il filtro è posizionato nell'abitacolo sotto il vano portaoggetti GB The filter is located in the passenger compartment under the glove compartment F Le filtre est situé dans l'habitacle en dessous de la boîte à gants D Der filter befindet sich im Fahrgastraum unter dem Handshuhfach E El filtro se encuentra en el habitáculo, bajo la guantera de pasajerruimte </p>	<p>09/03 -> 12/07 * <input type="checkbox"/></p>	<p>CK 5842 274/264 x 215/205 x35/53</p>  <p><u>O/E numbers</u> Chrysler 05101438AA / 05101439AA</p> <p><u>Cross References</u> Fram CF5842 Mann CU2897 Micronair MP005 Purflux AH138 Tecocar E337 Fiaam PC8016</p>	<p>CK 5842-C 278/262 x 216/206 x 54</p>  <p><u>O/E numbers</u> Chrysler.....</p> <p><u>Cross References</u> Fram CFA8877 Mann CUK2897 Micronair MC505 Purflux AHC138 Tecocar..... Fiaam PCK8065</p>
---	---	--	--

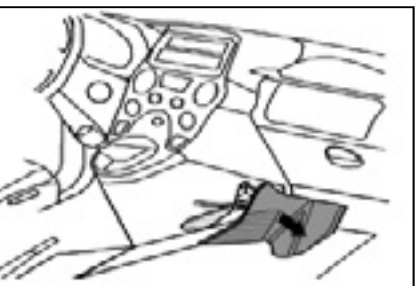
<p>--- Sebring ---</p>  <p> I Il filtro è posizionato nell'abitacolo sotto il vano portaoggetti GB The filter is located in the passenger compartment under the glove compartment F Le filtre est situé dans l'habitacle en dessous de la boîte à gants D Der filter befindet sich im Fahrgastraum unter dem Handshuhfach E El filtro se encuentra en el habitáculo, bajo la guantera de pasajerruimte </p>	<p>02/01 -> 12/10 * *</p>	<p>CK 2227 216 x 194 x 25</p>  <p><u>O/E numbers</u> Chrysler 05058693AA</p> <p><u>Cross References</u> Fram CF11444 Mann CU2227 Micronair MP325 Purflux AH365 Tecocar E659 Fiaam PC8335</p>	<p>CK 2227-C 216 x 194 x 25</p>  <p><u>O/E numbers</u> Chrysler 05058381AA</p> <p><u>Cross References</u> Fram Mann CUK2227 Micronair MC825 Purflux Tecocar Fiaam</p>
---	--	--	--

<p>--- Voyager / Grand Voyager (RT) ---</p>  <p> I Il filtro è posizionato nell'abitacolo sotto il vano portaoggetti GB The filter is located in the passenger compartment under the glove compartment F Le filtre est situé dans l'habitacle en dessous de la boîte à gants D Der filter befindet sich im Fahrgastraum unter dem Handshuhfach E El filtro se encuentra en el habitáculo, bajo la guantera de pasajerruimte </p>	<p>10/07 -> * *</p>	<p>CK 23003 230 x 200 x 30</p>  <p><u>O/E numbers</u> Fiat K68042866AA / K68127809AA</p> <p><u>Cross References</u> Fram CF11676 Mann CU23003 Micronair Purflux AH398 Tecocar E689 Fiaam PC8367</p>	<p>---</p>
--	----------------------------------	---	------------

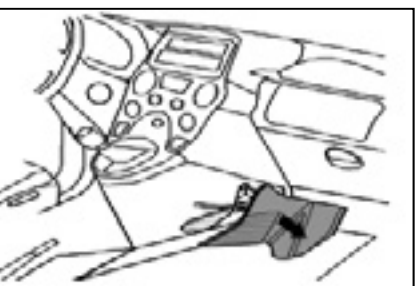
<p>--- Ypsilon ---</p>  <p> I Il filtro è posizionato nell'abitacolo sotto il vano portaoggetti GB The filter is located in the passenger compartment under the glove compartment F Le filtre est situé dans l'habitacle en dessous de la boîte à gants D Der filter befindet sich im Fahrgastraum unter dem Handshuhfach E El filtro se encuentra en el habitáculo, bajo la guantera de pasajerruimte </p>	<p>05/11 -> 08/11 * <input type="checkbox"/></p>	<p>CK 10025 202 x 176 x 18</p>  <p><u>O/E numbers</u> Fiat 46723321 / 77366065</p> <p><u>Cross References</u> Fram CF10025 Mann CU2026 Micronair MP163 Purflux AH233 Tecocar E432 Fiaam PC8159</p>	<p>CK 10025-C 202 x 176 x 18</p>  <p><u>O/E numbers</u> Fiat 77365763</p> <p><u>Cross References</u> Fram Mann CUK2026 Micronair MC663 Purflux Tecocar Fiaam</p>
---	---	--	---



<p>--- Ypsilon ---</p>  <p> I Il filtro è posizionato nell'abitacolo sotto il vano portaoggetti GB The filter is located in the passenger compartment under the glove compartment F Le filtre est situé dans l'habitacle en dessous de la boîte à gants D Der filter befindet sich im Fahrgastraum unter dem Handshuhfach E El filtro se encuentra en el habitáculo, bajo la guantera de pasajerruimte </p>	<p>09/11 -> * <input type="checkbox"/></p>	<p>CK 20006 194 x 188 x 30</p>  <p><u>O/E numbers</u> Fiat 51854923</p> <p><u>Cross References</u> Fram CF11470 Mann CU20006 Micronair MP412 Purflux AH371 Tecocar E665 Fiaam PC8340</p>	<p>CK 20006-C 194 x 188 x 30</p>  <p><u>O/E numbers</u> Fiat 71775823</p> <p><u>Cross References</u> Fram Mann CUK20006 Micronair Purflux Tecocar Fiaam</p>
---	---	--	--





Anti-pollen

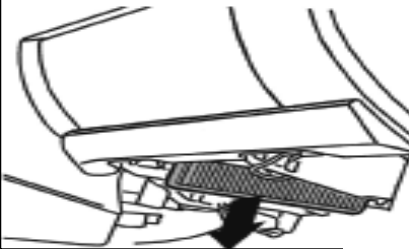

Activated carbon

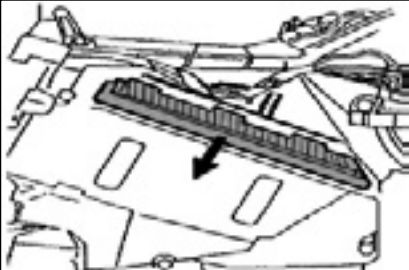

CITROEN

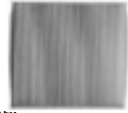
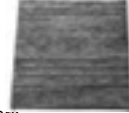
<p>--- Berlingo I (M49, M59) ---</p> <p>Manual AC</p> 	<p>09/96 -> 12/00</p> <p style="text-align: center;">*</p>	<p>CK 5551</p> <p>218/208 x 207/197 x 19</p>  <p><u>O/E numbers</u> Citroen 6447AK / 6447Z4 / 6447LV</p> <p><u>Cross References</u> Fram CF5551 Mann CU2225 Micronair MP034 Purflux AH101 Tecnocar E308 Fiaam PC8003</p>	
--	---	--	--

<p>--- Berlingo I (M49, M59) ---</p> 	<p>09/96 -> 12/00</p> <p style="text-align: center;">*</p>	<p>CK 8750</p> <p>266 x 201/191 x 19</p>  <p><u>O/E numbers</u> Citroen 6447FG</p> <p><u>Cross References</u> Fram CF8750 Mann CU2630 Micronair MP157 Purflux AH180 Tecnocar E383 Fiaam PC8049</p>	
---	---	--	--

<p>--- Berlingo I (M49, M59) ---</p> <p>Manual AC</p> 	<p>12/00 -> 03/10</p> <p style="text-align: center;">*</p>	<p>CK 9294</p> <p>220 x 225 x 35</p>  <p><u>O/E numbers</u> Citroen 6447HP / 663399D</p> <p><u>Cross References</u> Fram CF9294 Mann CU2245 Micronair MP173 Purflux AH193 Tecnocar E396 Fiaam PC8076</p>	<p>CK 9294-C</p> <p>220 x 225 x 35</p>  <p><u>O/E numbers</u> Citroen 6447SQ</p> <p><u>Cross References</u> Fram CFA9294 Mann CUK2245 Micronair MC673 Purflux AHC193 Tecnocar..... Fiaam PCK8076</p>
--	---	--	---

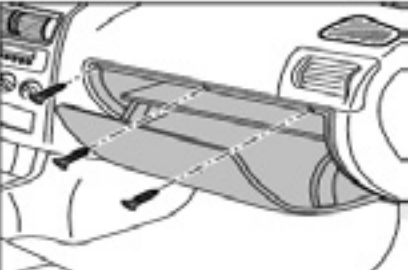
<p>--- Berlingo II (B9) ---</p> 	<p>04/08 -></p> <p style="text-align: center;">*</p>	<p>CK 10536-10-2</p> <p>291 x 97 x 30</p>  <p><u>O/E numbers</u> Citroen 6447XF</p> <p><u>Cross References</u> Fram CF10536-2 Mann CU3039-2 Micronair MP201-2 Purflux AH261 Tecnocar E475-2 Fiaam PC8218-2</p>	<p>CK 10536-10-C-2</p> <p>291 x 97 x 30</p>  <p><u>O/E numbers</u> Citroen 6447XG</p> <p><u>Cross References</u> Fram CFA10419-2 Mann CUK3039-2 Micronair MC701-2 Purflux AHC261 Tecnocar EC475-2 Fiaam PCK8204-2</p>
--	---	--	--

<p>--- C-Crosser ---</p> 	<p>09/07 -></p>	<p>CK 10431</p> <p>217 x 200 x 30</p>  <p><u>O/E numbers</u> Citroen 6447ZX</p> <p><u>Cross References</u> Fram CF10431 Mann CU2141 Micronair MP247 Purflux AH262 Tecnocar E472 Fiaam PC8201</p>	<p>CK 10431-C</p> <p>217 x 200 x 30</p>  <p><u>O/E numbers</u> Citroen.....</p> <p><u>Cross References</u> Fram CFA10431 Mann CUK2141 Micronair MC747 Purflux AHC262 Tecnocar EC472 Fiaam PCK8201</p>
---	--------------------	--	--



Anti-pollen

Activated carbon

CITROEN

--- C-Elysée ---

01/13 ->

*

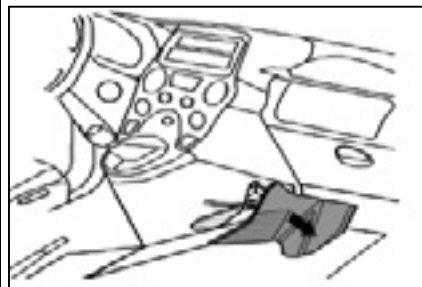

- I** Il filtro è posizionato nell'abitacolo sotto il vano portaoggetti
- GB** The filter is located in the passenger compartment under the glove compartment
- F** Le filtre est situé dans l'habitacle en dessous de la boîte à gants
- D** Der filter befindet sich im Fahrgastraum unter dem Handschuhfach
- E** El filtro se encuentra en el habitáculo, bajo la guanteraina de pasajerruimte

CK 921-2

240 x 84 x 20



O/E numbers

Citroen 9678792080

Cross References

Fram CF11745-2 Mann CU24012-2
 Micronair Purflux AH415-2
 Tecnocar E706-2 Fiaam PC8385-2

--- C1 ---

07/05 ->

*

*



- I** Il filtro è posizionato nell'abitacolo dietro il vano portaoggetti
- GB** The filter is located in the passenger compartment behind the glove compartment
- F** Le filtre est situé dans l'habitacle derrière la boîte à gants
- D** Der filter befindet sich im Fahrgastraum hinter dem Handschuhfach
- E** El filtro se encuentra en el habitáculo detrás de la guantera

CK 207

225/215 x 164/150,5 x 44



O/E numbers

Citroen 6447TV

Cross References

Fram CF10080 Mann CU2317
 Micronair MP207 Purflux AH223
 Tecnocar E440 Fiaam PC8243

--- C1 II (B4) ---

05/14 ->

*

*



- I** Il filtro è posizionato nell'abitacolo dietro il vano portaoggetti
- GB** The filter is located in the passenger compartment behind the glove compartment
- F** Le filtre est situé dans l'habitacle derrière la boîte à gants
- D** Der filter befindet sich im Fahrgastraum hinter dem Handschuhfach
- E** El filtro se encuentra en el habitáculo detrás de la guantera

CK 20013

194 x 145 x 30



O/E numbers

Citroen B000975480

Cross References

Fram Mann CU20013
 Micronair Purflux
 Tecnocar Fiaam

--- C2 ---

09/03 -> 05/10

*

*

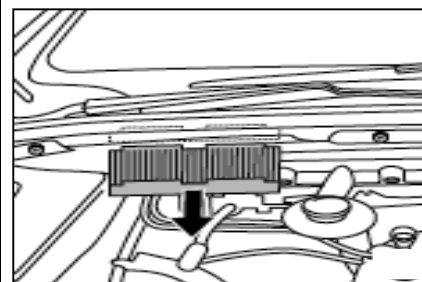

- I** Il filtro è posizionato nel vano motore sul lato passeggero
- GB** The filter is located in the engine compartment on the passenger's side
- F** Le filtre est situé dans le compartiment moteur du côté passager
- D** Der filter befindet sich Motorraum auf der Beifahrerseite
- E** El filtro se encuentra en el compartimiento del motor, del lado del acompañante

CK 9398

284 x 175 x 36



O/E numbers

Citroen 6447NT

Cross References

Fram CF9398 Mann CU2940
 Micronair MP071 Purflux AH179
 Tecnocar E382 Fiaam PC8088

CK 9398-C

284 x 175 x 36

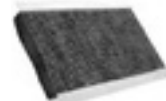

O/E numbers

Citroen 6447NV

Cross References

Fram CFA9587 Mann CUK2940
 Micronair MC571 Purflux AHC179
 Tecnocar EC382 Fiaam PCK8109

--- C3 / C3 Pluriel ---

02/02 -> 12/09

*

*

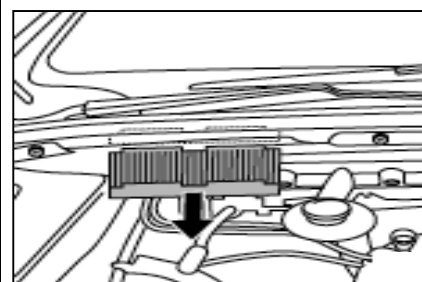

- I** Il filtro è posizionato nel vano motore sul lato passeggero
- GB** The filter is located in the engine compartment on the passenger's side
- F** Le filtre est situé dans le compartiment moteur du côté passager
- D** Der filter befindet sich Motorraum auf der Beifahrerseite
- E** El filtro se encuentra en el compartimiento del motor, del lado del acompañante

CK 9398

284 x 175 x 36



O/E numbers

Citroen 6447NT

Cross References

Fram CF9398 Mann CU2940
 Micronair MP071 Purflux AH179
 Tecnocar E382 Fiaam PC8088

CK 9398-C

284 x 175 x 36

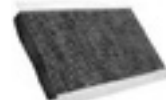

O/E numbers

Citroen 6447NV

Cross References

Fram CFA9587 Mann CUK2940
 Micronair MC571 Purflux AHC179
 Tecnocar EC382 Fiaam PCK8109



CITROEN

--- C3 II (A51) ---

11/09 -> * *

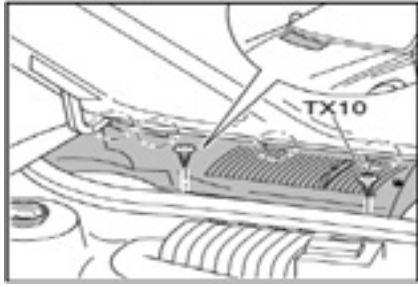

- I Il filtro è posizionato nel vano motore
- GB The filter is located in the engine compartment
- F Le filtre est situé dans le compartiment moteur
- D Der Filter befindet sich im Motorraum
- E El filtro se encuentra en el compartimiento del motor

CK 10205-2

203 x 158 x 31 / 153 x 158 x 31



O/E numbers

Citroen 6447VY

Cross References

Fram CF10204-2 Mann CU21000-2
 Micronair MP264-2 Purflux AH245
 Tecocar Fiaam PC8241-2

CK 10205-C-2

203 x 158 x 31 / 153 x 158 x 31



O/E numbers

Citroen 6447VX

Cross References

Fram CFA10205-2 Mann CUK21000-2
 Micronair MC764-2 Purflux AHC245
 Tecocar EC461-2 Fiaam PCK8173-2

--- C3 Picasso ---

02/09 -> * *

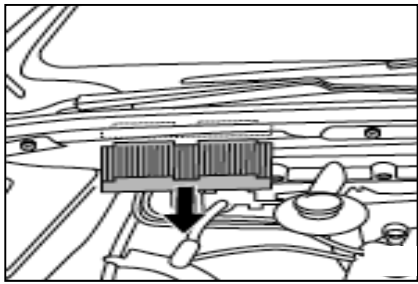

- I Il filtro è posizionato nel vano motore sul lato passeggero
- GB The filter is located in the engine compartment on the passenger's side
- F Le filtre est situé dans le compartiment moteur du côté passager
- D Der filter befindet sich Motorraum auf der Beifahrerseite
- E El filtro se encuentra en el compartimiento del motor, del lado del acompañante

CK 9398

284 x 175 x 36



O/E numbers

Citroen 6447NT

Cross References

Fram CF9398 Mann CU2940
 Micronair MP071 Purflux AH179
 Tecocar E382 Fiaam PC8088

CK 9398-C

284 x 175 x 36

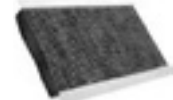

O/E numbers

Citroen 6447NV

Cross References

Fram CFA9587 Mann CUK2940
 Micronair MC571 Purflux AHC179
 Tecocar EC382 Fiaam PCK8109

--- C3 Pluriel ---

04/03 -> * *

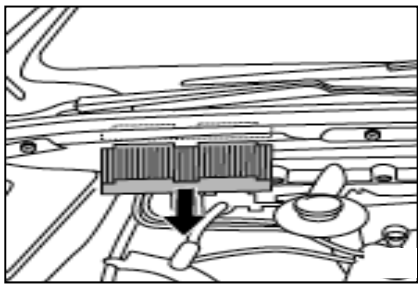

- I Il filtro è posizionato nel vano motore sul lato passeggero
- GB The filter is located in the engine compartment on the passenger's side
- F Le filtre est situé dans le compartiment moteur du côté passager
- D Der filter befindet sich Motorraum auf der Beifahrerseite
- E El filtro se encuentra en el compartimiento del motor, del lado del acompañante

CK 9398

284 x 175 x 36



O/E numbers

Citroen 6447NT

Cross References

Fram CF9398 Mann CU2940
 Micronair MP071 Purflux AH179
 Tecocar E382 Fiaam PC8088

CK 9398-C

284 x 175 x 36

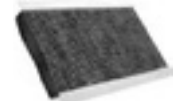

O/E numbers

Citroen 6447NV

Cross References

Fram CFA9587 Mann CUK2940
 Micronair MC571 Purflux AHC179
 Tecocar EC382 Fiaam PCK8109

--- C4 ---

10/04 -> 12/10 * *

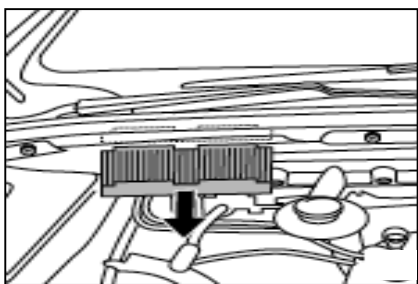

- I Il filtro è posizionato nel vano motore sul lato passeggero
- GB The filter is located in the engine compartment on the passenger's side
- F Le filtre est situé dans le compartiment moteur du côté passager
- D Der filter befindet sich Motorraum auf der Beifahrerseite
- E El filtro se encuentra en el compartimiento del motor, del lado del acompañante

CK 9398

284 x 175 x 36



O/E numbers

Citroen 6447NT

Cross References

Fram CF9398 Mann CU2940
 Micronair MP071 Purflux AH179
 Tecocar E382 Fiaam PC8088

CK 9398-C

284 x 175 x 36



O/E numbers

Citroen 6447NV

Cross References

Fram CFA9587 Mann CUK2940
 Micronair MC571 Purflux AHC179
 Tecocar EC382 Fiaam PCK8109

--- C4 II (B7) ---

10/10 -> * *

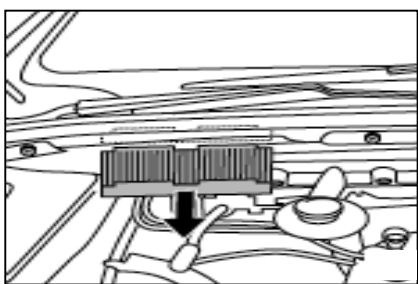

- I Il filtro è posizionato nel vano motore sul lato passeggero
- GB The filter is located in the engine compartment on the passenger's side
- F Le filtre est situé dans le compartiment moteur du côté passager
- D Der filter befindet sich Motorraum auf der Beifahrerseite
- E El filtro se encuentra en el compartimiento del motor, del lado del acompañante

CK 9398

284 x 175 x 36



O/E numbers

Citroen 6447NT

Cross References

Fram CF9398 Mann CU2940
 Micronair MP071 Purflux AH179
 Tecocar E382 Fiaam PC8088

CK 9398-C

284 x 175 x 36



O/E numbers

Citroen 6447NV

Cross References

Fram CFA9587 Mann CUK2940
 Micronair MC571 Purflux AHC179
 Tecocar EC382 Fiaam PCK8109



Anti-pollen

Activated carbon

CITROEN

--- C4 Aircross ---

04/12 ->

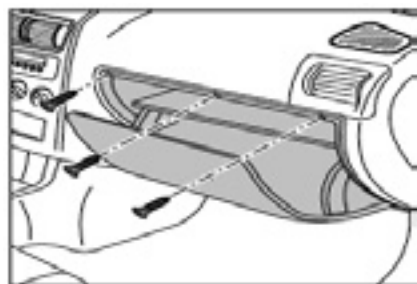

- I** Il filtro è posizionato nell'abitacolo dietro il vano portaoggetti
- GB** The filter is located in the passenger compartment behind the glove compartment
- F** Le filtre est situé dans l'habitacle derrière la boîte à gants
- D** Der filter befindet sich im Fahrgastraum hinter dem Handsuhfach
- E** El filtro se encuentra en el habitáculo detrás de la guantera

CK 10431

217 x 200 x 30



O/E numbers

Citroen 6447ZX

Cross References

Fram CF10431 Mann CU2141
Micronair MP247 Purflux AH262
Tecocar E472 Fiaam PC8201

CK 10431-C

217 x 200 x 30



O/E numbers

Citroen.....

Cross References

Fram CFA10431 Mann CUK2141
Micronair MC747 Purflux AHC262
Tecocar EC472 Fiaam PCK8201

--- C4 Cactus ---

05/14 -> *

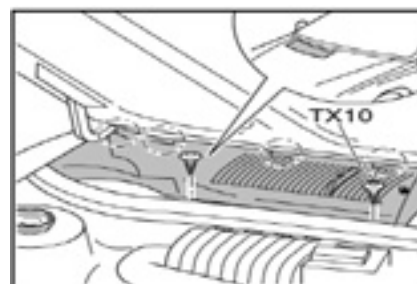

- I** Il filtro è posizionato nel vano motore
- GB** The filter is located in the engine compartment
- F** Le filtre est situé dans le compartiment moteur
- D** Der Filter befindet sich im Motorraum
- E** El filtro se encuentra en el compartimiento del motor

CK 10205-2

203 x 158 x 31 / 153 x 158 x 31



O/E numbers

Citroen 6447VY

Cross References

Fram CF10204-2 Mann CU21000-2
Micronair MP264-2 Purflux AH245
Tecocar Fiaam PC8241-2

CK 10205-C-2

203 x 158 x 31 / 153 x 158 x 31



O/E numbers

Citroen 6447VX

Cross References

Fram CFA10205-2 Mann CUK21000-2
Micronair MC764-2 Purflux AHC245
Tecocar EC461-2 Fiaam PCK8173-2

--- C4 Picasso ---

10/06 -> *

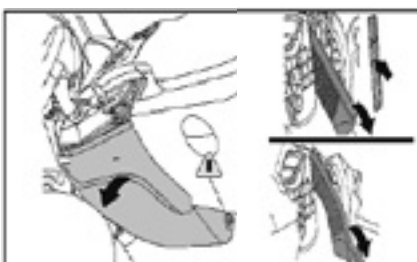

- I** Il filtro è posizionato nell'abitacolo dietro il vano portaoggetti
- GB** The filter is located in the passenger compartment behind the glove compartment
- F** Le filtre est situé dans l'habitacle derrière la boîte à gants
- D** Der filter befindet sich im Fahrgastraum hinter dem Handsuhfach
- E** El filtro se encuentra en el habitáculo detrás de la guantera

CK 10536-10-2

291 x 97 x 30



O/E numbers

Citroen 6447XF

Cross References

Fram CF10536-2 Mann CU3039-2
Micronair MP201-2 Purflux AH261
Tecocar E475-2 Fiaam PC8218-2

CK 10536-10-C-2

291 x 97 x 30



O/E numbers

Citroen 6447XG

Cross References

Fram CFA10419-2 Mann CUK3039-2
Micronair MC701-2 Purflux AHC261
Tecocar EC475-2 Fiaam PCK8204-2

--- C4 / Grand C4 Picasso II ---

06/13 -> *

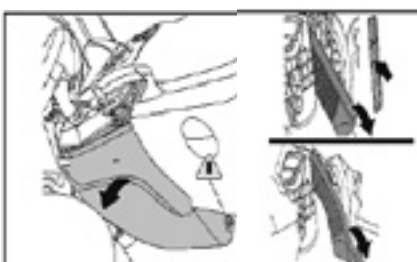

- I** Il filtro è posizionato nell'abitacolo dietro il vano portaoggetti
- GB** The filter is located in the passenger compartment behind the glove compartment
- F** Le filtre est situé dans l'habitacle derrière la boîte à gants
- D** Der filter befindet sich im Fahrgastraum hinter dem Handsuhfach
- E** El filtro se encuentra en el habitáculo detrás de la guantera

CK 10536-10-2

291 x 97 x 30



O/E numbers

Citroen 6447XF

Cross References

Fram CF10536-2 Mann CU3039-2
Micronair MP201-2 Purflux AH261
Tecocar E475-2 Fiaam PC8218-2

CK 10536-10-C-2

291 x 97 x 30



O/E numbers

Citroen 6447XG

Cross References

Fram CFA10419-2 Mann CUK3039-2
Micronair MC701-2 Purflux AHC261
Tecocar EC475-2 Fiaam PCK8204-2

--- C4 Sedan ---

04/13 -> *

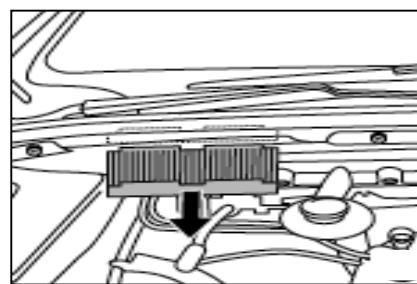

- I** Il filtro è posizionato nel vano motore sul lato passeggero
- GB** The filter is located in the engine compartment on the passenger's side
- F** Le filtre est situé dans le compartiment moteur du côté passager
- D** Der filter befindet sich im Motorraum auf der Beifahrerseite
- E** El filtro se encuentra en el compartimiento del motor, del lado del acompañante

CK 9398

284 x 175 x 36



O/E numbers

Citroen 6447NT

Cross References

Fram CF9398 Mann CU2940
Micronair MP071 Purflux AH179
Tecocar E382 Fiaam PC8088

CK 9398-C

284 x 175 x 36

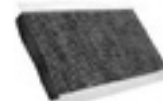

O/E numbers

Citroen 6447NV

Cross References

Fram CFA9587 Mann CUK2940
Micronair MC571 Purflux AHC179
Tecocar EC382 Fiaam PCK8109



Anti-pollen

Activated carbon

CITROEN

<p>--- C5 ---</p>	<p>03/01 -> 09/04</p> <p>*</p>	<p>CK 9562 345/324 x 166/160 x 35/75</p> <p><u>O/E numbers</u> Citroen 6447HT</p> <p><u>Cross References</u> Fram CF9562 Mann CU3518 Micronair MP188 Puflux..... Tecnocar..... Fiaam PC8110</p>	<p>CK 9562-C 345/324 x 166/160 x 35/75</p> <p><u>O/E numbers</u> Citroen 6447HV</p> <p><u>Cross References</u> Fram CFA9562 Mann CUK3518 Micronair MC688 Puflux AHC183 Tecnocar EC386 Fiaam PCK8110</p>
	<p>I Il filtro è posizionato nell'abitacolo sul lato conducente</p> <p>GB The filter is located in the passenger compartment on the driver's side</p> <p>F Le filtre est situé dans l'habitacle du côté conducteur</p> <p>D Der Filter befindet sich im Fahrgastraum auf der Fahrerseite</p> <p>E El Filtro se encuentra en el habitáculo, del lado del conductor</p>		

<p>--- C5 --- Automatic AC</p>	<p>10/04 -> 05/08</p> <p>*</p>	<p>---</p>	<p>CK 9920-C 315 x 152 x 40</p> <p><u>O/E numbers</u> Citroen 6447TC</p> <p><u>Cross References</u> Fram CFA9920 Mann CUK3240 Micronair MC640 Puflux AHC213 Tecnocar EC417 Fiaam PCK8153</p>
	<p>I Il filtro è posizionato nell'abitacolo sul lato conducente</p> <p>GB The filter is located in the passenger compartment on the driver's side</p> <p>F Le filtre est situé dans l'habitacle du côté conducteur</p> <p>D Der Filter befindet sich im Fahrgastraum auf der Fahrerseite</p> <p>E El Filtro se encuentra en el habitáculo, del lado del conductor</p>		

<p>--- C5 II ---</p>	<p>04/08 -></p> <p>*</p>	<p>CK 10529 270 x 196 x 32</p> <p><u>O/E numbers</u> Citroen</p> <p><u>Cross References</u> Fram Mann Micronair MP367 Puflux Tecnocar Fiaam</p>	<p>CK 10529-C 270 x 196 x 32</p> <p><u>O/E numbers</u> Citroen 647945</p> <p><u>Cross References</u> Fram CFA10529 Mann CUK2742 Micronair MC867 Puflux AHC272 Tecnocar Fiaam PCK8216</p>
	<p>I Il filtro è posizionato nell'abitacolo sul lato conducente</p> <p>GB The filter is located in the passenger compartment on the driver's side</p> <p>F Le filtre est situé dans l'habitacle du côté conducteur</p> <p>D Der Filter befindet sich im Fahrgastraum auf der Fahrerseite</p> <p>E El Filtro se encuentra en el habitáculo, del lado del conductor</p>		

<p>--- C6 --- -> Chassis ORGA 11556 VISTEON air conditioning</p>	<p>10/05 -> 06/08</p> <p>*</p>	<p>---</p>	<p>CK 9920-C 315 x 152 x 40</p> <p><u>O/E numbers</u> Citroen 6447TC</p> <p><u>Cross References</u> Fram CFA9920 Mann CUK3240 Micronair MC640 Puflux AHC213 Tecnocar EC417 Fiaam PCK8153</p>
	<p>I Il filtro è posizionato nell'abitacolo sul lato conducente</p> <p>GB The filter is located in the passenger compartment on the driver's side</p> <p>F Le filtre est situé dans l'habitacle du côté conducteur</p> <p>D Der Filter befindet sich im Fahrgastraum auf der Fahrerseite</p> <p>E El Filtro se encuentra en el habitáculo, del lado del conductor</p>		









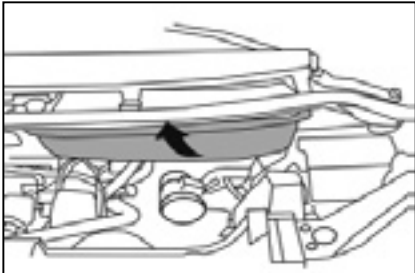

<p>--- C6 --- Chassis ORGA 11557 -> BEHR air conditioning</p>	<p>07/08 -></p> <p>*</p>	<p>CK 10529 270 x 196 x 32</p> <p><u>O/E numbers</u> Citroen</p> <p><u>Cross References</u> Fram Mann Micronair MP367 Puflux Tecnocar Fiaam</p>	<p>CK 10529-C 270 x 196 x 32</p> <p><u>O/E numbers</u> Citroen 647945</p> <p><u>Cross References</u> Fram CFA10529 Mann CUK2742 Micronair MC867 Puflux AHC272 Tecnocar Fiaam PCK8216</p>
	<p>I Il filtro è posizionato nell'abitacolo sul lato conducente</p> <p>GB The filter is located in the passenger compartment on the driver's side</p> <p>F Le filtre est situé dans l'habitacle du côté conducteur</p> <p>D Der Filter befindet sich im Fahrgastraum auf der Fahrerseite</p> <p>E El Filtro se encuentra en el habitáculo, del lado del conductor</p>		

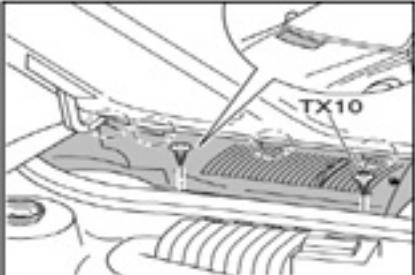

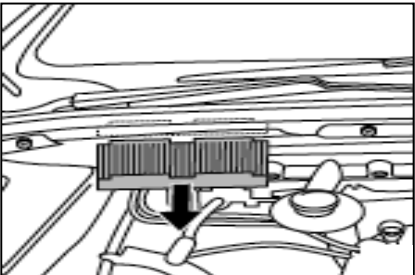
Anti-pollen

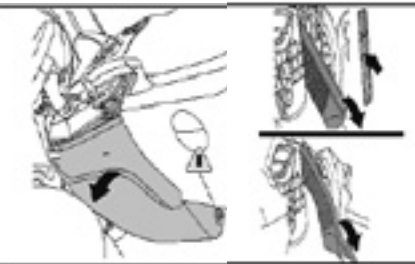
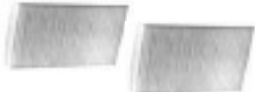
Activated carbon

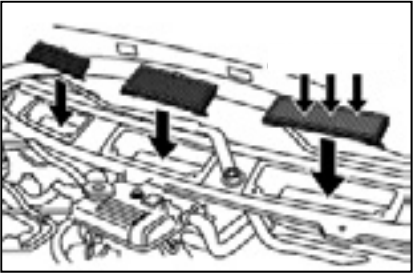
CITROEN

<p>--- C8 ---</p> 	<p>07/02 -> * <input type="checkbox"/></p> <p> I Il filtro è posizionato nel vano motore sul lato passeggero GB The filter is located in the engine compartment on the passenger's side F Le filtre est situé dans le compartiment moteur du côté passager D Der filter befindet sich Motorraum auf der Beifahrerseite E El filtro se encuentra en el compartimiento del motor, del lado del acompañante </p>	<p>CK 9586 405 x 164 x 32</p>  <p><u>O/E numbers</u> Citroen 6447LZ <u>Cross References</u> Fram CF9586 Mann CU4179 Micronair MP116 Purlux AH205 Tecocar E408 Fiaam PC8108</p>	<p>CK 9586-C 405 x 164 x 32</p>  <p><u>O/E numbers</u> Citroen 6447SP <u>Cross References</u> Fram CFA10307 Mann CUK4179 Micronair MC616 Purlux AHC205 Tecocar EC408 Fiaam PCK8190</p>
<p>--- DS 3 ---</p> 	<p>03/10 -> * <input type="checkbox"/> * <input type="checkbox"/></p> <p> I Il filtro è posizionato nel vano motore GB The filter is located in the engine compartment F Le filtre est situé dans le compartiment moteur D Der Filter befindet sich im Motorraum E El filtro se encuentra en el compartimiento del motor </p>	<p>CK 10205-2 203 x 158 x 31 / 153 x 158 x 31</p>  <p><u>O/E numbers</u> Citroen 6447VY <u>Cross References</u> Fram CF10204-2 Mann CU21000-2 Micronair MP264-2 Purlux AH245 Tecocar Fiaam PC8241-2</p>	<p>CK 10205-C-2 203 x 158 x 31 / 153 x 158 x 31</p>  <p><u>O/E numbers</u> Citroen 6447VX <u>Cross References</u> Fram CFA10205-2 Mann CUK21000-2 Micronair MC764-2 Purlux AHC245 Tecocar EC461-2 Fiaam PCK8173-2</p>
<p>--- DS 4 ---</p> 	<p>05/11 -> * <input type="checkbox"/> * <input type="checkbox"/></p> <p> I Il filtro è posizionato nel vano motore sul lato passeggero GB The filter is located in the engine compartment on the passenger's side F Le filtre est situé dans le compartiment moteur du côté passager D Der filter befindet sich Motorraum auf der Beifahrerseite E El filtro se encuentra en el compartimiento del motor, del lado del acompañante </p>	<p>CK 9398 284 x 175 x 36</p>  <p><u>O/E numbers</u> Citroen 6447NT <u>Cross References</u> Fram CF9398 Mann CU2940 Micronair MP071 Purlux AH179 Tecocar E382 Fiaam PC8088</p>	<p>CK 9398-C 284 x 175 x 36</p>  <p><u>O/E numbers</u> Citroen 6447NV <u>Cross References</u> Fram CFA9587 Mann CUK2940 Micronair MC571 Purlux AHC179 Tecocar EC382 Fiaam PCK8109</p>
<p>--- DS 5 ---</p> 	<p>10/11 -> * <input type="checkbox"/></p> <p> I Il filtro è posizionato nell'abitacolo dietro il vano portaoggetti GB The filter is located in the passenger compartment behind the glove compartment F Le filtre est situé dans l'habitacle derrière la boîte à gants D Der filter befindet sich im Fahrgastraum hinter dem Handschuhfach E El filtro se encuentra en el habitáculo detrás de la guantera </p>	<p>CK 10536-10-2 291 x 97 x 30</p>  <p><u>O/E numbers</u> Citroen 6447XF <u>Cross References</u> Fram CF10536-2 Mann CU3039-2 Micronair MP201-2 Purlux AH261 Tecocar E475-2 Fiaam PC8218-2</p>	<p>CK 10536-10-C-2 291 x 97 x 30</p>  <p><u>O/E numbers</u> Citroen 6447XG <u>Cross References</u> Fram CFA10419-2 Mann CUK3039-2 Micronair MC701-2 Purlux AHC261 Tecocar EC475-2 Fiaam PCK8204-2</p>
<p>--- Evasion (Synergie) ---</p> 	<p>06/94 -> 07/02 * <input type="checkbox"/></p> <p> I Il filtro è posizionato nel vano motore sul lato passeggero GB The filter is located in the engine compartment on the passenger's side F Le filtre est situé dans le compartiment moteur du côté passager D Der filter befindet sich Motorraum auf der Beifahrerseite E El filtro se encuentra en el compartimiento del motor, del lado del acompañante </p>	<p>CK 8947-3 1) 194 x 94/86 x 33 2) 194 x 67/64 x 33</p>  <p><u>O/E numbers</u> Citroen 6447H0 / 6447H1 / KN41079 <u>Cross References</u> Fram CF8947/CF8948 Mann CU19000-3 Micronair MP087-3 Purlux AH112/AH113 Tecocar E315/E316 Fiaam PC8055/PC8056</p>	<p>---</p>



Anti-pollen

Activated carbon

CITROEN

--- Jumper I + II (Relay I + II) ---

02/94 -> 06/06

*

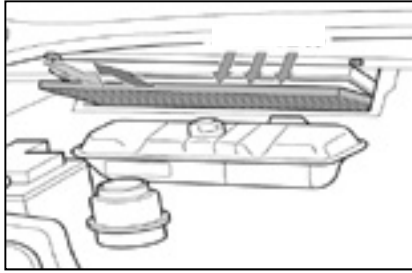

- I Il filtro è posizionato nel vano motore sul lato passeggero
- GB The filter is located in the engine compartment on the passenger's side
- F Le filtre est situé dans le compartiment moteur du côté passager
- D Der filter befindet sich Motorraum auf der Beifahrerseite
- E El filtro se encuentra en el compartimiento del motor, del lado del acompañante

CK 8890

435 x 144,5 x 17



O/E numbers

Citroen 6447J0

Cross References

Fram CF8890 Mann CU4442
Micronair MP013 Puflux AH231
Tecocar E430 Fiaam PC8051

--- Jumper III (Relay III) ---

06/06 ->

*

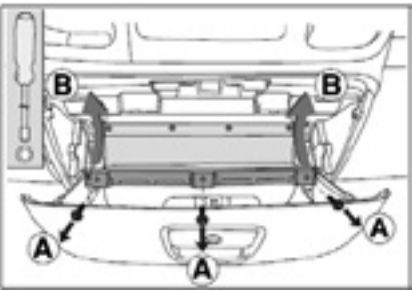

- I Il filtro è posizionato nell'abitacolo dietro il vano portaoggetti
- GB The filter is located in the passenger compartment behind the glove compartment
- F Le filtre est situé dans l'habitacle derrière la boîte à gants
- D Der filter befindet sich im Fahrgastraum hinter dem Handshuhfach
- E El filtro se encuentra en el habitáculo detrás de la guantera

CK 2544

250 x 234 x 25



O/E numbers

Citroen 6447YC

Cross References

Fram CF10420 Mann CU2544
Micronair MP262 Puflux AH263
Tecocar E476 Fiaam PC8205

--- Jumpy I ---

06/94 -> 03/04

*

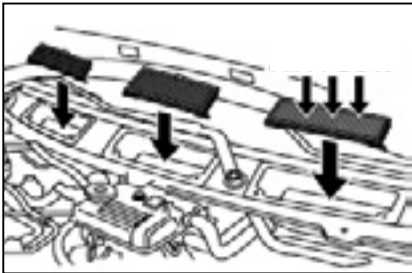

- I Il filtro è posizionato nel vano motore sul lato passeggero
- GB The filter is located in the engine compartment on the passenger's side
- F Le filtre est situé dans le compartiment moteur du côté passager
- D Der filter befindet sich Motorraum auf der Beifahrerseite
- E El filtro se encuentra en el compartimiento del motor, del lado del acompañante

CK 8947-3

- 1) 194 x 94/86 x 33
- 2) 194 x 67/64 x 33

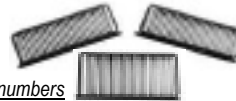

O/E numbers

Citroen 6447H0 / 6447H1 / KN41079

Cross References

Fram CF8947/CF8948 Mann CU19000-3
Micronair MP087-3 Puflux AH112/AH113
Tecocar E315/E316 Fiaam PC8055/PC8056

--- Jumpy I ---

04/04 -> 01/07

*

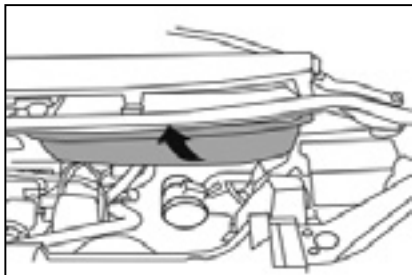

- I Il filtro è posizionato nel vano motore sul lato passeggero
- GB The filter is located in the engine compartment on the passenger's side
- F Le filtre est situé dans le compartiment moteur du côté passager
- D Der filter befindet sich Motorraum auf der Beifahrerseite
- E El filtro se encuentra en el compartimiento del motor, del lado del acompañante

CK 9586

405 x 164 x 32



O/E numbers

Citroen 6447LZ

Cross References

Fram CF9586 Mann CU4179
Micronair MP116 Puflux AH205
Tecocar E408 Fiaam PC8108

CK 9586-C

405 x 164 x 32



O/E numbers

Citroen 6447SP

Cross References

Fram CFA10307 Mann CUK4179
Micronair MC616 Puflux AHC205
Tecocar EC408 Fiaam PCK8190

--- Jumpy II ---

01/07 ->

*

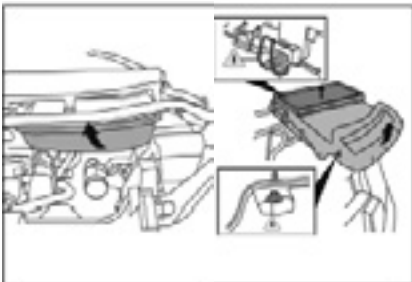

- I Il filtro è posizionato nel vano motore
- GB The filter is located in the engine compartment
- F Le filtre est situé dans le compartiment moteur
- D Der Filter befindet sich im Motorraum
- E El filtro se encuentra en el compartimiento del motor

CK 10366-10

375 x 175 x 48



O/E numbers

Citroen 6447YK

Cross References

Fram Mann CU3847
Micronair MP300 Puflux
Tecocar Fiaam

CK 10366-10-C

375 x 175 x 48



O/E numbers

Citroen 6447YN

Cross References



Fram CFA10366 Mann CUK3847
Micronair MC800 Puflux AHC258
Tecocar EC464 Fiaam PCK8193





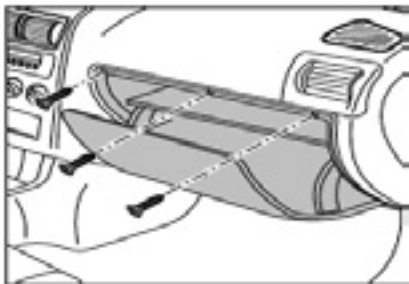

Anti-pollen

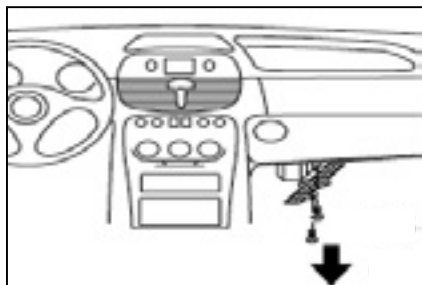

Activated carbon

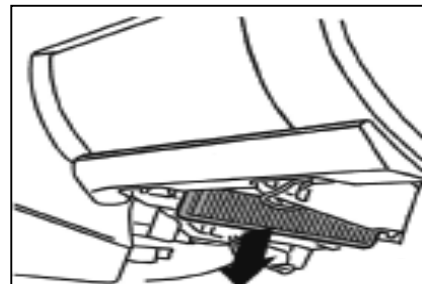

CITROEN

<p>--- Nemo --- Left-hand drive</p>  <p>Il filtro è posizionato nell'abitacolo dietro il vano portaoggetti The filter is located in the passenger compartment behind the glove compartment Le filtre est situé dans l'habitacle derrière la boîte à gants Der filter befindet sich im Fahrgastraum hinter dem Handshuhfach El filtro se encuentra en el habitáculo detrás de la guantera</p>	<p>02/08 -> * </p>	<p>CK 10413-10 199 x 177,5 x 30</p>  <p><u>O/E numbers</u> Citroen 647962 <u>Cross References</u> Fram CF10413 Mann CU2040 Micronair MP283 Purflux AH265 Tecnocar Fiaam PC8200</p>	
--	-----------------------	---	--

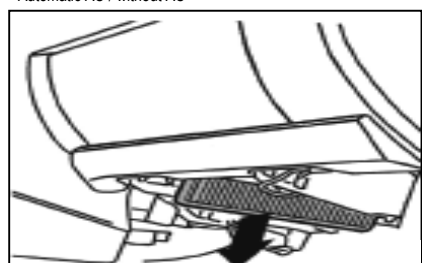
<p>--- Nemo --- Right-hand drive</p>  <p>Il filtro è posizionato nell'abitacolo dietro il vano portaoggetti The filter is located in the passenger compartment behind the glove compartment Le filtre est situé dans l'habitacle derrière la boîte à gants Der filter befindet sich im Fahrgastraum hinter dem Handshuhfach El filtro se encuentra en el habitáculo detrás de la guantera</p>	<p>02/08 -> * </p>	<p>CK 2243 265 x 217 x 20,5</p>  <p><u>O/E numbers</u> Citroen 647960 <u>Cross References</u> Fram CF10282 Mann CU2243 Micronair MP193 Purflux AH244 Tecnocar E465 Fiaam PC8170</p>	<p>CK 2243-C 265 x 217 x 20,5</p>  <p><u>O/E numbers</u> Citroen..... <u>Cross References</u> Fram CFA10365 Mann CUK2243 Micronair MC693 Purflux AHC244 Tecnocar EC465 Fiaam PCK8194</p>
---	-----------------------	--	--

<p>--- Xantia ---</p>  <p>Il filtro è posizionato nell'abitacolo sotto il vano portaoggetti The filter is located in the passenger compartment under the glove compartment Le filtre est situé dans l'habitacle en dessous de la boîte à gants Der filter befindet sich im Fahrgastraum unter dem Handshuhfach El filtro se encuentra en el habitáculo, bajo la guantera in de passagieruimte</p>	<p>03/93 -> 01/98 * </p>	<p>CK 5551 218/208 x 207/197 x 19</p>  <p><u>O/E numbers</u> Citroen 6447AK / 6447Z4 / 6447LV <u>Cross References</u> Fram CF5551 Mann CU2225 Micronair MP034 Purflux AH101 Tecnocar E308 Fiaam PC8003</p>	
---	-----------------------------	---	--

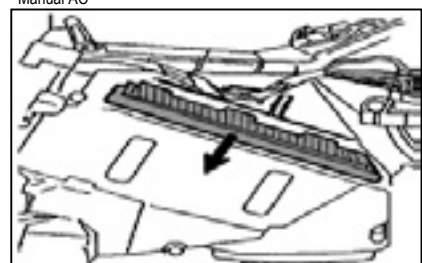
<p>--- Xsara --- Automatic AC / without AC</p>  <p>Il filtro è posizionato nell'abitacolo sotto il vano portaoggetti The filter is located in the passenger compartment under the glove compartment Le filtre est situé dans l'habitacle en dessous de la boîte à gants Der filter befindet sich im Fahrgastraum unter dem Handshuhfach El filtro se encuentra en el habitáculo, bajo la guantera in de passagieruimte</p>	<p>09/97 -> 08/00 * * </p>	<p>CK 5551 207/197 x 218/208 x 19</p>  <p><u>O/E numbers</u> Citroen 6447AK / 6447Z4 / 6447LV <u>Cross References</u> Fram CF5551 Mann CU2225 Micronair MP034 Purflux AH101 Tecnocar E308 Fiaam PC8003</p>	
--	-------------------------------	---	--

<p>--- Xsara --- Manual AC</p>  <p>Il filtro è posizionato nell'abitacolo sotto il vano portaoggetti The filter is located in the passenger compartment under the glove compartment Le filtre est situé dans l'habitacle en dessous de la boîte à gants Der filter befindet sich im Fahrgastraum unter dem Handshuhfach El filtro se encuentra en el habitáculo, bajo la guantera in de passagieruimte</p>	<p>09/97 -> 08/00 * </p>	<p>CK 8750 266 x 201/191 x 19</p>  <p><u>O/E numbers</u> Citroen 6447FG <u>Cross References</u> Fram CF8750 Mann CU2630 Micronair MP157 Purflux AH180 Tecnocar E383 Fiaam PC8049</p>	
--	-----------------------------	---	--



Anti-pollen

Activated carbon

CITROEN

--- Xsara ---

09/00 -> *

Automatic AC

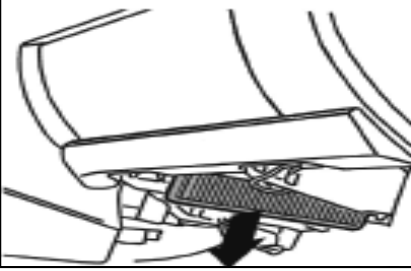

- I** Il filtro è posizionato nell'abitacolo sotto il vano portaoggetti
- GB** The filter is located in the passenger compartment under the glove compartment
- F** Le filtre est situé dans l'habitacle en dessous de la boîte à gants
- D** Der filter befindet sich im Fahrgastraum unter dem Handschuhfach
- E** El filtro se encuentra en el habitáculo, bajo la guantera de pasajerruimte

CK 9294

220 x 225 x 35



O/E numbers

Citroen 6447HP / 663399D

Cross References

Fram CF9294 Mann CU2245
 Micronair MP173 Purflux AH193
 Tecnocar E396 Fiaam PC8076

CK 9294-C

220 x 225 x 35



O/E numbers

Citroen 6447SQ

Cross References

Fram CFA9294 Mann CUK2245
 Micronair MC673 Purflux AHC193
 Tecnocar..... Fiaam PCK8076

--- Xsara ---

09/00 -> *

Manual AC

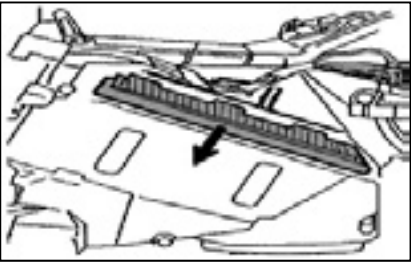

- I** Il filtro è posizionato nell'abitacolo sotto il vano portaoggetti
- GB** The filter is located in the passenger compartment under the glove compartment
- F** Le filtre est situé dans l'habitacle en dessous de la boîte à gants
- D** Der filter befindet sich im Fahrgastraum unter dem Handschuhfach
- E** El filtro se encuentra en el habitáculo, bajo la guantera de pasajerruimte

CK 8750

266 x 201/191 x 19



O/E numbers

Citroen 6447FG

Cross References

Fram CF8750 Mann CU2630
 Micronair MP157 Purflux AH180
 Tecnocar E383 Fiaam PC8049

--- Xsara ---

09/00 -> *

Without AC

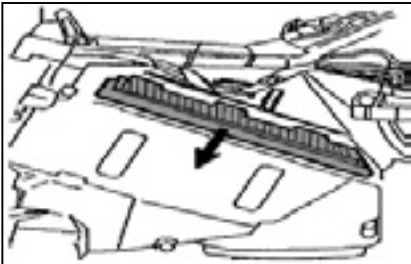

- I** Il filtro è posizionato nell'abitacolo sotto il vano portaoggetti
- GB** The filter is located in the passenger compartment under the glove compartment
- F** Le filtre est situé dans l'habitacle en dessous de la boîte à gants
- D** Der filter befindet sich im Fahrgastraum unter dem Handschuhfach
- E** El filtro se encuentra en el habitáculo, bajo la guantera de pasajerruimte

CK 5551

207/197 x 218/208 x 19



O/E numbers

Citroen 6447AK / 6447Z4 / 6447LV

Cross References

Fram CF5551 Mann CU2225
 Micronair MP034 Purflux AH101
 Tecnocar E308 Fiaam PC8003

--- Xsara Picasso ---

11/99 -> * *

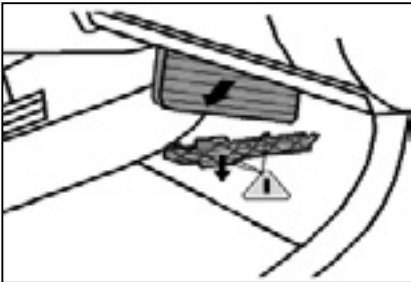

- I** Il filtro è posizionato nel vano motore sul lato passeggero
- GB** The filter is located in the engine compartment on the passenger's side
- F** Le filtre est situé dans le compartiment moteur du côté passager
- D** Der filter befindet sich Motorraum auf der Beifahrerseite
- E** El filtro se encuentra en el compartimiento del motor, del lado del acompañante

CK 9406

254 x 200 x 30



O/E numbers

Citroen 6447FF

Cross References

Fram CF9406 Mann CU2680
 Micronair MP061 Purflux AH166
 Tecnocar E372 Fiaam PC8091

CK 9406-C

254 x 200 x 30



O/E numbers

Citroen 6447LN

Cross References

Fram CFA9406 Mann CUK2680
 Micronair MC561 Purflux AHC166
 Tecnocar..... Fiaam PCK8091



Anti-pollen

Activated carbon

DACIA

<p>--- Dokker ---</p> <p>Il filtro è posizionato nell'abitacolo sotto il vano portaoggetti The filter is located in the passenger compartment under the glove compartment Le filtre est situé dans l'habitacle en dessous de la boîte à gants Der filter befindet sich im Fahrgastraum unter dem Handschuhfach El filtro se encuentra en el habitáculo, bajo la guantera de pasajerruimte</p>	07/12 ->	*		<p>CK 25012 249 x 180 x 35</p> <p><u>O/E numbers</u> Renault 272775340R</p> <p><u>Cross References</u> Fram CF11544 Mann CU25012 Micronair MP427 Purflux AH386 Tecocar E678 Fiaam PC8355</p>	<p>CK 25012-C 249 x 180 x 35</p> <p><u>O/E numbers</u> Renault 272775081R</p> <p><u>Cross References</u> Fram CFA11544 Mann CUK25012 Micronair MC927 Purflux AHC386 Tecocar EC678 Fiaam PCK8355</p>
---	----------	---	--	--	---

<p>--- Duster II ---</p> <p>Il filtro è posizionato nell'abitacolo sotto il vano portaoggetti The filter is located in the passenger compartment under the glove compartment Le filtre est situé dans l'habitacle en dessous de la boîte à gants Der filter befindet sich im Fahrgastraum unter dem Handschuhfach El filtro se encuentra en el habitáculo, bajo la guantera de pasajerruimte</p>	04/10 ->	*		<p>CK 9691 205 x 181,5 x 27,5/42</p> <p><u>O/E numbers</u> Dacia 272772835R</p> <p><u>Cross References</u> Fram CF9691 Mann CU1829 Micronair MP179 Purflux AH207 Tecocar E411 Fiaam PC8128</p>	
--	----------	---	--	--	--

<p>--- Lodgy ---</p> <p>Il filtro è posizionato nell'abitacolo sotto il vano portaoggetti The filter is located in the passenger compartment under the glove compartment Le filtre est situé dans l'habitacle en dessous de la boîte à gants Der filter befindet sich im Fahrgastraum unter dem Handschuhfach El filtro se encuentra en el habitáculo, bajo la guantera de pasajerruimte</p>	03/12 ->	*		<p>CK 25012 249 x 180 x 35</p> <p><u>O/E numbers</u> Renault 272775340R</p> <p><u>Cross References</u> Fram CF11544 Mann CU25012 Micronair MP427 Purflux AH386 Tecocar E678 Fiaam PC8355</p>	<p>CK 25012-C 249 x 180 x 35</p> <p><u>O/E numbers</u> Renault 272775081R</p> <p><u>Cross References</u> Fram CFA11544 Mann CUK25012 Micronair MC927 Purflux AHC386 Tecocar EC678 Fiaam PCK8355</p>
--	----------	---	--	--	---

<p>--- Logan / Logan Express ---</p> <p>Il filtro è posizionato nell'abitacolo sotto il vano portaoggetti The filter is located in the passenger compartment under the glove compartment Le filtre est situé dans l'habitacle en dessous de la boîte à gants Der filter befindet sich im Fahrgastraum unter dem Handschuhfach El filtro se encuentra en el habitáculo, bajo la guantera de pasajerruimte</p>	09/04 ->	*		<p>CK 9691 205 x 181,5 x 27,5/42</p> <p><u>O/E numbers</u> Dacia 272772835R</p> <p><u>Cross References</u> Fram CF9691 Mann CU1829 Micronair MP179 Purflux AH207 Tecocar E411 Fiaam PC8128</p>	
--	----------	---	--	--	--

<p>--- Logan II ---</p> <p>Il filtro è posizionato nell'abitacolo sotto il vano portaoggetti The filter is located in the passenger compartment under the glove compartment Le filtre est situé dans l'habitacle en dessous de la boîte à gants Der filter befindet sich im Fahrgastraum unter dem Handschuhfach El filtro se encuentra en el habitáculo, bajo la guantera de pasajerruimte</p>	05/13 ->	*		<p>CK 22011 216 x 200 x 35</p> <p><u>O/E numbers</u> Dacia 272773016R / 272778214R</p> <p><u>Cross References</u> Fram CF11706 Mann CU22011 Micronair MP428 Purflux AH405 Tecocar E626 Fiaam PC8374</p>	<p>CK 22011-C 216 x 200 x 35</p> <p><u>O/E numbers</u> Dacia 272770567R / 272779683R</p> <p><u>Cross References</u> Fram CFA11706 Mann CUK22011 Micronair Purflux AHC405 Tecocar EC696 Fiaam PCK8374</p>
---	----------	---	--	---	--





Anti-pollen

Activated carbon

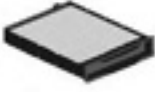
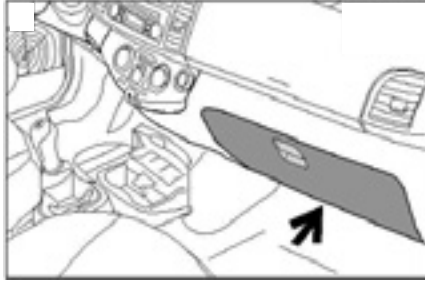
DACIA

<p>--- Sandero / Sandero Stepway ---</p>	<p>05/08 -></p>	<p>*</p>		<p>CK 9691 205 x 181,5 x 27,5/42</p>  <p><u>O/E numbers</u> Dacia 272772835R</p> <p><u>Cross References</u> Fram CF9691 Mann CU1829 Micronair MP179 Purflux AH207 Tecnocar E411 Fiaam PC8128</p>	
 <p>I Il filtro è posizionato nell'abitacolo sotto il vano portaoggetti</p> <p>GB The filter is located in the passenger compartment under the glove compartment</p> <p>F Le filtre est situé dans l'habitacle en dessous de la boîte à gants</p> <p>D Der filter befindet sich im Fahrgastraum unter dem Handshuhfach</p> <p>E El filtro se encuentra en el habitáculo, bajo la guanterain de pasajerruimte</p>					

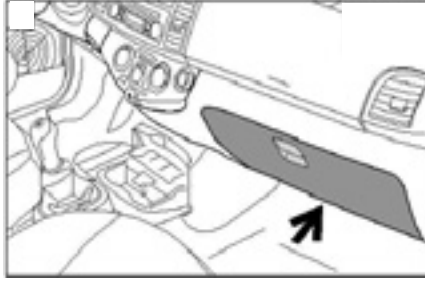
<p>--- Sandero II ---</p>	<p>01/13 -></p>	<p>*</p>		<p>CK 22011 216 x 200 x 35</p>  <p><u>O/E numbers</u> Dacia 272773016R / 272778214R</p> <p><u>Cross References</u> Fram CF11706 Mann CU22011 Micronair MP428 Purflux AH405 Tecnocar E626 Fiaam PC8374</p>	<p>CK 22011-C 216 x 200 x 35</p>  <p><u>O/E numbers</u> Dacia 272770567R / 272779683R</p> <p><u>Cross References</u> Fram CFA11706 Mann CUK22011 Micronair Purflux AHC405 Tecnocar EC696 Fiaam PCK8374</p>
 <p>I Il filtro è posizionato nell'abitacolo sotto il vano portaoggetti</p> <p>GB The filter is located in the passenger compartment under the glove compartment</p> <p>F Le filtre est situé dans l'habitacle en dessous de la boîte à gants</p> <p>D Der filter befindet sich im Fahrgastraum unter dem Handshuhfach</p> <p>E El filtro se encuentra en el habitáculo, bajo la guanterain de pasajerruimte</p>					

--	--	--

--	--	--



--	--	--





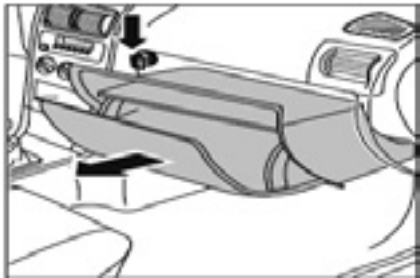

Anti-pollen

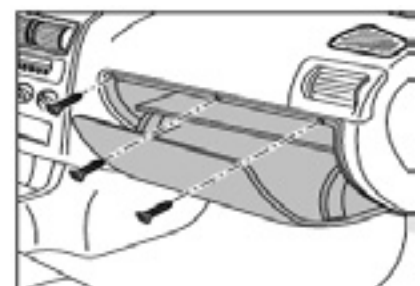

Activated carbon

DAIHATSU

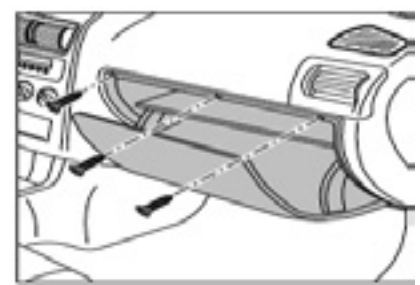
<p>--- Charade II ---</p>  <p> I Il filtro è posizionato nell'abitacolo dietro il vano portaoggetti GB The filter is located in the passenger compartment behind the glove compartment F Le filtre est situé dans l'habitacle derrière la boîte à gants D Der filter befindet sich im Fahrgastraum hinter dem Handsuhfach E El filtro se encuentra en el habitáculo detrás de la guantera </p>	<p>05/11 -></p>	<p>CK 1919 215 x 193 x 29</p>  <p><u>Q/E numbers</u> Daihatsu 871390D010</p> <p><u>Cross References</u> Fram CF10285/CF10322 Mann CU1919 Micronair MP273 Purflux AH256 Tecocar E467 Fiaam PC8186</p>	<p>CK 1919-C 215 x 193 x 29</p>  <p><u>Q/E numbers</u> Daihatsu 1780087820000</p> <p><u>Cross References</u> Fram CFA10322 Mann CUK1919 Micronair MC773 Purflux Tecocar EC467 Fiaam</p>
---	--------------------	---	---

<p>--- Cuore VII ---</p>  <p> I Il filtro è posizionato nell'abitacolo dietro il vano portaoggetti GB The filter is located in the passenger compartment behind the glove compartment F Le filtre est situé dans l'habitacle derrière la boîte à gants D Der filter befindet sich im Fahrgastraum hinter dem Handsuhfach E El filtro se encuentra en el habitáculo detrás de la guantera </p>	<p>09/07 -></p>	<p>CK 1827 185 x 180 x 30</p>  <p><u>Q/E numbers</u> Daihatsu 08975B4000100</p> <p><u>Cross References</u> Fram CF10202 Mann CU1827 Micronair MP198 Purflux AH249 Tecocar E457 Fiaam PC8176</p>	<p>---</p>
--	--------------------	--	------------

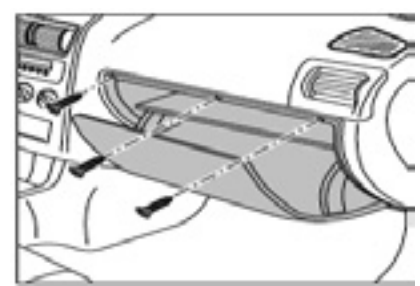
<p>--- Sirion II ---</p>  <p> I Il filtro è posizionato nell'abitacolo dietro il vano portaoggetti GB The filter is located in the passenger compartment behind the glove compartment F Le filtre est situé dans l'habitacle derrière la boîte à gants D Der filter befindet sich im Fahrgastraum hinter dem Handsuhfach E El filtro se encuentra en el habitáculo detrás de la guantera </p>	<p>01/05 -> * *</p>	<p>---</p>	<p>CK 1611-C 152 x 158 x 19</p>  <p><u>Q/E numbers</u> Daihatsu 9906-6850M2-038</p> <p><u>Cross References</u> Fram..... Mann CUK1611 Micronair MC699 Purflux..... Tecocar..... Fiaam.....</p>
--	------------------------	------------	--

<p>--- Terios ---</p>  <p> I Il filtro è posizionato nell'abitacolo dietro il vano portaoggetti GB The filter is located in the passenger compartment behind the glove compartment F Le filtre est situé dans l'habitacle derrière la boîte à gants D Der filter befindet sich im Fahrgastraum hinter dem Handsuhfach E El filtro se encuentra en el habitáculo detrás de la guantera </p>	<p>05/06 -> * *</p>	<p>CK 1827 185 x 180 x 30</p>  <p><u>Q/E numbers</u> Daihatsu 08975B4000100</p> <p><u>Cross References</u> Fram CF10202 Mann CU1827 Micronair MP198/MP252 Purflux AH249 Tecocar E457 Fiaam PC8176</p>	<p>---</p>
---	------------------------	--	------------

<p> </p>	<p> </p>	<p> </p>
----------	----------	----------



Anti-pollen

Activated carbon

DODGE

--- Avenger ---

08/07 ->

*

*

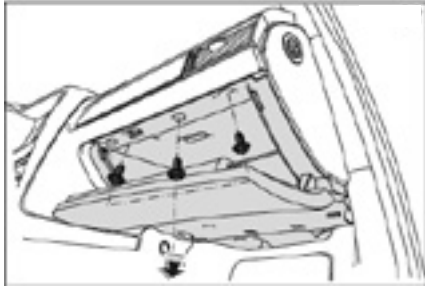

- I** Il filtro è posizionato nell'abitacolo sotto il vano portaoggetti
- GB** The filter is located in the passenger compartment under the glove compartment
- F** Le filtre est situé dans l'habitacle en dessous de la boîte à gants
- D** Der filter befindet sich im Fahrgastraum unter dem Handschuhfach
- E** El filtro se encuentra en el habitáculo, bajo la guantera de pasajerruimte

CK 2227

216 x 194 x 25



O/E numbers

Chrysler 05058693AA

Cross References

Fram CF11444 Mann CU2227
 Micronair MP325 Purflux AH365
 Tecocar E659 Fiaam PC8335

CK 2227-C

216 x 194 x 25

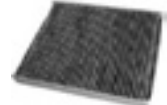

O/E numbers

Chrysler 05058381AA

Cross References

Fram Mann CUK2227
 Micronair MC825 Purflux
 Tecocar Fiaam

--- Caliber ---

07/06 ->

*

*

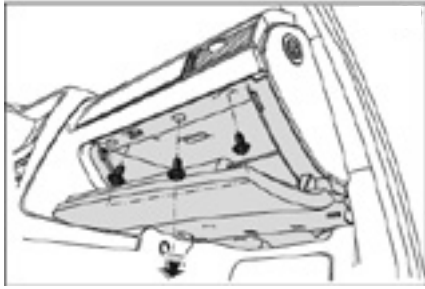

- I** Il filtro è posizionato nell'abitacolo sotto il vano portaoggetti
- GB** The filter is located in the passenger compartment under the glove compartment
- F** Le filtre est situé dans l'habitacle en dessous de la boîte à gants
- D** Der filter befindet sich im Fahrgastraum unter dem Handschuhfach
- E** El filtro se encuentra en el habitáculo, bajo la guantera de pasajerruimte

CK 2227

216 x 194 x 25



O/E numbers

Chrysler 05058693AA

Cross References

Fram CF11444 Mann CU2227
 Micronair MP325 Purflux AH365
 Tecocar E659 Fiaam PC8335

CK 2227-C

216 x 194 x 25

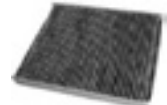

O/E numbers

Chrysler 05058381AA

Cross References

Fram Mann CUK2227
 Micronair MC825 Purflux
 Tecocar Fiaam

--- Nitro ---

05/07 ->

*

*

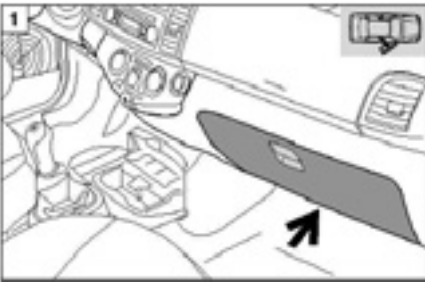

- I** Il filtro è posizionato nell'abitacolo sotto il vano portaoggetti
- GB** The filter is located in the passenger compartment under the glove compartment
- F** Le filtre est situé dans l'habitacle en dessous de la boîte à gants
- D** Der filter befindet sich im Fahrgastraum unter dem Handschuhfach
- E** El filtro se encuentra en el habitáculo, bajo la guantera de pasajerruimte

CK 1811-2

180 x 90 x 20

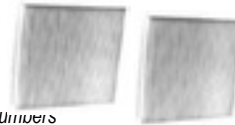

O/E numbers

Chrysler 68033193AA

Cross References

Fram Mann CU1811-2
 Micronair MP402-2 Purflux
 Tecocar Fiaam

CK 1811-C-2

180 x 90 x 20

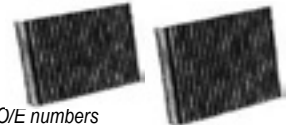

O/E numbers

Chrysler

Cross References

Fram Mann
 Micronair Purflux
 Tecocar Fiaam

--- Journey ---

06/08 ->

*

*

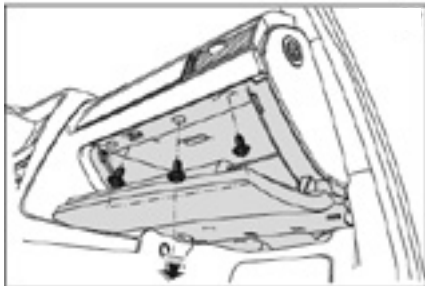

- I** Il filtro è posizionato nell'abitacolo sotto il vano portaoggetti
- GB** The filter is located in the passenger compartment under the glove compartment
- F** Le filtre est situé dans l'habitacle en dessous de la boîte à gants
- D** Der filter befindet sich im Fahrgastraum unter dem Handschuhfach
- E** El filtro se encuentra en el habitáculo, bajo la guantera de pasajerruimte

CK 2227

216 x 194 x 25



O/E numbers

Chrysler 05058693AA

Cross References

Fram CF11444 Mann CU2227
 Micronair MP325 Purflux AH365
 Tecocar E659 Fiaam PC8335

CK 2227-C

216 x 194 x 25

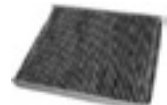

O/E numbers

Chrysler 05058381AA

Cross References

Fram Mann CUK2227
 Micronair MC825 Purflux
 Tecocar Fiaam









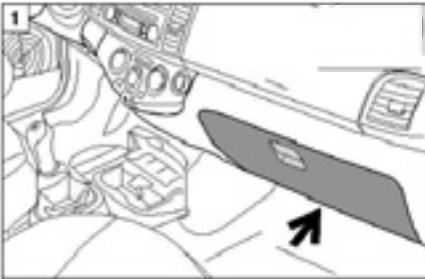

Anti-pollen

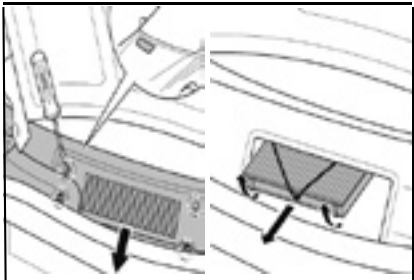

Activated carbon

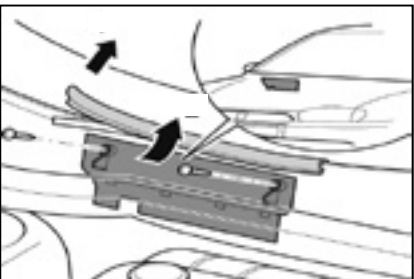

FIAT

<p>--- Albea ---</p> 	03/02 ->	*		<p>CK 321 257 x 164 x 21</p>  <p><u>O/E numbers</u> Fiat 7082301</p> <p><u>Cross References</u> Fram CF10893 Mann CU2629 Micronair MP321 Purflux AH381 Tecocar E673 Fiaam PC8350</p>	
	<p>I Il filtro è posizionato nell'abitacolo dietro il vano portaoggetti</p> <p>GB The filter is located in the passenger compartment behind the glove compartment</p> <p>F Le filtre est situé dans l'habitacle derrière la boîte à gants</p> <p>D Der filter befindet sich im Fahrgastraum hinter dem Handshuhfach</p> <p>E El filtro se encuentra en el habitáculo detrás de la guantera</p>				

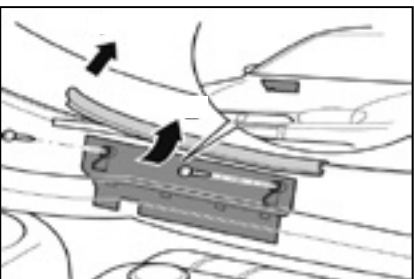
<p>--- Barchetta ---</p> 	01/95 ->	*		<p>CK 5818 309 x 140 x 17,5</p>  <p><u>O/E numbers</u> Fiat 46721374</p> <p><u>Cross References</u> Fram CF5818 Mann CU3138 Micronair MP021 Purflux AH108 Tecocar E302 Fiaam PC8014</p>	<p>CK 5818-C 309 x 140 x 17,5</p>  <p><u>O/E numbers</u> Fiat 46721371</p> <p><u>Cross References</u> Fram Mann Micronair MC521 Purflux Tecocar Fiaam</p>
	<p>I Il filtro è posizionato nel vano motore dietro la presa d'aria</p> <p>GB The filter is located in the engine compartment behind the ventilation grilles</p> <p>F Le filtre est situé dans le compartiment moteur derrière les grilles d'aération</p> <p>D Der filter befindet sich im Motorraum hinter den Lüftungsgittern</p> <p>E El filtro se encuentra en el compartimiento del motor, detrás de la rejilla de ventilación</p>				

<p>--- Brava ---</p> 	09/95 ->	*		<p>CK 5819 290 x 160 x 29</p>  <p><u>O/E numbers</u> Fiat 46442422 / 46768502</p> <p><u>Cross References</u> Fram CF5819 Mann CU2951/CU2956 Micronair MP039 Purflux AH107 Tecocar E305 Fiaam PC8011</p>	<p>CK 5819-C 290 x 160 x 29</p>  <p><u>O/E numbers</u> Fiat 60815647</p> <p><u>Cross References</u> Fram CFA8894 Mann CUK2951/CUK2956 Micronair MC539 Purflux AHC107 Tecocar EC305 Fiaam PCK8068</p>
	<p>I Il filtro è posizionato nel vano motore dietro la presa d'aria</p> <p>GB The filter is located in the engine compartment behind the ventilation grilles</p> <p>F Le filtre est situé dans le compartiment moteur derrière les grilles d'aération</p> <p>D Der filter befindet sich im motorraum hinter den Lüftungsgittern</p> <p>E El filtro se encuentra en el compartimiento del motor, detrás de la rejilla de ventilación</p>				

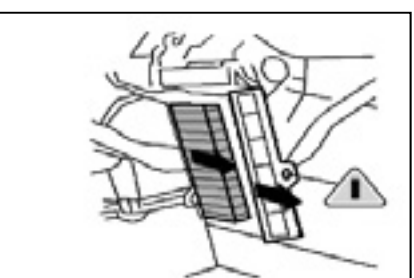
<p>--- Bravo ---</p> 	09/95 -> 12/01	*		<p>CK 5819 290 x 160 x 29</p>  <p><u>O/E numbers</u> Fiat 46442422 / 46768502</p> <p><u>Cross References</u> Fram CF5819 Mann CU2951/CU2956 Micronair MP039 Purflux AH107 Tecocar E305 Fiaam PC8011</p>	<p>CK 5819-C 290 x 160 x 29</p>  <p><u>O/E numbers</u> Fiat 60815647</p> <p><u>Cross References</u> Fram CFA8894 Mann CUK2951/CUK2956 Micronair MC539 Purflux AHC107 Tecocar EC305 Fiaam PCK8068</p>
	<p>I Il filtro è posizionato nel vano motore dietro la presa d'aria</p> <p>GB The filter is located in the engine compartment behind the ventilation grilles</p> <p>F Le filtre est situé dans le compartiment moteur derrière les grilles d'aération</p> <p>D Der filter befindet sich im motorraum hinter den Lüftungsgittern</p> <p>E El filtro se encuentra en el compartimiento del motor, detrás de la rejilla de ventilación</p>				

<p>--- Bravo II ---</p> 	03/07 ->	*		<p>CK 9533 232 x 177,5 x 20</p>  <p><u>O/E numbers</u> Fiat 46723435</p> <p><u>Cross References</u> Fram CF9533 Mann CU2422 Micronair MP096 Purflux AH190 Tecocar E393 Fiaam PC8100</p>	<p>CK 9533-C 232 x 177,5 x 20</p>  <p><u>O/E numbers</u> Fiat 46723435</p> <p><u>Cross References</u> Fram CFA9533 Mann CUK2422 Micronair MC596 Purflux AHC190 Tecocar EC393 Fiaam PCK8100</p>
	<p>I Il filtro è posizionato nell'abitacolo sotto il vano portaoggetti</p> <p>GB The filter is located in the passenger compartment under the glove compartment</p> <p>F Le filtre est situé dans l'habitacle en dessous de la boîte à gants</p> <p>D Der filter befindet sich im Fahrgastraum unter dem Handshuhfach</p> <p>E El filtro se encuentra en el habitáculo, bajo la guantera en el compartimiento de pasajeros</p>				



Anti-pollen

Activated carbon

FIAT

<p>--- Coupé ---</p>	03/94 ->	*		<p>CK 5823 385 x 173 x 20</p> <p><u>O/E numbers</u> Fiat 406409630 / 60812197</p> <p><u>Cross References</u> Fram CF5823 Mann CU3942 Micronair MP050 Purflux AH110/AH121 Tecocar E314 Fiaam PC8013</p>	<p>CK 5823-C 385 x 173 x 20</p> <p><u>O/E numbers</u> Fiat 46721923</p> <p><u>Cross References</u> Fram CFA8881 Mann..... Micronair MC550 Purflux..... Tecocar..... Fiaam PCK8070</p>
	<p>Il filtro è posizionato nel vano motore dietro la presa d'aria</p> <p>The filter is located in the engine compartment behind the ventilation grilles</p> <p>Le filtre est situé dans le compartiment moteur derrière les grilles d'aération</p> <p>Der filter befindet sich im Motorraum hinter den Lüftungsgittern</p> <p>El filtro se encuentra en el compartimiento del motor, detrás de la rejilla de ventilación</p>				

<p>--- Croma ---</p>	12/85 -> 12/96	*		<p>CK 5841 286 x 224 x 13</p> <p><u>O/E numbers</u> Fiat 60811242 / 82398550</p> <p><u>Cross References</u> Fram CF5841 Mann CU3136 Micronair MP027 Purflux AH109 Tecocar E304 Fiaam PC8008</p>	
	<p>Il filtro è posizionato nel vano motore</p> <p>The filter is located in the engine compartment</p> <p>Le filtre est situé dans le compartiment moteur</p> <p>Der filter befindet sich im Motorraum</p> <p>El filtro se encuentra en el compartimiento del motor</p>				

<p>--- Croma II ---</p>	06/05 ->	*		<p>CK 9495 332 x 164 x 30</p> <p><u>O/E numbers</u> Fiat.....</p> <p><u>Cross References</u> Fram CF9495/CF9531 Mann CU3337 Micronair MP107 Purflux AH198 Tecocar E400 Fiaam PC8097</p>	<p>CK 9495-C 332 x 164 x 30</p> <p><u>O/E numbers</u> Fiat 46844822</p> <p><u>Cross References</u> Fram CFA9495 Mann CUK3337 Micronair MC607/MC694 Purflux AHC198 Tecocar EC400 Fiaam PCK8097</p>
	<p>Il filtro è posizionato nel vano motore al centro</p> <p>The filter is located in the engine compartment centrally</p> <p>Le filtre est situé dans le compartiment moteur au centre</p> <p>Der Filter befindet sich im Motorraum mitting</p> <p>El filtro se encuentra en el compartimiento del motor, en el centro</p>				

<p>--- Doblò ---</p>	10/00 ->	*		<p>CK 9408 215 x 162,5 x 25</p> <p><u>O/E numbers</u> Fiat 46723331 / 77362394</p> <p><u>Cross References</u> Fram CF9408 Mann CU2335 Micronair MP078 Purflux AH201 Tecocar E403 Fiaam PC8093</p>	<p>CK 9408-C 231/220 x 215 x 30</p> <p><u>O/E numbers</u> Fiat 46722862 / 46722863 / 46770829</p> <p><u>Cross References</u> Fram CFA9408 Mann CUK2335 Micronair MC578 Purflux AHC154 Tecocar EC358 Fiaam PCK8093</p>
	<p>Il filtro è posizionato nell'abitacolo dietro il vano portaoggetti</p> <p>The filter is located in the passenger compartment behind the glove compartment</p> <p>Le filtre est situé dans l'habitacle derrière la boîte à gants</p> <p>Der filter befindet sich im Fahrgastraum hinter dem Handshuhfach</p> <p>El filtro se encuentra en el habitáculo detrás de la guantera</p>				



<p>--- Doblò ---</p>	02/01 ->	*		<p>CK 9408 215 x 162,5 x 25</p> <p><u>O/E numbers</u> Fiat 46723331 / 77362394</p> <p><u>Cross References</u> Fram CF9408 Mann CU2335 Micronair MP078 Purflux AH201 Tecocar E403 Fiaam PC8093</p>	<p>CK 9408/1-C 215 x 162,5 x 25</p> <p><u>O/E numbers</u> Fiat 46723331</p> <p><u>Cross References</u> Fram Mann Micronair Purflux Tecocar Fiaam</p>
	<p>Il filtro è posizionato nell'abitacolo dietro il vano portaoggetti</p> <p>The filter is located in the passenger compartment behind the glove compartment</p> <p>Le filtre est situé dans l'habitacle derrière la boîte à gants</p> <p>Der filter befindet sich im Fahrgastraum hinter dem Handshuhfach</p> <p>El filtro se encuentra en el habitáculo detrás de la guantera</p>				





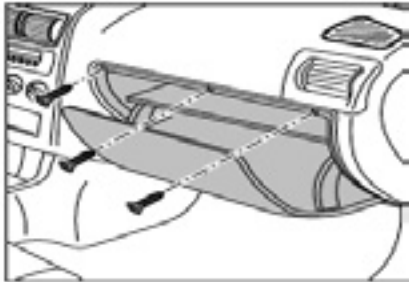

Anti-pollen

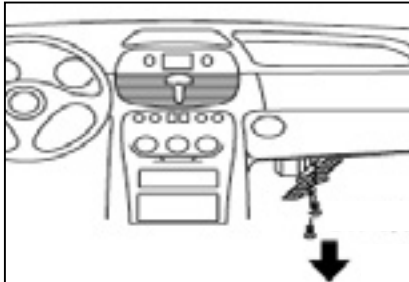

Activated carbon

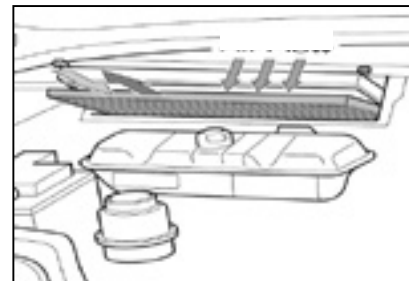

FIAT

<p>--- Doblò II --- Left-hand drive</p> 	<p>01/10 -> * <input type="checkbox"/></p> <p>I Il filtro è posizionato nell'abitacolo dietro il vano portaoggetti GB The filter is located in the passenger compartment behind the glove compartment F Le filtre est situé dans l'habitacle derrière la boîte à gants D Der filter befindet sich im Fahrgastraum hinter dem Handshuhfach E El filtro se encuentra en el habitáculo detrás de la guantera</p>	<p>CK 10413-10 199 x 177,5 x 30</p>  <p><u>O/E numbers</u> Fiat 77364561</p> <p><u>Cross References</u> Fram CF10413 Mann CU2040 Micronair MP283 Purflux AH265 Tecnocar Fiaam PC8200</p>	<p>---</p>
--	---	---	------------

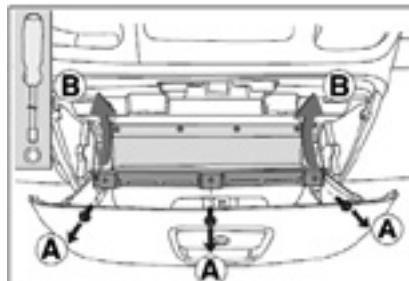
<p>--- Doblò II --- Right-hand drive</p> 	<p>01/10 -> * <input type="checkbox"/></p> <p>I Il filtro è posizionato nell'abitacolo dietro il vano portaoggetti GB The filter is located in the passenger compartment behind the glove compartment F Le filtre est situé dans l'habitacle derrière la boîte à gants D Der filter befindet sich im Fahrgastraum hinter dem Handshuhfach E El filtro se encuentra en el habitáculo detrás de la guantera</p>	<p>CK 2243 265 x 217 x 20,5</p>  <p><u>O/E numbers</u> Fiat 55702456</p> <p><u>Cross References</u> Fram CF10282 Mann CU2243 Micronair MP193 Purflux AH244 Tecnocar E465 Fiaam PC8170</p>	<p>CK 2243-C 265 x 217 x 20,5</p>  <p><u>O/E numbers</u> Fiat 55702468</p> <p><u>Cross References</u> Fram CFA10365 Mann CUK2243 Micronair MC693 Purflux AHC244 Tecnocar EC465 Fiaam PCK8194</p>
---	---	--	--

<p>--- Ducato ---</p> 	<p>01/94 -> 03/02 * <input type="checkbox"/></p> <p>I Il filtro è posizionato nel vano motore sul lato passeggero GB The filter is located in the engine compartment on the passenger's side F Le filtre est situé dans le compartiment moteur du côté passager D Der filter befindet sich Motorraum auf der Beifahrerseite E El filtro se encuentra en el compartimiento del motor, del lado del acompañante</p>	<p>CK 8890 435 x 144,5 x 17</p>  <p><u>O/E numbers</u> Fiat 1312764080 / 1312766080</p> <p><u>Cross References</u> Fram CF8890 Mann CU4442 Micronair MP013 Purflux AH231 Tecnocar E430 Fiaam PC8051</p>	<p>---</p>
--	---	--	------------

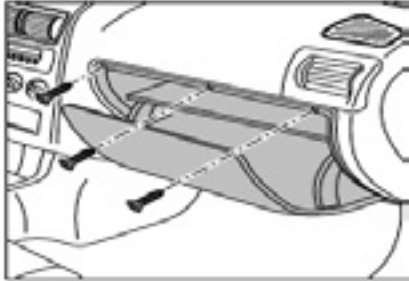
<p>--- Ducato 2007 ---</p> 	<p>07/06 -> * <input type="checkbox"/></p> <p>I Il filtro è posizionato nell'abitacolo dietro il vano portaoggetti GB The filter is located in the passenger compartment behind the glove compartment F Le filtre est situé dans l'habitacle derrière la boîte à gants D Der filter befindet sich im Fahrgastraum hinter dem Handshuhfach E El filtro se encuentra en el habitáculo detrás de la guantera</p>	<p>CK 2544 250 x 234 x 25</p>  <p><u>O/E numbers</u> Fiat 77364063</p> <p><u>Cross References</u> Fram CF10420 Mann CU2544 Micronair MP262 Purflux AH263 Tecnocar E476 Fiaam PC8205</p>	<p>---</p>
---	---	--	------------



<p>--- Fiorino (225) --- Left-hand drive</p> 	<p>02/08 -> * <input type="checkbox"/></p> <p>I Il filtro è posizionato nell'abitacolo dietro il vano portaoggetti GB The filter is located in the passenger compartment behind the glove compartment F Le filtre est situé dans l'habitacle derrière la boîte à gants D Der filter befindet sich im Fahrgastraum hinter dem Handshuhfach E El filtro se encuentra en el habitáculo detrás de la guantera</p>	<p>CK 10413-10 199 x 177,5 x 30</p>  <p><u>O/E numbers</u> Fiat 77364561</p> <p><u>Cross References</u> Fram CF10413 Mann CU2040 Micronair MP283 Purflux AH265 Tecnocar Fiaam PC8200</p>	<p>---</p>
---	---	---	------------





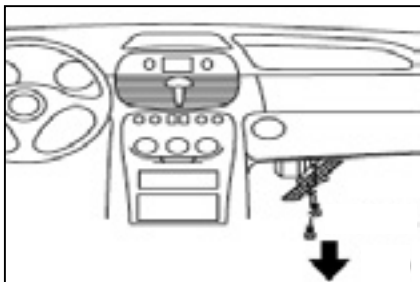

Anti-pollen

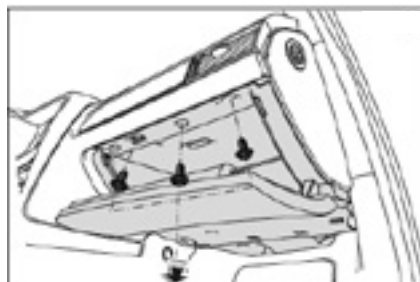

Activated carbon

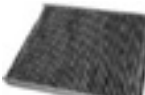

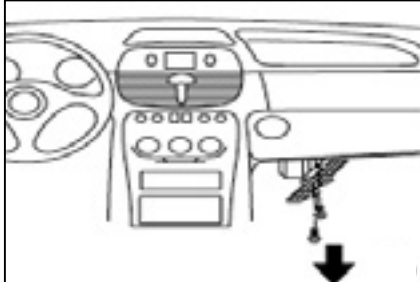
FIAT

<p>--- Fiorino (225) --- Right-hand drive</p>  <p> 02/08 -> * </p> <p> I Il filtro è posizionato nell'abitacolo dietro il vano portaoggetti GB The filter is located in the passenger compartment behind the glove compartment F Le filtre est situé dans l'habitacle derrière la boîte à gants D Der filter befindet sich im Fahrgastraum hinter dem Handshuhfach E El filtro se encuentra en el habitáculo detrás de la guantera </p>	<p>CK 2243 265 x 217 x 20,5</p>  <p><u>O/E numbers</u> Fiat 55702456</p> <p><u>Cross References</u> Fram CF10282 Mann CU2243 Micronair MP193 Purflux AH244 Tecnocar E465 Fiaam PC8170</p>	<p>CK 2243-C 265 x 217 x 20,5</p>  <p><u>O/E numbers</u> Fiat 55702468</p> <p><u>Cross References</u> Fram CFA10365 Mann CUK2243 Micronair MC693 Purflux AHC244 Tecnocar EC465 Fiaam PCK8194</p>
---	---	---

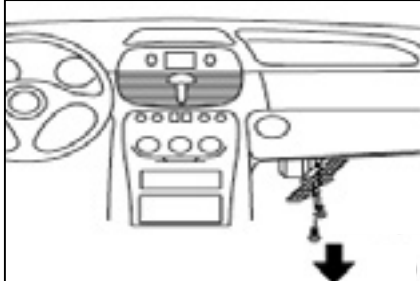
<p>--- Freemont ---</p>  <p> 08/11 -> * * </p> <p> I Il filtro è posizionato nell'abitacolo sotto il vano portaoggetti GB The filter is located in the passenger compartment under the glove compartment F Le filtre est situé dans l'habitacle en dessous de la boîte à gants D Der filter befindet sich im Fahrgastraum unter dem Handshuhfach E El filtro se encuentra en el habitáculo, bajo la guantera in de passagieruimte </p>	<p>CK 2227 216 x 194 x 25</p>  <p><u>O/E numbers</u> Chrysler 05058693AA</p> <p><u>Cross References</u> Fram CF11444 Mann CU2227 Micronair MP325 Purflux AH365 Tecnocar E659 Fiaam PC8335</p>	<p>CK 2227-C 216 x 194 x 25</p>  <p><u>O/E numbers</u> Chrysler 05058381AA</p> <p><u>Cross References</u> Fram Mann CUK2227 Micronair MC825 Purflux Tecnocar Fiaam</p>
---	---	---

<p>--- Idea ---</p>  <p> 10/04 -> * </p> <p> I Il filtro è posizionato nell'abitacolo dietro il vano portaoggetti GB The filter is located in the passenger compartment behind the glove compartment F Le filtre est situé dans l'habitacle derrière la boîte à gants D Der filter befindet sich im Fahrgastraum hinter dem Handshuhfach E El filtro se encuentra en el habitáculo detrás de la guantera </p>	<p>CK 9408 215 x 162,5 x 25</p>  <p><u>O/E numbers</u> Fiat 46723331 / 77362394</p> <p><u>Cross References</u> Fram CF9408 Mann CU2335 Micronair MP078 Purflux AH201 Tecnocar E403 Fiaam PC8093</p>	<p>CK 9408-C 231/220 x 215 x 30</p>  <p><u>O/E numbers</u> Fiat 46722862 / 46722863 / 46770829</p> <p><u>Cross References</u> Fram CFA9408 Mann CUK2335 Micronair MC578 Purflux AHC154 Tecnocar EC358 Fiaam PCK8093</p>
---	---	--

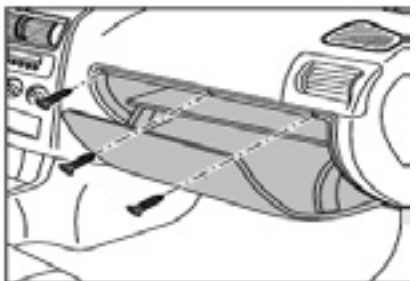
<p>--- Idea ---</p>  <p> 01/04 -> * </p> <p> I Il filtro è posizionato nell'abitacolo dietro il vano portaoggetti GB The filter is located in the passenger compartment behind the glove compartment F Le filtre est situé dans l'habitacle derrière la boîte à gants D Der filter befindet sich im Fahrgastraum hinter dem Handshuhfach E El filtro se encuentra en el habitáculo detrás de la guantera </p>	<p>CK 9408 215 x 162,5 x 25</p>  <p><u>O/E numbers</u> Fiat 46723331 / 77362394</p> <p><u>Cross References</u> Fram CF9408 Mann CU2335 Micronair MP078 Purflux AH201 Tecnocar E403 Fiaam PC8093</p>	<p>CK 9408/1-C 215 x 162,5 x 25</p>  <p><u>O/E numbers</u> Fiat 46723331</p> <p><u>Cross References</u> Fram Mann Micronair Purflux Tecnocar Fiaam</p>
---	---	---



<p>--- Linea ---</p>  <p> 06/07 -> * </p> <p> I Il filtro è posizionato nell'abitacolo dietro il vano portaoggetti GB The filter is located in the passenger compartment behind the glove compartment F Le filtre est situé dans l'habitacle derrière la boîte à gants D Der filter befindet sich im Fahrgastraum hinter dem Handshuhfach E El filtro se encuentra en el habitáculo detrás de la guantera </p>	<p>CK 10413-10 199 x 177,5 x 30</p>  <p><u>O/E numbers</u> Fiat 77364561</p> <p><u>Cross References</u> Fram CF10413 Mann CU2040 Micronair MP283 Purflux AH265 Tecnocar Fiaam PC8200</p>	
--	--	--





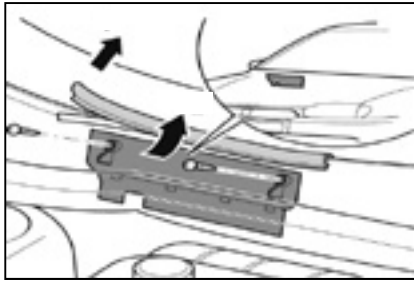

Anti-pollen

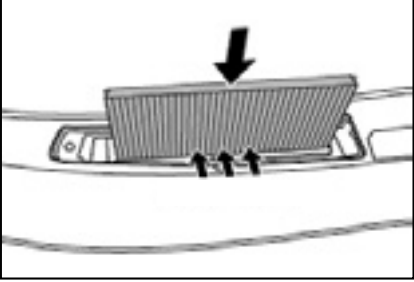

Activated carbon

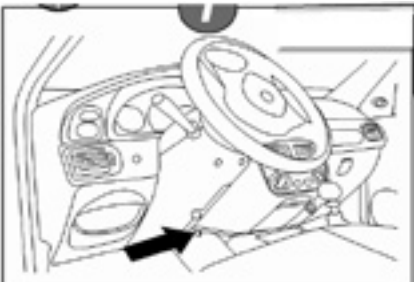

FIAT

<p>--- Marea ---</p> 	09/96 ->	*		<p>CK 5819 290 x 160 x 29</p>  <p><u>O/E numbers</u> Fiat 46442422 / 46768502</p> <p><u>Cross References</u> Fram CF5819 Mann CU2951/CU2956 Micronair MP039 Purflux AH107 Tecnocar E305 Fiaam PC8011</p>	<p>CK 5819-C 290 x 160 x 29</p>  <p><u>O/E numbers</u> Fiat 60815647</p> <p><u>Cross References</u> Fram CFA8894 Mann CUK2951/CUK2956 Micronair MC539 Purflux AHC107 Tecnocar EC305 Fiaam PCK8068</p>
	<p>I Il filtro è posizionato nel vano motore dietro la presa d'aria</p> <p>GB The filter is located in the engine compartment behind the ventilation grille</p> <p>F Le filtre est situé dans le compartiment moteur derrière les grilles d'aération</p> <p>D Der filter befindet sich im motorraum hinter den Lüftungsgittern</p> <p>E El filtro se encuentra en el compartimiento del motor, detrás de la rejilla de ventilación</p>				

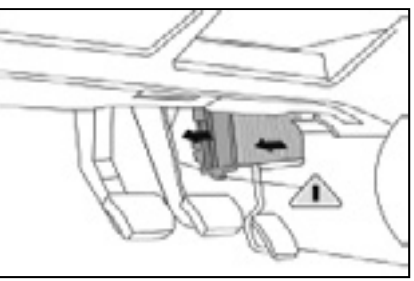
<p>--- Multipla ---</p> 	04/99 ->	*		<p>CK 9077 273 x 160 x 35</p>  <p><u>O/E numbers</u> Fiat 46794399</p> <p><u>Cross References</u> Fram CF9077 Mann CU3020 Micronair MP081 Purflux..... Tecnocar..... Fiaam PC8044</p>	<p>CK 9077-C 273 x 160 x 35</p>  <p><u>O/E numbers</u> Fiat 46513960</p> <p><u>Cross References</u> Fram CFA9077 Mann CUK3020 Micronair MC581 Purflux AHC153 Tecnocar EC357 Fiaam PCK8044</p>
	<p>I Il filtro è posizionato nell'abitacolo sul lato conducente</p> <p>GB The filter is located in the passenger compartment on the driver's side</p> <p>F Le filtre est situé dans l'habitacle du côté conducteur</p> <p>D Der Filter befindet sich im Fahrgastraum auf der Fahrerseite</p> <p>E El Filtro se encuentra en el habitáculo, del lado del conductor</p>				

<p>--- Palio I ---</p> 	04/96 -> 06/98			<p>CK 8989 230 x 213 x 12</p>  <p><u>O/E numbers</u> Fiat 7078711</p> <p><u>Cross References</u> Fram CF8989 Mann CU2344 Micronair MP191 Purflux AH174 Tecnocar E371 Fiaam PC8148</p>	
	<p>I Il filtro è posizionato nell'abitacolo sul lato conducente</p> <p>GB The filter is located in the passenger compartment on the driver's side</p> <p>F Le filtre est situé dans l'habitacle du côté conducteur</p> <p>D Der Filter befindet sich im Fahrgastraum auf der Fahrerseite</p> <p>E El Filtro se encuentra en el habitáculo, del lado del conductor</p>				

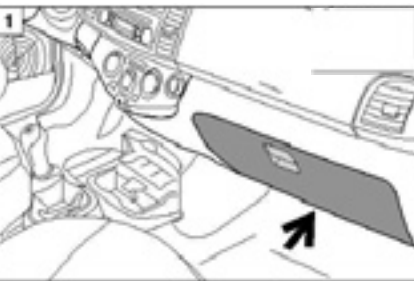
<p>--- Palio II ---</p> 	08/98 -> 08/99	*		<p>CK 2504 236/230 x 169,5 x 3,5</p>  <p><u>O/E numbers</u> Fiat 7079682</p> <p><u>Cross References</u> Fram..... Mann CU2504 Micronair MP192 Purflux..... Tecnocar..... Fiaam.....</p>	
	<p>I Il filtro è posizionato nell'abitacolo sul lato conducente</p> <p>GB The filter is located in the passenger compartment on the driver's side</p> <p>F Le filtre est situé dans l'habitacle du côté conducteur</p> <p>D Der Filter befindet sich im Fahrgastraum auf der Fahrerseite</p> <p>E El Filtro se encuentra en el habitáculo, del lado del conductor</p>				

<p>--- Palio III ---</p> 	06/99 ->	*		<p>CK 321 257 x 164 x 21</p>  <p><u>O/E numbers</u> Fiat 7082301</p> <p><u>Cross References</u> Fram CF10893 Mann CU2629 Micronair MP321 Purflux AH381 Tecnocar E673 Fiaam PC8350</p>	
	<p>I Il filtro è posizionato nell'abitacolo dietro il vano portaoggetti</p> <p>GB The filter is located in the passenger compartment behind the glove compartment</p> <p>F Le filtre est situé dans l'habitacle derrière la boîte à gants</p> <p>D Der filter befindet sich im Fahrgastraum hinter dem Handshuhfach</p> <p>E El filtro se encuentra en el habitáculo detrás de la guantera</p>				



Anti-pollen

Activated carbon

FIAT

--- Panda II ---

09/03 ->

*

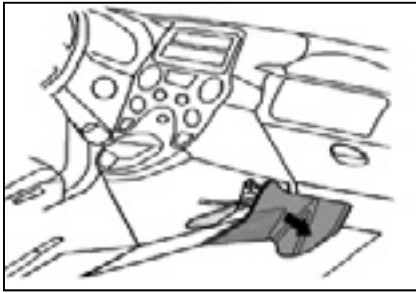

- I** Il filtro è posizionato nell'abitacolo sotto il vano portaoggetti
- GB** The filter is located in the passenger compartment under the glove compartment
- F** Le filtre est situé dans l'habitacle en dessous de la boîte à gants
- D** Der filter befindet sich im Fahrgastraum unter dem Handshuhfach
- E** El filtro se encuentra en el habitáculo, bajo la guanterain de passajeriuinte

CK 10025

202 x 176 x 18



O/E numbers

Fiat 46723321

Cross References

Fram CF10025 Mann CU2026
 Micronair MP163 Purflux AH233
 Tecnocar E432 Fiaam PC8159

CK 10025-C

202 x 176 x 18



O/E numbers

Fiat 77365763

Cross References

Fram Mann CUK2026
 Micronair MC663 Purflux
 Tecnocar Fiaam

--- Panda III ---

01/12 ->

*

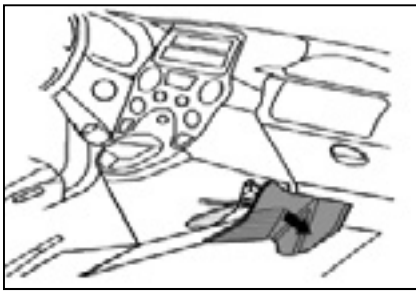

- I** Il filtro è posizionato nell'abitacolo sotto il vano portaoggetti
- GB** The filter is located in the passenger compartment under the glove compartment
- F** Le filtre est situé dans l'habitacle en dessous de la boîte à gants
- D** Der filter befindet sich im Fahrgastraum unter dem Handshuhfach
- E** El filtro se encuentra en el habitáculo, bajo la guanterain de passajeriuinte

CK 20006

194 x 188 x 30



O/E numbers

Fiat 51854923

Cross References

Fram CF11470 Mann CU20006
 Micronair MP412 Purflux AH371
 Tecnocar E665 Fiaam PC8340

CK 20006-C

194 x 188 x 30



O/E numbers

Fiat 71775823

Cross References

Fram Mann CUK20006
 Micronair Purflux
 Tecnocar Fiaam

--- Punto I ---

09/93 -> 09/99

*

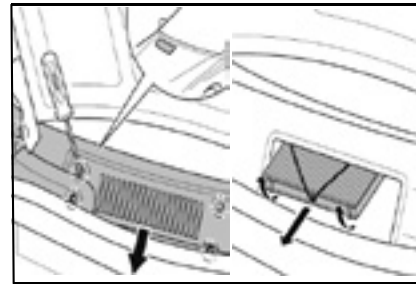

- I** Il filtro è posizionato nel vano motore dietro la presa d'aria
- GB** The filter is located in the engine compartment behind the ventilation grilles
- F** Le filtre est situé dans le compartiment moteur derrière les grilles d'aération
- D** Der filter befindet sich im Motorraum hinter den Lüftungsgittern
- E** El filtro se encuentra en el compartimiento del motor, detrás de la rejilla de ventilación

CK 5818

309 x 140 x 17,5



O/E numbers

Fiat 46721374

Cross References

Fram CF5818 Mann CU3138
 Micronair MP021 Purflux AH108
 Tecnocar E302 Fiaam PC8014

CK 5818-C

309 x 140 x 17,5



O/E numbers

Fiat 46721371

Cross References

Fram Mann
 Micronair MC521 Purflux
 Tecnocar Fiaam

--- Punto II ---

01/01 ->

*

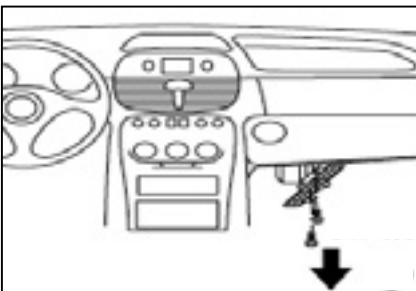

- I** Il filtro è posizionato nell'abitacolo dietro il vano portaoggetti
- GB** The filter is located in the passenger compartment behind the glove compartment
- F** Le filtre est situé dans l'habitacle derrière la boîte à gants
- D** Der filter befindet sich im Fahrgastraum hinter dem Handshuhfach
- E** El filtro se encuentra en el habitáculo detrás de la guantera

CK 9408

215 x 162,5 x 25



O/E numbers

Fiat 46723331 / 77362394

Cross References

Fram CF9408 Mann CU2335
 Micronair MP078 Purflux AH201
 Tecnocar E403 Fiaam PC8093

CK 9408/1-C

215 x 162,5 x 25



O/E numbers

Fiat 46723331

Cross References

Fram Mann
 Micronair Purflux
 Tecnocar Fiaam

--- Punto II ---

07/03 ->

*

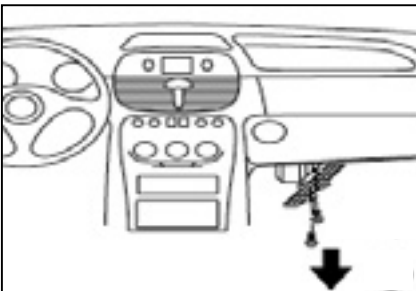

- I** Il filtro è posizionato nell'abitacolo dietro il vano portaoggetti
- GB** The filter is located in the passenger compartment behind the glove compartment
- F** Le filtre est situé dans l'habitacle derrière la boîte à gants
- D** Der filter befindet sich im Fahrgastraum hinter dem Handshuhfach
- E** El filtro se encuentra en el habitáculo detrás de la guantera

CK 9408

215 x 162,5 x 25



O/E numbers

Fiat 46723331 / 77362394

Cross References

Fram CF9408 Mann CU2335
 Micronair MP078 Purflux AH201
 Tecnocar E403 Fiaam PC8093

CK 9408-C

231/220 x 215 x 30



O/E numbers

Fiat 46722862 / 46722863 / 46770829

Cross References

Fram CFA9408 Mann CUK2335
 Micronair MC578 Purflux AHC154
 Tecnocar EC358 Fiaam PCK8093



Anno di fabbricazione / Year of construction
 Anné de fabrication / Baujahr / Año de fabricación



Con climatizzatore / With air-conditioning / Avec climatisation
 Mit Klimaanlage / Con instalación de aire acondicionado





Senza climatizzatore / Without air-conditioning / Sans climatisation
 Ohne Klimaanlage / Sin instalación de aire acondicionado





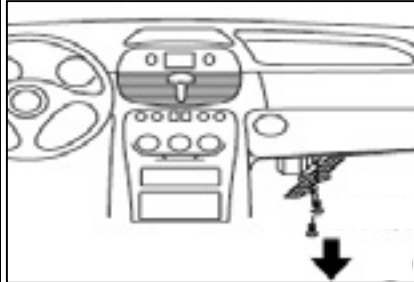

Anti-pollen

Activated carbon

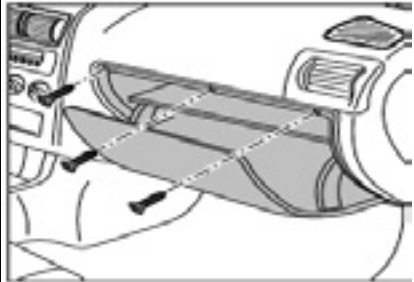

FIAT

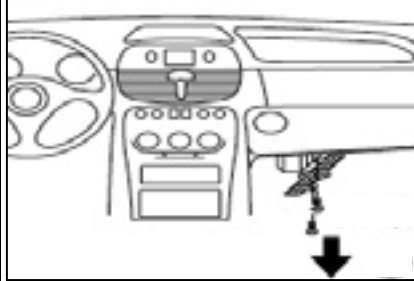
<p>--- Punto III / Grande Punto / Evo ---</p>  <p> I Il filtro è posizionato nell'abitacolo dietro il vano portaoggetti GB The filter is located in the passenger compartment behind the glove compartment F Le filtre est situé dans l'habitacle derrière la boîte à gants D Der filter befindet sich im Fahrgastraum hinter dem Handshuhfach E El filtro se encuentra en el habitáculo detrás de la guantera </p>	<p>07/08 -> * <input type="checkbox"/></p>	<p>CK 2243 265 x 217 x 20,5</p>  <p><u>O/E numbers</u> Fiat 55702456 <u>Cross References</u> Fram CF10282 Mann CU2243 Micronair MP193 Purflux AH244 Tecnocar E465 Fiaam PC8170</p>	<p>CK 2243-C 265 x 217 x 20,5</p>  <p><u>O/E numbers</u> Fiat 55702468 <u>Cross References</u> Fram CFA10365 Mann CUK2243 Micronair MC693 Purflux AHC244 Tecnocar EC465 Fiaam PCK8194</p>
--	---	---	---

<p>--- Qubo --- Left-hand drive</p>  <p> I Il filtro è posizionato nell'abitacolo dietro il vano portaoggetti GB The filter is located in the passenger compartment behind the glove compartment F Le filtre est situé dans l'habitacle derrière la boîte à gants D Der filter befindet sich im Fahrgastraum hinter dem Handshuhfach E El filtro se encuentra en el habitáculo detrás de la guantera </p>	<p>11/08 -> * <input type="checkbox"/></p>	<p>CK 10413-10 199 x 177,5 x 30</p>  <p><u>O/E numbers</u> Fiat 77364561 <u>Cross References</u> Fram CF10413 Mann CU2040 Micronair MP283 Purflux AH265 Tecnocar Fiaam PC8200</p>	<p>---</p>
--	---	--	------------

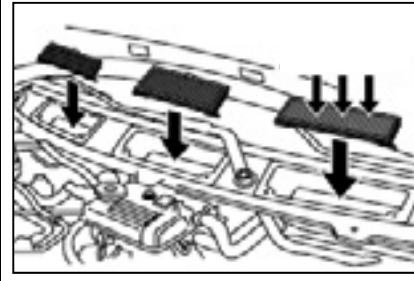
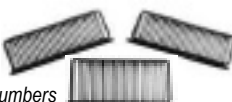
<p>--- Qubo --- Right-hand drive</p>  <p> I Il filtro è posizionato nell'abitacolo dietro il vano portaoggetti GB The filter is located in the passenger compartment behind the glove compartment F Le filtre est situé dans l'habitacle derrière la boîte à gants D Der filter befindet sich im Fahrgastraum hinter dem Handshuhfach E El filtro se encuentra en el habitáculo detrás de la guantera </p>	<p>11/08 -> * <input type="checkbox"/></p>	<p>CK 2243 265 x 217 x 20,5</p>  <p><u>O/E numbers</u> Fiat 55702456 <u>Cross References</u> Fram CF10282 Mann CU2243 Micronair MP193 Purflux AH244 Tecnocar E465 Fiaam PC8170</p>	<p>CK 2243-C 265 x 217 x 20,5</p>  <p><u>O/E numbers</u> Fiat 55702468 <u>Cross References</u> Fram CFA10365 Mann CUK2243 Micronair MC693 Purflux AHC244 Tecnocar EC465 Fiaam PCK8194</p>
---	---	---	---

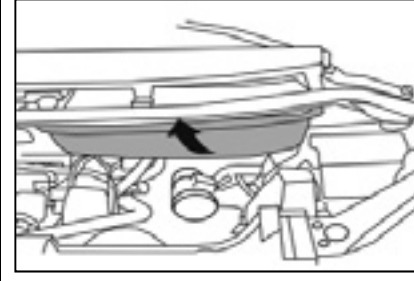
<p>--- Scudo I ---</p>  <p> I Il filtro è posizionato nel vano motore sul lato passeggero GB The filter is located in the engine compartment on the passenger's side F Le filtre est situé dans le compartiment moteur du côté passager D Der filter befindet sich Motorraum auf der Beifahrerseite E El filtro se encuentra en el compartimiento del motor, del lado del acompañante </p>	<p>02/96 -> 03/04 * <input type="checkbox"/></p>	<p>CK 8947-3 1) 194 x 94/86 x 33 2) 194 x 67/64 x 33</p>  <p><u>O/E numbers</u> Fiat 1475478080 / 1475479080 <u>Cross References</u> Fram CF8947/CF8948 Mann CU19000-3 Micronair MP087-3 Purflux AH112/AH113 Tecnocar E315/E316 Fiaam PC8055/PC8056</p>	<p>---</p>
---	---	--	------------

<p>--- Scudo I ---</p>  <p> I Il filtro è posizionato nel vano motore sul lato passeggero GB The filter is located in the engine compartment on the passenger's side F Le filtre est situé dans le compartiment moteur du côté passager D Der filter befindet sich Motorraum auf der Beifahrerseite E El filtro se encuentra en el compartimiento del motor, del lado del acompañante </p>	<p>03/04 -> 01/07 * <input type="checkbox"/></p>	<p>CK 9586 405 x 164 x 32</p>  <p><u>O/E numbers</u> Fiat 1484383080 <u>Cross References</u> Fram CF9586 Mann CU4179 Micronair MP116 Purflux AH205 Tecnocar E408 Fiaam PC8108</p>	<p>CK 9586-C 405 x 164 x 32</p>  <p><u>O/E numbers</u> Fiat 9655190480 <u>Cross References</u> Fram CFA10307 Mann CUK4179 Micronair MC616 Purflux AHC205 Tecnocar EC408 Fiaam PCK8190</p>
---	---	--	---



Anti-pollen

Activated carbon

FIAT

--- Scudo II ---

01/07 ->

*

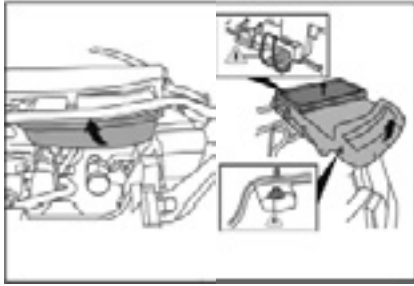

- Il filtro è posizionato nel vano motore
- The filter is located in the engine compartment
- Le filtre est situé dans le compartiment moteur
- Der Filter befindet sich im Motorraum
- El filtro se encuentra en el compartimiento del motor

CK 10366-10

375 x 175 x 48



O/E numbers

Fiat 1497497080

Cross References

Fram Mann CU3847
 Micronair MP300 Purflux
 Tecnicar Fiaam

CK 10366-10-C

375 x 175 x 48



O/E numbers

Fiat 1497498080

Cross References

Fram CFA10366 Mann CUK3847
 Micronair MC800 Purflux AHC258
 Tecnicar EC464 Fiaam PCK8193

--- Sedici ---

03/06 ->

*

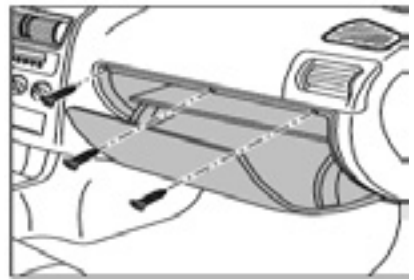

- Il filtro è posizionato nell'abitacolo dietro il vano portaoggetti
- The filter is located in the passenger compartment behind the glove compartment
- Le filtre est situé dans l'habitacle derrière la boîte à gants
- Der filter befindet sich im Fahrgastraum hinter dem Handshuhfach
- El filtro se encuentra en el habitáculo detrás de la guantera

CK 1827

185 x 180 x 30



O/E numbers

Fiat 71743821

Cross References

Fram CF10202 Mann CU1827
 Micronair MP252/MP198 Purflux AH249
 Tecnicar E457 Fiaam PC8176

--- Siena ---

04/96 -> 06/98

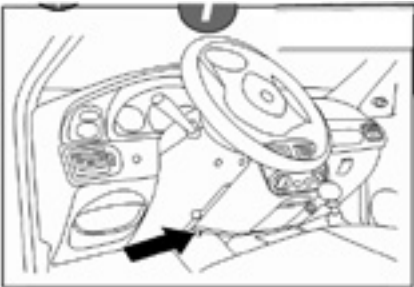

- Il filtro è posizionato nell'abitacolo sul lato conducente
- The filter is located in the passenger compartment on the driver's side
- Le filtre est situé dans l'habitacle du côté conducteur
- Der Filter befindet sich im Fahrgastraum auf der Fahrerseite
- El Filtro se encuentra en el habitáculo, del lado del conductor

CK 8989

230 x 213 x 12



O/E numbers

Fiat 7078711

Cross References

Fram CF8989 Mann CU2344
 Micronair MP191 Purflux AH174
 Tecnicar E371 Fiaam PC8148

--- Siena ---

08/98 ->

*

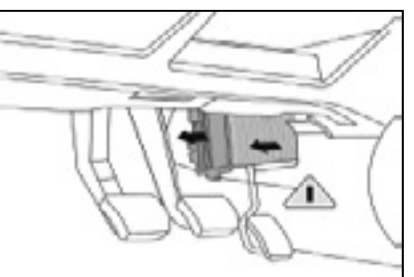

- Il filtro è posizionato nell'abitacolo sul lato conducente
- The filter is located in the passenger compartment on the driver's side
- Le filtre est situé dans l'habitacle du côté conducteur
- Der Filter befindet sich im Fahrgastraum auf der Fahrerseite
- El Filtro se encuentra en el habitáculo, del lado del conductor

CK 2504

236/230 x 169,5 x 3,5



O/E numbers

Fiat 7079682

Cross References

Fram..... Mann CU2504
 Micronair MP192 Purflux.....
 Tecnicar..... Fiaam.....

--- Stilo + Multiwagon ---

10/01 ->

*



- Il filtro è posizionato nell'abitacolo sotto il vano portaoggetti
- The filter is located in the passenger compartment under the glove compartment
- Le filtre est situé dans l'habitacle en dessous de la boîte à gants
- Der filter befindet sich im Fahrgastraum unter dem Handshuhfach
- El filtro se encuentra en el habitáculo, bajo la guantera/de pasajerruimte

CK 9533

232 x 177,5 x 20



O/E numbers

Fiat 46723435

Cross References

Fram CF9533 Mann CU2422
 Micronair MP096 Purflux AH190
 Tecnicar E393 Fiaam PC8100

CK 9533-C

232 x 177,5 x 20



O/E numbers

Fiat 46723435

Cross References

Fram CFA9533 Mann CUK2422
 Micronair MC596 Purflux AHC190
 Tecnicar EC393 Fiaam PCK8100



Anno di fabbricazione / Year of construction
 Anné de fabrication / Baujahr / Año de fabricación



Con climatizzatore / With air-conditioning / Avec climatisation
 Mit Klimaanlage / Con instalación de aire acondicionado





Senza climatizzatore / Without air-conditioning / Sans climatisation
 Ohne Klimaanlage / Sin instalación de aire acondicionado





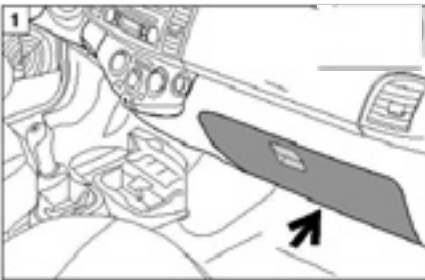

Anti-pollen

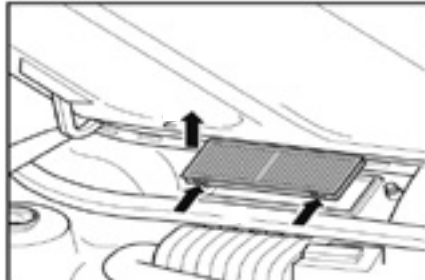

Activated carbon

FIAT

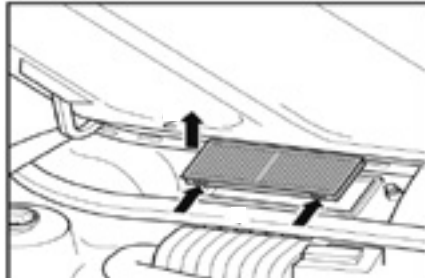
<p>--- Strada ---</p> 	<p>06/99 -> * <input type="checkbox"/></p>	<p>CK 321 257 x 164 x 21</p>  <p><u>O/E numbers</u> Fiat 7082301</p> <p><u>Cross References</u> Fram CF10893 Mann CU2629 Micronair MP321 Purflux AH381 Tecnocar E673 Fiaam PC8350</p>	<p>---</p>
--	---	--	------------

<p>--- Tempra ---</p> 	<p>03/90 -> 08/97 * <input type="checkbox"/></p>	<p>CK 5823 385 x 173 x 20</p>  <p><u>O/E numbers</u> Fiat 406409630 / 60812197</p> <p><u>Cross References</u> Fram CF5823 Mann CU3942 Micronair MP050 Purflux AH110/AH121 Tecnocar E314 Fiaam PC8013</p>	<p>CK 5823-C 385 x 173 x 20</p>  <p><u>O/E numbers</u> Fiat 46721923</p> <p><u>Cross References</u> Fram CFA8881 Mann..... Micronair MC550 Purflux..... Tecnocar..... Fiaam PCK8070</p>
--	---	---	---

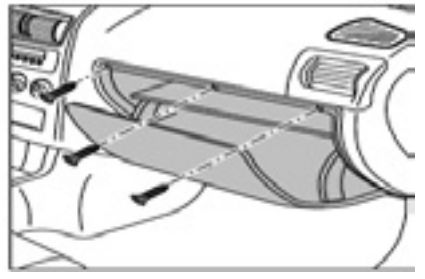
<p>--- Tipo ---</p> 	<p>07/87 -> 04/95 * <input type="checkbox"/></p>	<p>CK 5823 385 x 173 x 20</p>  <p><u>O/E numbers</u> Fiat 406409630 / 60812197</p> <p><u>Cross References</u> Fram CF5823 Mann CU3942 Micronair MP050 Purflux AH110/AH121 Tecnocar E314 Fiaam PC8013</p>	<p>CK 5823-C 385 x 173 x 20</p>  <p><u>O/E numbers</u> Fiat 46721923</p> <p><u>Cross References</u> Fram CFA8881 Mann..... Micronair MC550 Purflux..... Tecnocar..... Fiaam PCK8070</p>
--	---	---	---

<p>--- Tipo / Aegea ---</p> 	<p>11/15 -> * <input type="checkbox"/></p>	<p>CK 10413-10 199 x 177,5 x 30</p>  <p><u>O/E numbers</u> Fiat 77364561</p> <p><u>Cross References</u> Fram CF10413 Mann CU2040 Micronair MP283 Purflux AH265 Tecnocar Fiaam PC8200</p>	<p>---</p>
--	---	---	------------

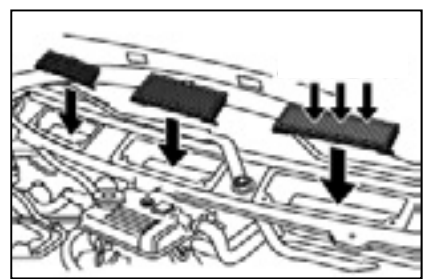
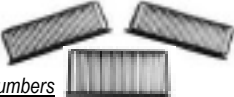

<p>--- Ulysse I (220) ---</p> 	<p>06/94 -> 08/02 * <input type="checkbox"/></p>	<p>CK 8947-3 1) 194 x 94/86 x 33 2) 194 x 67/64 x 33</p>  <p><u>O/E numbers</u> Fiat 1475478080 / 1475479080</p> <p><u>Cross References</u> Fram CF8947/CF8948 Mann CU19000-3 Micronair MP087-3 Purflux AH112/AH113 Tecnocar E315/E316 Fiaam PC8055/PC8056</p>	<p>---</p>
--	---	---	------------





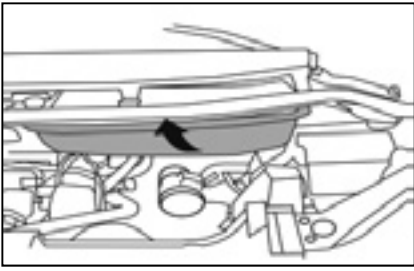

Anti-pollen

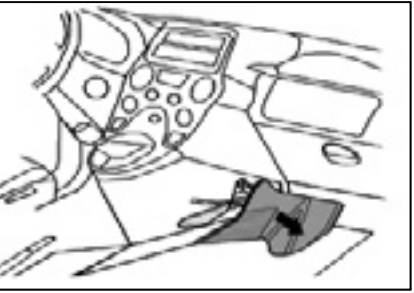

Activated carbon

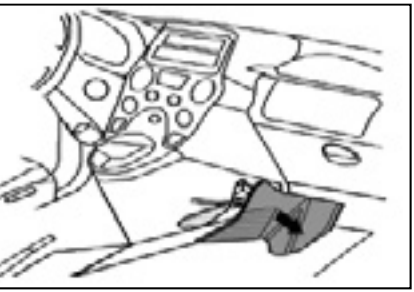

FIAT

<p>--- Ulysse II (179) ---</p>  <p> ① Il filtro è posizionato nel vano motore sul lato passeggero ② The filter is located in the engine compartment on the passenger's side ③ Le filtre est situé dans le compartiment moteur du côté passager ④ Der filter befindet sich Motorraum auf der Beifahrerseite ⑤ El filtro se encuentra en el compartimiento del motor, del lado del acompañante </p>	<p>08/02 -> * </p>	<p>CK 9586 405 x 164 x 32</p>  <p><u>O/E numbers</u> Fiat 1484383080 <u>Cross References</u> Fram CF9586 Mann CU4179 Micronair MP116 Puflex AH205 Tecnocar E408 Fiaam PC8108</p>	<p>CK 9586-C 405 x 164 x 32</p>  <p><u>O/E numbers</u> Fiat 9655190480 <u>Cross References</u> Fram CFA10307 Mann CUK4179 Micronair MC616 Puflex AHC205 Tecnocar EC408 Fiaam PCK8190</p>
---	-----------------------	--	---

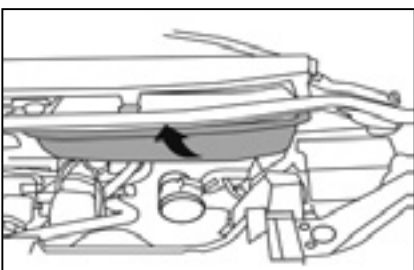
<p>--- 500 / Nuova 500 (150) ---</p>  <p> ① Il filtro è posizionato nell'abitacolo sotto il vano portaoggetti ② The filter is located in the passenger compartment under the glove compartment ③ Le filtre est situé dans l'habitacle en dessous de la boîte à gants ④ Der filter befindet sich im Fahrgastraum unter dem Handshuhfach ⑤ El filtro se encuentra en el habitáculo, bajo la guanterain de pasajerruimte </p>	<p>07/07 -> 08/11 * </p>	<p>CK 10025 202 x 176 x 18</p>  <p><u>O/E numbers</u> Fiat 46723321 <u>Cross References</u> Fram CF10025 Mann CU2026 Micronair MP163 Puflex AH233 Tecnocar E432 Fiaam PC8159</p>	<p>CK 10025-C 202 x 176 x 18</p>  <p><u>O/E numbers</u> Fiat 77365763 <u>Cross References</u> Fram Mann CUK2026 Micronair MC663 Puflex Tecnocar Fiaam</p>
--	-----------------------------	--	--

<p>--- 500 / Nuova 500 (150) ---</p>  <p> ① Il filtro è posizionato nell'abitacolo sotto il vano portaoggetti ② The filter is located in the passenger compartment under the glove compartment ③ Le filtre est situé dans l'habitacle en dessous de la boîte à gants ④ Der filter befindet sich im Fahrgastraum unter dem Handshuhfach ⑤ El filtro se encuentra en el habitáculo, bajo la guanterain de pasajerruimte </p>	<p>09/11 -> * </p>	<p>CK 20006 194 x 188 x 30</p>  <p><u>O/E numbers</u> Fiat 51854923 <u>Cross References</u> Fram CF11470 Mann CU20006 Micronair MP412 Puflex AH371 Tecnocar E665 Fiaam PC8340</p>	<p>CK 20006-C 194 x 188 x 30</p>  <p><u>O/E numbers</u> Fiat 71775823 <u>Cross References</u> Fram Mann CUK20006 Micronair Puflex Tecnocar Fiaam</p>
--	-----------------------	---	---

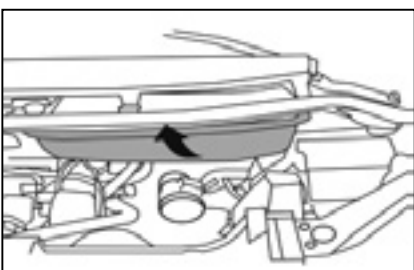
<p>--- 500L ---</p>  <p> ① Il filtro è posizionato nel vano motore sul lato passeggero ② The filter is located in the engine compartment on the passenger's side ③ Le filtre est situé dans le compartiment moteur du côté passager ④ Der filter befindet sich Motorraum auf der Beifahrerseite ⑤ El filtro se encuentra en el compartimiento del motor, del lado del acompañante </p>	<p>07/12 -> * </p>	<p>CK 77366480 219 x 156,5 x 29,5</p>  <p><u>O/E numbers</u> Fiat 77366480 <u>Cross References</u> Fram CF11662 Mann CU22022 Micronair MP440 Puflex AH396 Tecnocar E687 Fiaam PC8365</p>	<p>CK 77366480-C 405 x 164 x 32</p>  <p><u>O/E numbers</u> Fiat 71775824 <u>Cross References</u> Fram CFA11662 Mann CUK22022 Micronair Puflex AHC396 Tecnocar EC687 Fiaam PCK8365</p>
--	-----------------------	--	--

<p>--- 500X ---</p>  <p> ① Il filtro è posizionato nel vano motore sul lato passeggero ② The filter is located in the engine compartment on the passenger's side ③ Le filtre est situé dans le compartiment moteur du côté passager ④ Der filter befindet sich Motorraum auf der Beifahrerseite ⑤ El filtro se encuentra en el compartimiento del motor, del lado del acompañante </p>	<p>07/12 -> * </p>	<p>CK 77366480 219 x 156,5 x 29,5</p>  <p><u>O/E numbers</u> Fiat 77366480 <u>Cross References</u> Fram CF11662 Mann CU22022 Micronair MP440 Puflex AH396 Tecnocar E687 Fiaam PC8365</p>	<p>CK 77366480-C 405 x 164 x 32</p>  <p><u>O/E numbers</u> Fiat 71775824 <u>Cross References</u> Fram CFA11662 Mann CUK22022 Micronair Puflex AHC396 Tecnocar EC687 Fiaam PCK8365</p>
--	-----------------------	--	--



Anti-pollen

Activated carbon

FORD

--- B-Max ---

09/12 ->

*



- I** Il filtro è posizionato nell'abitacolo sotto il vano portaoggetti
- GB** The filter is located in the passenger compartment under the glove compartment
- F** Le filtre est situé dans l'habitacle en dessous de la boîte à gants
- D** Der filter befindet sich im Fahrgastraum unter dem Handshuhfach
- E** El filtro se encuentra en el habitáculo, bajo la guanterain de passajgeruimte

CK 2436-10

238 x 190 x 22



O/E numbers

Ford 1541456 / 1594615

Cross References

Fram CF10659 Mann CU2436
Micronair MP352 Purflux AH282
Tecocar E497 Fiaam PC8250

--- Bantam ---

09/01 ->

*

*

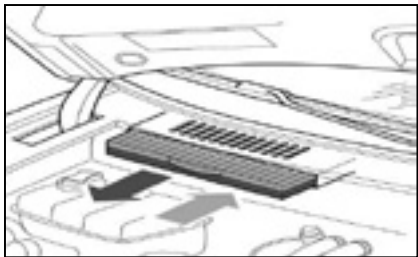

- I** Il filtro è posizionato nel vano motore sul lato passeggero
- GB** The filter is located in the engine compartment on the passenger's side
- F** Le filtre est situé dans le compartiment moteur du côté passager
- D** Der filter befindet sich Motorraum auf der Beifahrerseite
- E** El filtro se encuentra en el compartimiento del motor, del lado del acompañante

CK 5817

354/339 x 161/146 x 29



O/E numbers

Ford 1004051 / 96FW-16N-619-AB

Cross References

Fram CF5817 Man CU3554
Micronair MP017 Purflux AH122
Tecocar E323 Fiaam PC8012

CK 5817-C

354/339 x 161/145 x 29



O/E numbers

Ford 1120475 / 96FW-19G-244-AA

Cross References

Fram CFA9623 Mann CUK3554
Micronair MC517 Purflux AHC122
Tecocar EC323 Fiaam PCK8122

--- C-Max I ---

05/07 -> 08/10

*

*

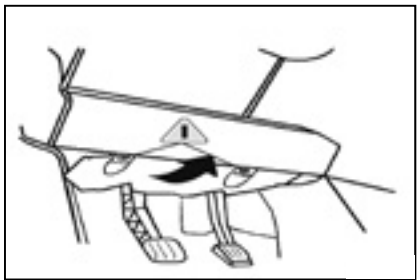

- I** Il filtro è posizionato nell'abitacolo sul lato conducente
- GB** The filter is located in the passenger compartment on the driver's side
- F** Le filtre est situé dans l'habitacle du côté conducteur
- D** Der Filter befindet sich im Fahrgastraum auf der Fahrerseite
- E** El Filtro se encuentra en el habitáculo, del lado del conductor

CK 9787

240 x 210 x 35



O/E numbers

Ford 1315686 / 3M5J-18D543-BA

Cross References

Fram CF9787 Mann CU2559
Micronair MP142 Purflux AH212
Tecocar E416 Fiaam PC8139

CK 9787-C

240 x 210 x 35



O/E numbers

Ford 1615687 / 3M5J-19G244-AA

Cross References

Fram CFA10584 Mann CUK2559
Micronair MC642 Purflux AHC212
Tecocar EC416 Fiaam PCK8219

--- C-Max II ---

09/10 ->

*

*

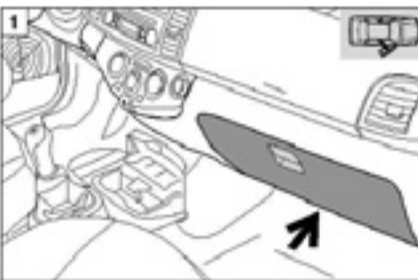

- I** Il filtro è posizionato nell'abitacolo sul lato conducente
- GB** The filter is located in the passenger compartment on the driver's side
- F** Le filtre est situé dans l'habitacle du côté conducteur
- D** Der Filter befindet sich im Fahrgastraum auf der Fahrerseite
- E** El Filtro se encuentra en el habitáculo, del lado del conductor

CK 25007

256 x 203,5 x 35



O/E numbers

Ford 5128504

Cross References

Fram CF11661 Mann CU25007
Micronair Purflux AH395
Tecocar Fiaam PC8364

CK 25007-C

256 x 203,5 x 35



O/E numbers

Ford 1709013 / AV6N19G244AA / 1776360

Cross References

Fram CFA11642 Mann CUK25007
Micronair Purflux AHC391
Tecocar EC682 Fiaam PCK8360

--- Cougar ---

01/99 -> 04/02

*

*

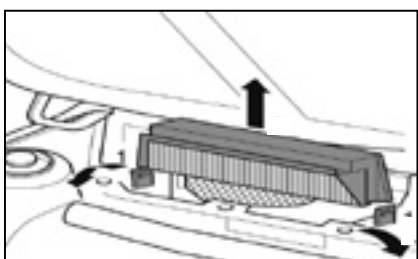

- I** Il filtro è posizionato nel vano motore sul lato passeggero
- GB** The filter is located in the engine compartment on the passenger's side
- F** Le filtre est situé dans le compartiment moteur du côté passager
- D** Der filter befindet sich Motorraum auf der Beifahrerseite
- E** El filtro se encuentra en el compartimiento del motor, del lado del acompañante

CK 5664

515/505 x 108/98 x 29,5/34,5



O/E numbers

Ford 1097670 / 1119613 / 7180932

Cross References

Fram CF5664/CF9534 Mann CU5257/CU5141
Micronair MP076/MP097 Purflux AH103
Tecocar E312 Fiaam PC8006/PC8099

CK 5664-C

514/504 x 108/98 x 29,5/36



O/E numbers

Ford 1132445 / 1225788 / 1115650

Cross References

Fram CFA8046/CFA9534 Mann CUK5257/CUK5141
Micronair MC576/MC597 Purflux AHC103
Tecocar Fiaam PCK8063/PCK8099



Anti-pollen

Activated carbon

FORD

--- Ecosport ---

08/12 ->

*



- I** Il filtro è posizionato nell'abitacolo sotto il vano portaoggetti
- GB** The filter is located in the passenger compartment under the glove compartment
- F** Le filtre est situé dans l'habitacle en dessous de la boîte à gants
- D** Der filter befindet sich im Fahrgastraum unter dem Handschuhfach
- E** El filtro se encuentra en el habitáculo, bajo la guantera de pasajerruimte

CK 2436-10

238 x 190 x 22



O/E numbers

Ford 1541456 / 1594615

Cross References

Fram CF10659 Mann CU2436
Micronair MP352 Purflux AH282
Tecnicar E497 Fiaam PC8250

--- Fiesta IV ---

06/95 -> 04/02

*

*

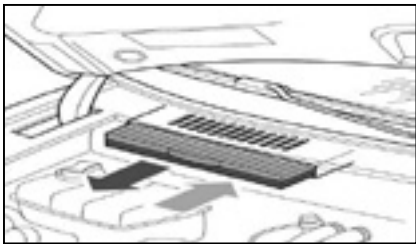

- I** Il filtro è posizionato nel vano motore sul lato passeggero
- GB** The filter is located in the engine compartment on the passenger's side
- F** Le filtre est situé dans le compartiment moteur du côté passager
- D** Der filter befindet sich Motorraum auf der Beifahrerseite
- E** El filtro se encuentra en el compartimiento del motor, del lado del acompañante

CK 5817

354/339 x 161/146 x 29



O/E numbers

Ford 1004051 / 96FW-16N-619-AB

Cross References

Fram CF5817 Man CU3554
Micronair MP017 Purflux AH122
Tecnicar E323 Fiaam PC8012

CK 5817-C

354/339 x 161/145 x 29



O/E numbers

Ford 1120475 / 96FW-19G-244-AA

Cross References

Fram CFA9623 Mann CUK3554
Micronair MC517 Purflux AHC122
Tecnicar EC323 Fiaam PCK8122

--- Fiesta V ---

04/02 ->

*

*

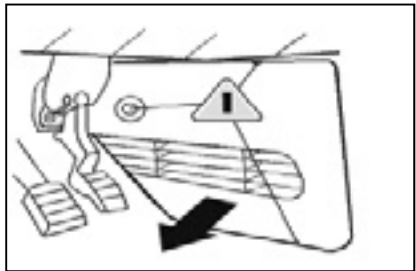

- I** Il filtro è posizionato nell'abitacolo sul lato conducente
- GB** The filter is located in the passenger compartment on the driver's side
- F** Le filtre est situé dans l'habitacle du côté conducteur
- D** Der Filter befindet sich im Fahrgastraum auf der Fahrerseite
- E** El Filtro se encuentra en el habitáculo, del lado del conductor

CK 9666

238 x 189 x 34,5



O/E numbers

Ford 1204459

Cross References

Fram CF9666 Mann CU2433
Micronair MP114 Purflux AH195
Tecnicar E452 Fiaam PC8124

CK 9666-C

238 x 189 x 34,5



O/E numbers

Ford 1204464 / 1353269

Cross References

Fram CFA9666 Mann CUK2433
Micronair MC614 Purflux AHC195
Tecnicar EC398 Fiaam PCK8124

--- Fiesta VI ---

10/08 ->

*



- Il filtro è posizionato nell'abitacolo sotto il vano portaoggetti
- The filter is located in the passenger compartment under the glove compartment
- Le filtre est situé dans l'habitacle en dessous de la boîte à gants
- Der filter befindet sich im Fahrgastraum unter dem Handschuhfach
- El filtro se encuentra en el habitáculo, bajo la guantera de pasajerruimte

CK 2436-10

238 x 190 x 22



O/E numbers

Ford 1541456 / 1594615

Cross References

Fram CF10659 Mann CU2436
Micronair MP352 Purflux AH282
Tecnicar..... Fiaam PC8250

--- Fiesta Courier II ---

02/96 ->

*

*



- I** Il filtro è posizionato nel vano motore sul lato passeggero
- GB** The filter is located in the engine compartment on the passenger's side
- F** Le filtre est situé dans le compartiment moteur du côté passager
- D** Der filter befindet sich Motorraum auf der Beifahrerseite
- E** El filtro se encuentra en el compartimiento del motor, del lado del acompañante

CK 5817

354/339 x 161/146 x 29



O/E numbers

Ford 1004051 / 96FW-16N-619-AB

Cross References

Fram CF5817 Man CU3554
Micronair MP017 Purflux AH122
Tecnicar E323 Fiaam PC8012

CK 5817-C

354/339 x 161/145 x 29



O/E numbers

Ford 1120475 / 96FW-19G-244-AA

Cross References

Fram CFA9623 Mann CUK3554
Micronair MC517 Purflux AHC122
Tecnicar EC323 Fiaam PCK8122



Anti-pollen

Activated carbon

FORD

--- Focus I ---

10/98 -> 11/04

*

*

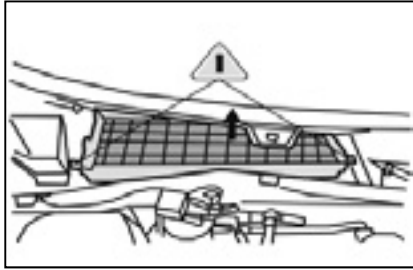

- I** Il filtro è posizionato nel vano motore sul lato passeggero sotto il coperchio della vaschetta del radiatore
- GB** The filter is located in the engine compartment on the passenger's side under the radiator tank cover
- F** Le filtre est situé dans le compartiment moteur du côté passager en dessous du cache du réservoir à eau
- D** Der filter befindet sich Motorraum auf der Beifahrerseite unter der Wasserkastenabdeckung
- E** El filtro se encuentra en el compartimiento del motor, lado del acompañante, bajo la cubierta del depósito del agua

CK 8831

350 x 163 x 30



O/E numbers

Ford 1062253 / XS4H-16N-619-AB

Cross References

Fram CF8831 Mann CU3567
Micronair MP041 Purflux AH167
Tecocar E363 Fiaam PC8043

CK 8831-C

350 x 163 x 30



O/E numbers

Ford 1139654 / 12121106

Cross References

Fram CFA8831 Mann CUK3567
Micronair MC541 Purflux AHC167
Tecocar EC363 Fiaam PCK8043

--- Focus II ---

11/04 ->

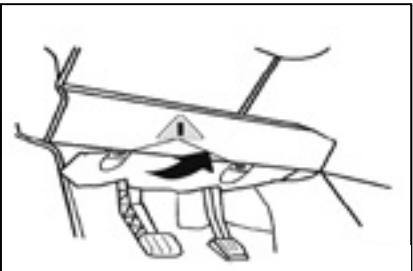

- I** Il filtro è posizionato nell'abitacolo sul lato conducente
- GB** The filter is located in the passenger compartment on the driver's side
- F** Le filtre est situé dans l'habitacle du côté conducteur
- D** Der Filter befindet sich im Fahrgastraum auf der Fahrerseite
- E** El Filtro se encuentra en el habitáculo, del lado del conductor

CK 10059

233 x 209 x 35



O/E numbers

Ford 1354952

Cross References

Fram CF10059 Mann CU2440
Micronair MP145/MP181 Purflux AH238
Tecocar E442 Fiaam PC8161

CK 10059-C

233 x 209 x 35



O/E numbers

Ford 1354953 / 4M5J-19G244-AA

Cross References

Fram CFA10527 Mann CUK2440
Micronair MC645/MC681 Purflux ACH238
Tecocar EC484 Fiaam PCK8214

--- Focus III ---

03/11 ->

*

*

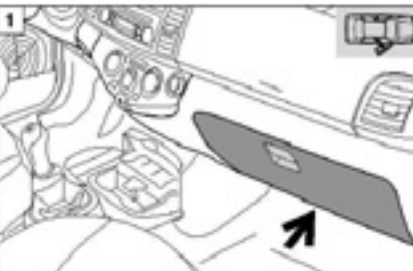

- I** Il filtro è posizionato nell'abitacolo sul lato conducente
- GB** The filter is located in the passenger compartment on the driver's side
- F** Le filtre est situé dans l'habitacle du côté conducteur
- D** Der Filter befindet sich im Fahrgastraum auf der Fahrerseite
- E** El Filtro se encuentra en el habitáculo, del lado del conductor

CK 25007

256 x 203,5 x 35



O/E numbers

Ford 5128504

Cross References

Fram CF11661 Mann CU25007
Micronair Purflux AH395
Tecocar Fiaam PC8364

CK 25007-C

256 x 203,5 x 35



O/E numbers

Ford 1709013 / AV6N19G244AA / 1776360

Cross References

Fram CFA11642 Mann CUK25007
Micronair Purflux AHC391
Tecocar EC682 Fiaam PCK8360

--- Focus Cabriolet ---

10/06 ->

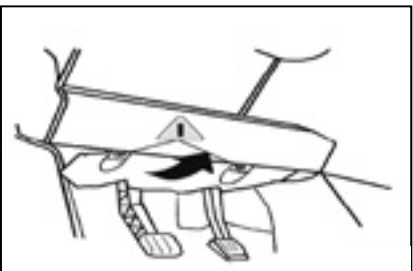

- I** Il filtro è posizionato nell'abitacolo sul lato conducente
- GB** The filter is located in the passenger compartment on the driver's side
- F** Le filtre est situé dans l'habitacle du côté conducteur
- D** Der Filter befindet sich im Fahrgastraum auf der Fahrerseite
- E** El Filtro se encuentra en el habitáculo, del lado del conductor

CK 10059

233 x 209 x 35



O/E numbers

Ford 1354952

Cross References

Fram CF10059 Mann CU2440
Micronair MP145/MP181 Purflux AH238
Tecocar E442 Fiaam PC8161

CK 10059-C

233 x 209 x 35



O/E numbers

Ford 1354953 / 4M5J-19G244-AA

Cross References

Fram CFA10527 Mann CUK2440
Micronair MC645/MC681 Purflux ACH238
Tecocar EC484 Fiaam PCK8214

--- Focus C-Max ---

10/03 ->

*

*

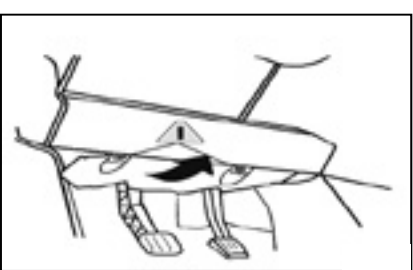

- I** Il filtro è posizionato nell'abitacolo sul lato conducente
- GB** The filter is located in the passenger compartment on the driver's side
- F** Le filtre est situé dans l'habitacle du côté conducteur
- D** Der Filter befindet sich im Fahrgastraum auf der Fahrerseite
- E** El Filtro se encuentra en el habitáculo, del lado del conductor

CK 9787

240 x 210 x 35



O/E numbers

Ford 1315686 / 3M5J-18D543-BA

Cross References

Fram CF9787 Mann CU2559
Micronair MP142 Purflux AH212
Tecocar E416 Fiaam PC8139

CK 9787-C

240 x 210 x 35



O/E numbers

Ford 1615687 / 3M5J-19G244-AA

Cross References

Fram CFA10584 Mann CUK2559
Micronair MC642 Purflux AHC212
Tecocar EC416 Fiaam PCK8219



Anti-pollen

Activated carbon

FORD

--- Fusion / Fusion Plus ---

08/02 ->

*

*

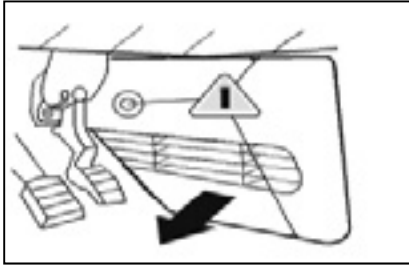

- I** Il filtro è posizionato nell'abitacolo sul lato conducente
- GB** The filter is located in the passenger compartment on the driver's side
- F** Le filtre est situé dans l'habitacle du côté conducteur
- D** Der Filter befindet sich im Fahrgastraum auf der Fahrerseite
- E** El Filtro se encuentra en el habitáculo, del lado del conductor

CK 9666

238 x 189 x 34,5



O/E numbers

Ford 1204459

Cross References

Fram CF9666 Mann CU2433
 Micronair MP114 Purflux.....
 Tecocar..... Fiaam PC8124

CK 9666-C

238 x 189 x 34,5



O/E numbers

Ford 1204464 / 1353269

Cross References

Fram CFA9666 Mann CUK2433
 Micronair MC614 Purflux AHC195
 Tecocar EC398 Fiaam PCK8124

--- Galaxy I ---

01/96 -> 05/06

*

*

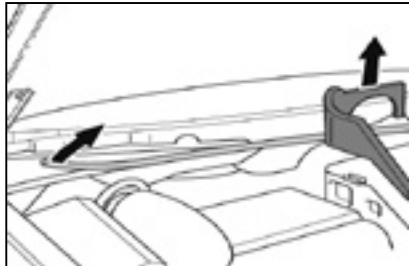

- I** Il filtro è posizionato nel vano motore sul lato passeggero
- GB** The filter is located in the engine compartment on the passenger's side
- F** Le filtre est situé dans le compartiment moteur du côté passager
- D** Der filter befindet sich Motorraum auf der Beifahrerseite
- E** El filtro se encuentra en el compartimiento del motor, del lado del acompañante

CK 5850

535 x 109 x 25,5



O/E numbers

Ford 1054468 / 7420372

Cross References

Fram CF5850 Mann CU5480
 Micronair MP025 Purflux AH129
 Tecocar E329 Fiaam PC8024

CK 5850-C

535 x 109,5 x 25,5



O/E numbers

Ford 1107351 / 1148366

Cross References

Fram CFA8878 Mann CUK5480
 Micronair MC525 Purflux AHC129
 Tecocar..... Fiaam PCK8066

--- Galaxy II ---

05/06 ->

*

*

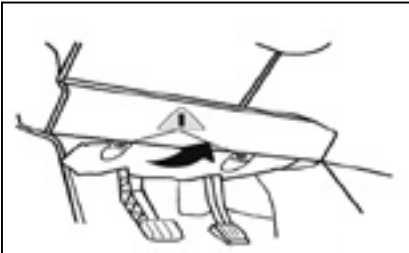

- I** Il filtro è posizionato nell'abitacolo sul lato conducente
- GB** The filter is located in the passenger compartment on the driver's side
- F** Le filtre est situé dans l'habitacle du côté conducteur
- D** Der Filter befindet sich im Fahrgastraum auf der Fahrerseite
- E** El Filtro se encuentra en el habitáculo, del lado del conductor

CK 9787

240 x 210 x 35



O/E numbers

Ford 1315686 / 3M5J-18D543-BA

Cross References

Fram CF9787 Mann CU2559
 Micronair MP142 Purflux AH212
 Tecocar E416 Fiaam PC8139

CK 9787-C

240 x 210 x 35



O/E numbers

Ford 1615687 / 3M5J-19G244-AA

Cross References

Fram CFA10584 Mann CUK2559
 Micronair MC642 Purflux AHC212
 Tecocar EC416 Fiaam PCK8219

--- Ka I ---

10/96 -> 12/08

*

*

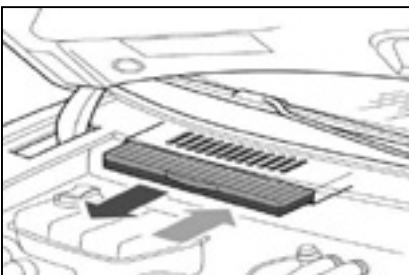

- I** Il filtro è posizionato nel vano motore dietro la presa d'aria
- GB** The filter is located in the engine compartment behind the ventilation grilles
- F** Le filtre est situé dans le compartiment moteur derrière les grilles d'aération
- D** Der filter befindet sich im Motorraum hinter den Lüftungsgittern
- E** El filtro se encuentra en el compartimiento del motor, detrás de la rejilla de ventilación

CK 5817

354/339 x 161/146 x 29



O/E numbers

Ford 1004051 / 96FW-16N-619-AB

Cross References

Fram CF5817 Mann CU3554
 Micronair MP017 Purflux AH122
 Tecocar E323 Fiaam PC8012

CK 5817-C

354/339 x 161/145 x 29



O/E numbers

Ford 1120475 / 96FW-19G-244-AA

Cross References

Fram CFA9623 Mann CUK3554
 Micronair MC517 Purflux AHC122
 Tecocar EC323 Fiaam PCK8122

--- Ka II ---

12/08 ->

*

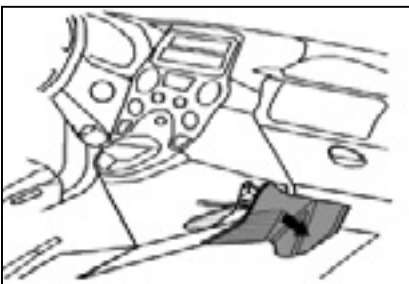

- I** Il filtro è posizionato nell'abitacolo sotto il vano portaoggetti
- GB** The filter is located in the passenger compartment under the glove compartment
- F** Le filtre est situé dans l'habitacle en dessous de la boîte à gants
- D** Der filter befindet sich im Fahrgastraum unter dem Handschuhfach
- E** El filtro se encuentra en el habitáculo, bajo la guantera de pasajero

CK 10025

202 x 176 x 18



O/E numbers

Ford 1557375 / 1751197

Cross References

Fram CF10025 Mann CU2026
 Micronair MP163 Purflux AH233
 Tecocar E432 Fiaam PC8159

CK 10025-C

202 x 176 x 18



O/E numbers

Ford 1673744

Cross References

Fram Mann CUK2026
 Micronair MC663 Purflux
 Tecocar Fiaam



Anno di fabbricazione / Year of construction
 Année de fabrication / Baujahr / Año de fabricación



Con climatizzatore / With air-conditioning / Avec climatisation
 Mit Klimaanlage / Con instalación de aire acondicionado



Senza climatizzatore / Without air-conditioning / Sans climatisation
 Ohne Klimaanlage / Sin instalación de aire acondicionado



Anti-pollen

Activated carbon

FORD

--- Kuga ---

11/08 ->

*

*

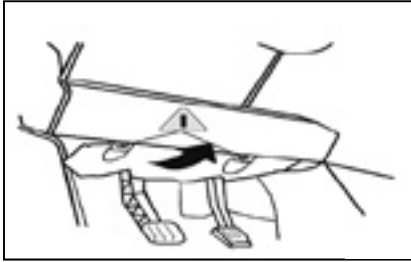

- I** Il filtro è posizionato nell'abitacolo sul lato conducente
- GB** The filter is located in the passenger compartment on the driver's side
- F** Le filtre est situé dans l'habitacle du côté conducteur
- D** Der Filter befindet sich im Fahrgastraum auf der Fahrerseite
- E** El Filtro se encuentra en el habitáculo, del lado del conductor

CK 9787

240 x 210 x 35



O/E numbers

Ford 1315686 / 3M5J-18D543-BA

Cross References

Fram CF9787 Mann CU2559
Micronair MP142 Purflux AH212
Tecocar E416 Fiaam PC8139

CK 9787-C

240 x 210 x 35



O/E numbers

Ford 1615687 / 3M5J-19G244-AA

Cross References

Fram CFA10584 Mann CUK2559
Micronair MC642 Purflux AHC212
Tecocar EC416 Fiaam PCK8219

--- Kuga II ---

02/13 ->

*

*

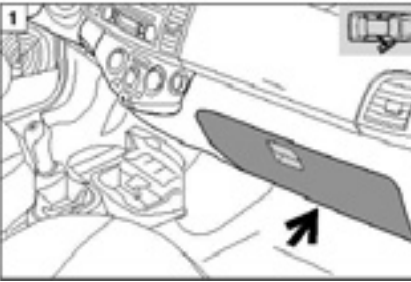

- I** Il filtro è posizionato nell'abitacolo sul lato conducente
- GB** The filter is located in the passenger compartment on the driver's side
- F** Le filtre est situé dans l'habitacle du côté conducteur
- D** Der Filter befindet sich im Fahrgastraum auf der Fahrerseite
- E** El Filtro se encuentra en el habitáculo, del lado del conductor

CK 25007

256 x 203,5 x 35



O/E numbers

Ford 5128504

Cross References

Fram CF11661 Mann CU25007
Micronair Purflux AH395
Tecocar Fiaam PC8364

CK 25007-C

256 x 203,5 x 35



O/E numbers

Ford 1709013 / AV6N19G244AA / 1776360

Cross References

Fram CFA11642 Mann CUK25007
Micronair Purflux AHC391
Tecocar EC682 Fiaam PCK8360

--- Maverick I ---

02/93 -> 11/00

*

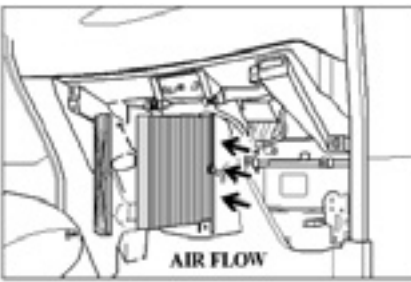

- I** Il filtro è posizionato nell'abitacolo dietro il vano portaoggetti
- GB** The filter is located in the passenger compartment behind the glove compartment
- F** Le filtre est situé dans l'habitacle derrière la boîte à gants
- D** Der filter befindet sich im Fahrgastraum hinter dem Handschuhfach
- E** El filtro se encuentra en el habitáculo detrás de la guantera

CK 9337

258 x 194 x 20



O/E numbers

Ford 5028225 / 5028226 / 5029916

Cross References

Fram CF9337 Mann CU2530
Micronair MP082 Purflux AH225
Tecocar E424 Fiaam PC8081

--- Mondeo I+II ---

02/93 -> 11/00

*

*

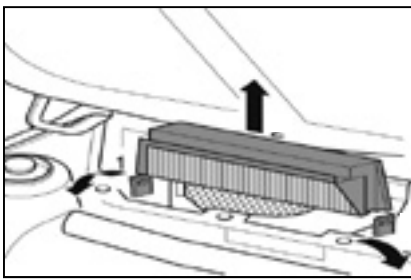

- I** Il filtro è posizionato nel vano motore sul lato passeggero
- GB** The filter is located in the engine compartment on the passenger's side
- F** Le filtre est situé dans le compartiment moteur du côté passager
- D** Der filter befindet sich Motorraum auf der Beifahrerseite
- E** El filtro se encuentra en el compartimiento del motor, del lado del acompañante

CK 5664

515/505 x 108/98 x 29,5/34,5



O/E numbers

Ford 1097670 / 1119613 / 7180932

Cross References

Fram CF5664/CF9534 Mann CU5257/CU5141
Micronair MP076/MP097 Purflux AH103
Tecocar E312 Fiaam PC8006/PC8099

CK 5664-C

514/504 x 108/98 x 29,5/36



O/E numbers

Ford 1132445 / 1225788 / 1115650

Cross References

Fram CFA8046/CFA9534 Mann CU5257/CUK5141
Micronair MC576/MC597 Purflux AHC103
Tecocar..... Fiaam PCK8063/PCK8099

--- Mondeo III ---

11/00 ->

*

*

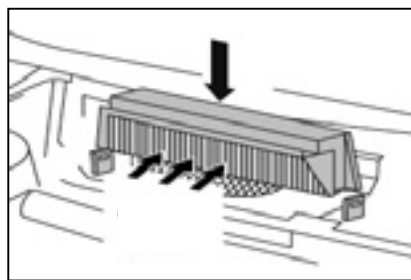

- I** Il filtro è posizionato nel vano motore sul lato passeggero sotto il coperchio della vaschetta del radiatore
- GB** The filter is located in the engine compartment on the passenger's side under the radiator tank cover
- F** Le filtre est situé dans le compartiment moteur du côté passager en dessous du cache du réservoir à eau
- D** Der filter befindet sich Motorraum auf der Beifahrerseite unter der Wasserkastenabdeckung
- E** El filtro se encuentra en el compartimiento del motor, lado del acompañante, bajo la cubierta del depósito del agua

CK 5664

515/505 x 108/98 x 29,5/34,5



O/E numbers

Ford 1097670 / 1119613 / 7180932

Cross References

Fram CF5664/CF9534 Mann CU5257/CU5141
Micronair MP076/MP097 Purflux AH103
Tecocar E312 Fiaam PC8006/PC8099

CK 5664-C

514/504 x 108/98 x 29,5/36



O/E numbers

Ford 1132445 / 1225788 / 1115650

Cross References

Fram CFA8046/CFA9534 Mann CU5257/CUK5141
Micronair MC576/MC597 Purflux AHC103
Tecocar..... Fiaam PCK8063/PCK8099



Anti-pollen

Activated carbon

FORD

--- Mondeo IV ---

04/07 ->

*

*

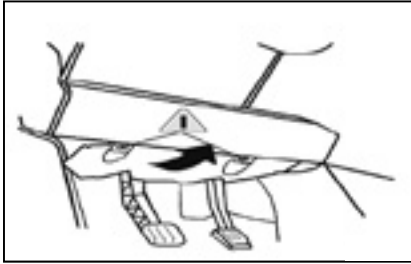

- I** Il filtro è posizionato nell'abitacolo sul lato conducente
- GB** The filter is located in the passenger compartment on the driver's side
- F** Le filtre est situé dans l'habitacle du côté conducteur
- D** Der Filter befindet sich im Fahrgastraum auf der Fahrerseite
- E** El Filtro se encuentra en el habitáculo, del lado del conductor

CK 9787

240 x 210 x 35



O/E numbers

Ford 1315686 / 3M5J-18D543-BA

Cross References

Fram CF9787 Mann CU2559
Micronair MP142 Purflux AH212
Tecocar E416 Fiaam PC8139

CK 9787-C

240 x 210 x 35



O/E numbers

Ford 1615687 / 3M5J-19G244-AA

Cross References

Fram CFA10584 Mann CUK2559
Micronair MC642 Purflux AHC212
Tecocar EC416 Fiaam PCK8219

--- Puma ---

10/97 -> 09/02

*

*

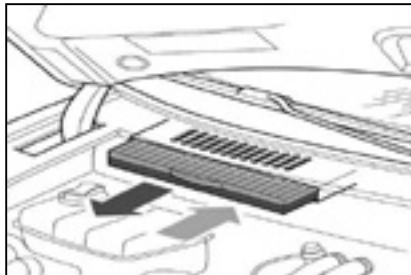

- I** Il filtro è posizionato nel vano motore dietro la presa d'aria
- GB** The filter is located in the engine compartment behind the ventilation grilles
- F** Le filtre est situé dans le compartiment moteur derrière les grilles d'aération
- D** Der filter befindet sich im Motorraum hinter den Lüftungsgittern
- E** El filtro se encuentra en el compartimiento del motor, detrás de la rejilla de ventilación

CK 5817

354/339 x 161/146 x 29



O/E numbers

Ford 1004051 / 96FW-16N-619-AB

Cross References

Fram CF5817 Mann CU3554
Micronair MP017 Purflux AH122
Tecocar E323 Fiaam PC8012

CK 5817-C

354/339 x 161/146 x 29



O/E numbers

Ford 1120475 / 96FW-19G-244-AA

Cross References

Fram CFA9623 Mann CUK3554
Micronair MC517 Purflux AHC122
Tecocar EC323 Fiaam PCK8122

--- S-Max ---

05/06 ->

*

*

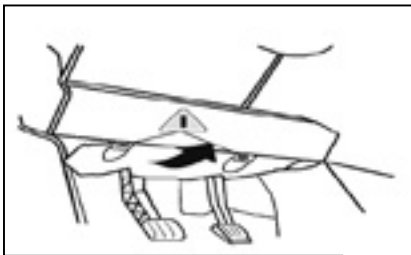

- I** Il filtro è posizionato nell'abitacolo sul lato conducente
- GB** The filter is located in the passenger compartment on the driver's side
- F** Le filtre est situé dans l'habitacle du côté conducteur
- D** Der Filter befindet sich im Fahrgastraum auf der Fahrerseite
- E** El Filtro se encuentra en el habitáculo, del lado del conductor

CK 9787

240 x 210 x 35



O/E numbers

Ford 1315686 / 3M5J-18D543-BA

Cross References

Fram CF9787 Mann CU2559
Micronair MP142 Purflux AH212
Tecocar E416 Fiaam PC8139

CK 9787-C

240 x 210 x 35



O/E numbers

Ford 1615687 / 3M5J-19G244-AA

Cross References

Fram CFA10584 Mann CUK2559
Micronair MC642 Purflux AHC212
Tecocar EC416 Fiaam PCK8219

--- Scorpio ---

10/94 ->

*

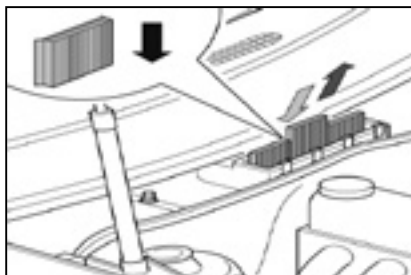

- I** Il filtro è posizionato nel vano motore, nel gruppo riscaldatore (climatizzatore)
- GB** The filter is located in the engine compartment at the heater (air-conditioner)
- F** Le filtre est situé dans le compartiment moteur sur le circuit de chauffage (la climatisation)
- D** Der Filter befindet sich im Motorraum beim Heizungssystem (Klimaanlage)
- E** El filtro se encuentra en el compartimiento del motor, en el sistema de calefacción (la instalación de aire acondicionado)

CK 5852-3

139/123 x 109 x 20



O/E numbers

Ford 1054491 / 95GX-18N-405-AC

Cross References

Fram CF5852 Mann CU1313-3
Micronair MP006-3 Purflux AH123
Tecocar E324 Fiaam PC8026

--- Tourneo Connect ---

09/02 ->

*

*

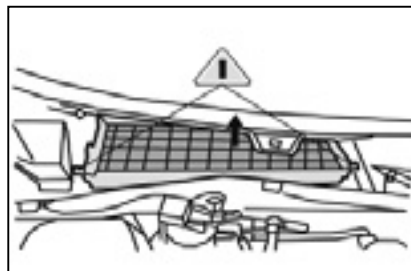

- I** Il filtro è posizionato nel vano motore sul lato passeggero sotto il coperchio della vaschetta del radiatore
- GB** The filter is located in the engine compartment on the passenger's side under the radiator tank cover
- F** Le filtre est situé dans le compartiment moteur du côté passager en dessous du cache du réservoir à eau
- D** Der filter befindet sich Motorraum auf der Beifahrerseite unter der Wasserkastenabdeckung
- E** El filtro se encuentra en el compartimiento del motor, lado del acompañante, bajo la cubierta del depósito del agua

CK 8831

350 x 163 x 30



O/E numbers

Ford 1062253 / XS4H-16N-619-AB

Cross References

Fram CF8831 Mann CU3567
Micronair MP041 Purflux AH167
Tecocar E363 Fiaam PC8043

CK 8831-C

350 x 163 x 30



O/E numbers

Ford 1139654 / 12121106

Cross References

Fram CFA8831 Mann CUK3567
Micronair MC541 Purflux AHC167
Tecocar EC363 Fiaam PCK8043



Anti-pollen

Activated carbon

FORD

--- Tourneo Connect II ---

12/13 ->

*

*

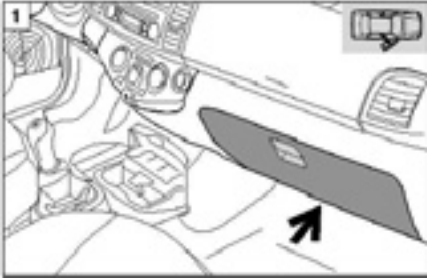

- I** Il filtro è posizionato nell'abitacolo sul lato conducente
- GB** The filter is located in the passenger compartment on the driver's side
- F** Le filtre est situé dans l'habitacle du côté conducteur
- D** Der Filter befindet sich im Fahrgastraum auf der Fahrerseite
- E** El Filtro se encuentra en el habitáculo, del lado del conductor

CK 25007

256 x 203,5 x 35



O/E numbers

Ford 5128504

Cross References

Fram CF11661 Mann CU25007
 Micronair Purflux AH395
 Tecocar Fiaam PC8364

CK 25007-C

256 x 203,5 x 35



O/E numbers

Ford 1709013 / AV6N19G244AA / 1776360

Cross References

Fram CFA11642 Mann CUK25007
 Micronair Purflux AHC391
 Tecocar EC682 Fiaam PCK8360

--- Tourneo Custom 2012 ---

09/13 ->

*

*



- I** Il filtro è posizionato nell'abitacolo sul lato conducente
- GB** The filter is located in the passenger compartment on the driver's side
- F** Le filtre est situé dans l'habitacle du côté conducteur
- D** Der Filter befindet sich im Fahrgastraum auf der Fahrerseite
- E** El Filtro se encuentra en el habitáculo, del lado del conductor

CK 11743

284 x 232 x 30



O/E numbers

Ford 1812 679 / BK2118D543AA

Cross References

Fram CF11743 Mann CU29007
 Micronair MP442 Purflux AH412
 Tecocar E703 Fiaam PC8382

--- Transit 2000 ---

01/00 -> 07/06

*

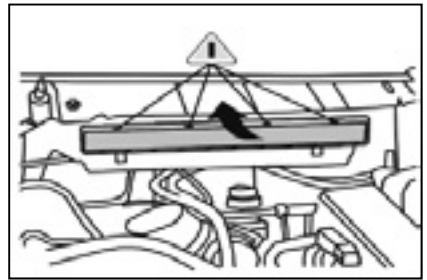

- I** Il filtro è posizionato nel vano motore al centro
- GB** The filter is located in the engine compartment centrally
- F** Le filtre est situé dans le compartiment moteur au centre
- D** Der Filter befindet sich im Motorraum mittig
- E** El filtro se encuentra en el compartimiento del motor, en el centro

CK 9485

353 x 125 x 25



O/E numbers

Ford 4042703 / YC1H-19N-619-AB

Cross References

Fram CF9485 Mann CU3649
 Micronair MP101 Purflux AH224
 Tecocar E431 Fiaam PC8098

--- Transit 2007 ---

07/06 ->

*

*

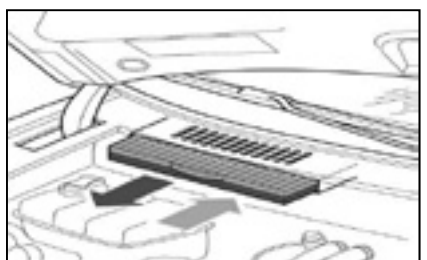

- I** Il filtro è posizionato nel vano motore sul lato passeggero
- GB** The filter is located in the engine compartment on the passenger's side
- F** Le filtre est situé dans le compartiment moteur du côté passager
- D** Der filter befindet sich Motorraum auf der Beifahrerseite
- E** El filtro se encuentra en el compartimiento del motor, del lado del acompañante

CK 22013

213 x 200 x 30



O/E numbers

Ford 1745604 / 1748480 / 8C1616N619A2A

Cross References

Fram CF11484 Mann CU22013
 Micronair MP425 Purflux AH376
 Tecocar E670 Fiaam PC8346

CK 22013-C

213 x 200 x 30



O/E numbers

Ford 1745605 / 1748479 / 6C1119G244AA

Cross References

Fram Mann CUK22013
 Micronair MC925 Purflux
 Tecocar Fiaam

--- Transit 2014 ---

01/14 ->

*

*



- I** Il filtro è posizionato nell'abitacolo sul lato conducente
- GB** The filter is located in the passenger compartment on the driver's side
- F** Le filtre est situé dans l'habitacle du côté conducteur
- D** Der Filter befindet sich im Fahrgastraum auf der Fahrerseite
- E** El Filtro se encuentra en el habitáculo, del lado del conductor

CK 11743

284 x 232 x 30



O/E numbers

Ford 1812 679 / BK2118D543AA

Cross References

Fram CF11743 Mann CU29007
 Micronair MP442 Purflux AH412
 Tecocar E703 Fiaam PC8382



Anti-pollen

Activated carbon

FORD

--- Transit Connect (TC7) ---

09/02 -> 12/13

*

*

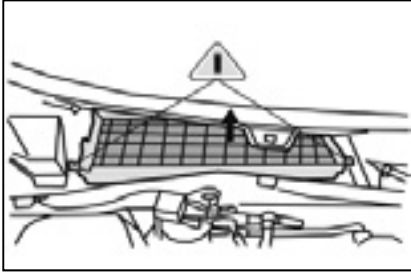

- I** Il filtro è posizionato nel vano motore sul lato passeggero sotto il coperchio della vaschetta del radiatore
- GB** The filter is located in the engine compartment on the passenger's side under the radiator tank cover
- F** Le filtre est situé dans le compartiment moteur du côté passager en dessous du cache du réservoir à eau
- D** Der filter befindet sich Motorraum auf der Beifahrerseite unter der Wasserkastenabdeckung
- E** El filtro se encuentra en el compartimiento del motor, lado del acompañante, bajo la cubierta del depósito del agua

CK 8831

350 x 163 x 30



O/E numbers

Ford 1062253 / XS4H-16N-619-AB

Cross References

Fram CF8831 Mann CU3567
Micronair MP041 Purflux AH167
Tecnicar E363 Fiaam PC8043

CK 8831-C

350 x 163 x 30



O/E numbers

Ford 1139654 / 12121106

Cross References

Fram CFA8831 Mann CUK3567
Micronair MC541 Purflux AHC167
Tecnicar EC363 Fiaam PCK8043

--- Transit Connect II (CHC) ---

12/13 ->

*

*

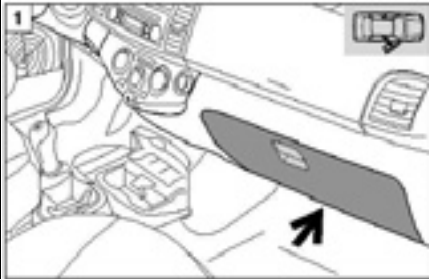

- I** Il filtro è posizionato nell'abitacolo sul lato conducente
- GB** The filter is located in the passenger compartment on the driver's side
- F** Le filtre est situé dans l'habitacle du côté conducteur
- D** Der Filter befindet sich im Fahrgastraum auf der Fahrerseite
- E** El Filtro se encuentra en el habitáculo, del lado del conductor

CK 25007

256 x 203,5 x 35



O/E numbers

Ford 5128504

Cross References

Fram CF11661 Mann CU25007
Micronair Purflux AH395
Tecnicar Fiaam PC8364

CK 25007-C

256 x 203,5 x 35



O/E numbers

Ford 1709013 / AV6N19G244AA / 1776360

Cross References

Fram CFA11642 Mann CUK25007
Micronair Purflux AHC391
Tecnicar EC682 Fiaam PCK8360

--- Transit Custom 2012 ---

09/12 ->

*

*



- I** Il filtro è posizionato nell'abitacolo sul lato conducente
- GB** The filter is located in the passenger compartment on the driver's side
- F** Le filtre est situé dans l'habitacle du côté conducteur
- D** Der Filter befindet sich im Fahrgastraum auf der Fahrerseite
- E** El Filtro se encuentra en el habitáculo, del lado del conductor

CK 11743

284 x 232 x 30



O/E numbers

Ford 1812 679 / BK2118D543AA

Cross References

Fram CF11743 Mann CU29007
Micronair MP442 Purflux AH412
Tecnicar E703 Fiaam PC8382

--- Transit / Tourneo Courier (C4A) ---

04/14 ->

*

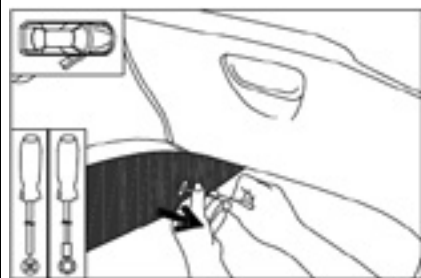

- Il filtro è posizionato nell'abitacolo sotto il vano portaoggetti
- The filter is located in the passenger compartment under the glove compartment
- Le filtre est situé dans l'habitacle en dessous de la boîte à gants
- Der filter befindet sich im Fahrgastraum unter dem Handschuhfach
- El filtro se encuentra en el habitáculo, bajo la guanterain de pasajerruimte

CK 2436-10

238 x 190 x 22



O/E numbers

Ford 1541456 / 1594615

Cross References

Fram CF10659 Mann CU2436
Micronair MP352 Purflux AH282
Tecnicar Fiaam PC8250



Anti-pollen

Activated carbon

HONDA

--- Accord VII ---

10/98 ->

*

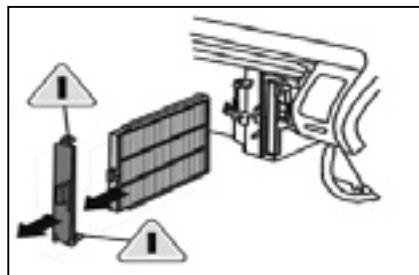

- I Il filtro è posizionato nell'abitacolo dietro il vano portaoggetti
- GB The filter is located in the passenger compartment behind the glove compartment
- F Le filtre est situé dans l'habitacle derrière la boîte à gants
- D Der filter befindet sich im Fahrgastraum hinter dem Handshuhfach
- E El filtro se encuentra en el habitáculo detrás de la guantera

CK 9399

276 x 200 x 17



O/E numbers

Honda 79370S1AG01 / H79370S1AG01

Cross References

Fram CF9399 Mann CU2839
Micronair MP079 Purflux AH214
Tecnocar E418 Fiaam PC8089

--- Accord VIII ---

01/03 ->

*

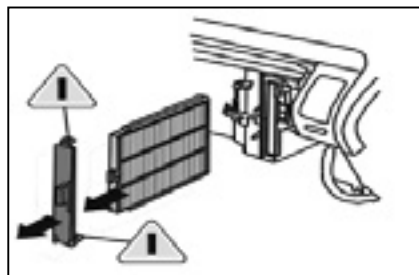

- I Il filtro è posizionato nell'abitacolo dietro il vano portaoggetti
- GB The filter is located in the passenger compartment behind the glove compartment
- F Le filtre est situé dans l'habitacle derrière la boîte à gants
- D Der filter befindet sich im Fahrgastraum hinter dem Handshuhfach
- E El filtro se encuentra en el habitáculo detrás de la guantera

CK 10062

237 x 244 x 35/51



telajo pvc / pvc frame

O/E numbers

Honda 80292SDCA01 / 80292SHJA41

Cross References

Fram CF10062 Mann CU2358
Micronair MP180 Purflux AH221
Tecnocar E422 Fiaam PC8166

--- Accord IX ---

06/08 ->

*

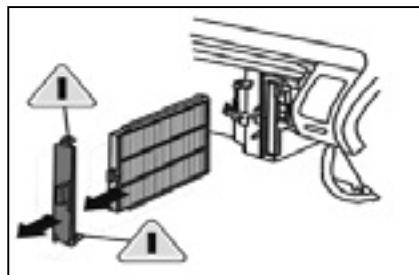

- I Il filtro è posizionato nell'abitacolo dietro il vano portaoggetti
- GB The filter is located in the passenger compartment behind the glove compartment
- F Le filtre est situé dans l'habitacle derrière la boîte à gants
- D Der filter befindet sich im Fahrgastraum hinter dem Handshuhfach
- E El filtro se encuentra en el habitáculo detrás de la guantera

CK 10062

237 x 244 x 35/51



telajo pvc / pvc frame

O/E numbers

Honda 80292SDCA01 / 80292SHJA41

Cross References

Fram CF10062 Mann CU2358
Micronair MP180 Purflux AH221
Tecnocar E422 Fiaam PC8166

--- Ballade ---

02/06 -> 12/13

*

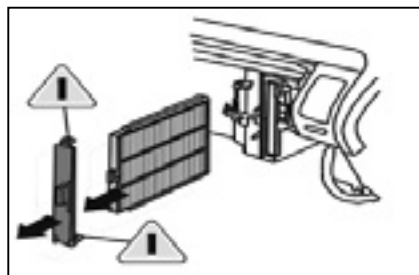

- I Il filtro è posizionato nell'abitacolo dietro il vano portaoggetti
- GB The filter is located in the passenger compartment behind the glove compartment
- F Le filtre est situé dans l'habitacle derrière la boîte à gants
- D Der filter befindet sich im Fahrgastraum hinter dem Handshuhfach
- E El filtro se encuentra en el habitáculo detrás de la guantera

CK 10062

237 x 244 x 35/51



telajo pvc / pvc frame

O/E numbers

Honda 80292SDCA01 / 80292SHJA41

Cross References

Fram CF10062 Mann CU2358
Micronair MP180 Purflux AH221
Tecnocar E422 Fiaam PC8166

--- Ballade ---

01/14 ->

*

*



- I Il filtro è posizionato nell'abitacolo sul lato conducente
- GB The filter is located in the passenger compartment on the driver's side
- F Le filtre est situé dans l'habitacle du côté conducteur
- D Der Filter befindet sich im Fahrgastraum auf der Fahrerseite
- E El Filtro se encuentra en el habitáculo, del lado del conductor

CK 21003

210 x 205 x 30



O/E numbers

Honda 80291TF0E01 / 80291TF3E01 / 80292TF0G01

Cross References



Fram CF11182 Mann CU21003
Micronair MP385 Purflux AH339
Tecnocar E632 Fiaam PC8296





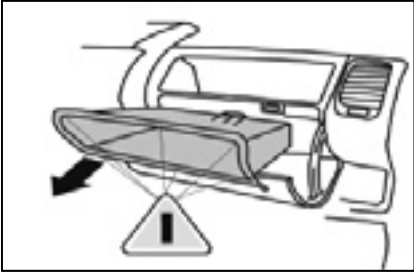

Anti-pollen



Activated carbon

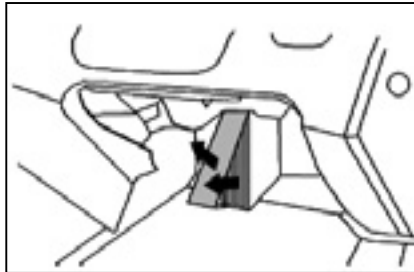

HONDA

<p>--- CITY ---</p> 	<p>08/00 -> 09/03</p> <p>* *</p>	<p>CK 10073-10 183,5 x 179 x 29</p>  <p><u>O/E numbers</u> Honda 08R79SAA600B / 80291SAAE01</p> <p><u>Cross References</u> Fram CF10073 Mann CU1835 Micronair MP158 Purflux AH303 Tecnocar E466 Fiaam PC8192</p>	<p>---</p>
--	-------------------------------------	--	------------

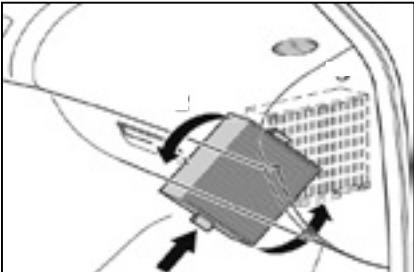
<p>--- City ---</p> 	<p>01/14 -></p> <p>* *</p>	<p>CK 21003 210 x 205 x 30</p>  <p><u>O/E numbers</u> Honda 80291TF0E01 / 80291TF3E01 / 80292TF0G01</p> <p><u>Cross References</u> Fram CF11182 Mann CU21003 Micronair MP385 Purflux AH339 Tecnocar E632 Fiaam PC8296</p>	<p>---</p>
--	-------------------------------	---	------------

<p>--- Civic VI ---</p> 	<p>09/94 -> 02/01</p> <p>* </p>	<p>CK 9338 224 x 198,5 x 30</p>  <p><u>O/E numbers</u> Honda 80290ST3E01 / 80291ST3E01</p> <p><u>Cross References</u> Fram CF9338 Mann CU2351/CU2520 Micronair MP080/MP232 Purflux AH165 Tecnocar E362 Fiaam PC8080</p>	<p>---</p>
--	------------------------------------	---	------------

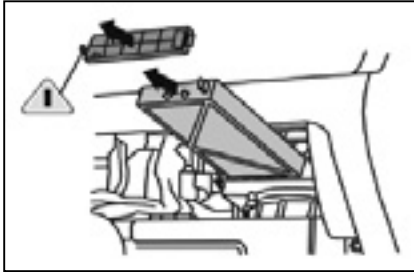
<p>--- Civic VI ---</p> 	<p>11/95 -> 02/01</p> <p> </p> <p>* </p>	<p>CK 5865 212 x 210 x 30</p>  <p><u>O/E numbers</u> Honda 08R79ST3600 / 79831ST3EC1</p> <p><u>Cross References</u> Fram CF5865 Mann CU2253 Micronair MP029 Purflux AH127 Tecnocar E328 Fiaam PC8017</p>	<p>---</p>
--	---	--	------------

<p>--- Civic VII ---</p> 	<p>02/01 -></p> <p>* </p>	<p>CK 421-2 225 x 112 x 29</p>  <p><u>O/E numbers</u> Honda 80292S6DG01 / 80292SCAE11</p> <p><u>Cross References</u> Fram CF9819-2 Mann CU2327-2 Micronair MP066-2 Purflux AH220 Tecnocar E421 Fiaam PC8143-2</p>	<p>CK 421-C-2 225 x 112 x 29</p>  <p><u>O/E numbers</u> Honda 80292S7A003</p> <p><u>Cross References</u> Fram..... Mann CUK2327-2 Micronair MC566-2 Purflux..... Tecnocar..... Fiaam.....</p>
---	------------------------------	---	--



Anti-pollen

Activated carbon

HONDA

--- Civic VIII ---

01/06 ->

*

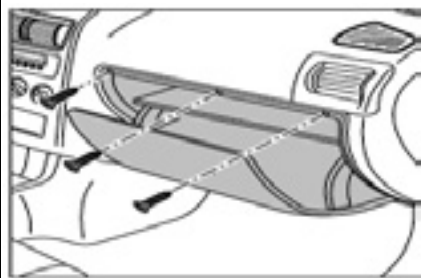

- I Il filtro è posizionato nell'abitacolo dietro il vano portaoggetti
- GB The filter is located in the passenger compartment behind the glove compartment
- F Le filtre est situé dans l'habitacle derrière la boîte à gants
- D Der filter befindet sich im Fahrgastraum hinter dem Handshuhfach
- E El filtro se encuentra en el habitáculo detrás de la guantera

CK 10411-10

240 x 197 x 30



O/E numbers

Honda 80292SMGE01

Cross References

Fram CF10411 Mann CU2454
Micronair MP202 Purfkux AH266
Tecocar E473 Fiaam PC8202

CK 10411-10-C

240 x 197 x 30



O/E numbers

Honda.....

Cross References

Fram..... Mann.....
Micronair MC702 Purfkux.....
Tecocar..... Fiaam.....

--- Civic VIII (1.3i Dsi Hybrid) ---

05/06 ->

*

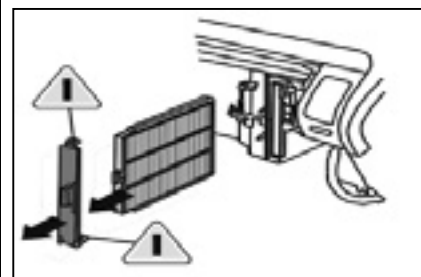

- I Il filtro è posizionato nell'abitacolo dietro il vano portaoggetti
- GB The filter is located in the passenger compartment behind the glove compartment
- F Le filtre est situé dans l'habitacle derrière la boîte à gants
- D Der filter befindet sich im Fahrgastraum hinter dem Handshuhfach
- E El filtro se encuentra en el habitáculo detrás de la guantera

CK 10062

237 x 244 x 35/51



telaio pvc / pvc frame

O/E numbers

Honda 80292SDCA01 / 80292SHJA41

Cross References

Fram CF10062 Mann CU2358
Micronair MP180 Purflux AH221
Tecocar E422 Fiaam PC8166

--- Civic IX ---

02/12 ->

*

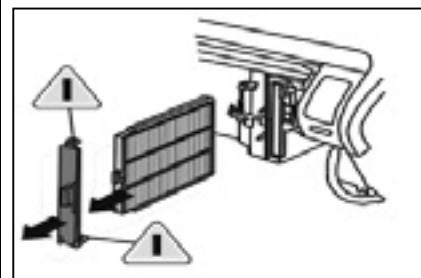

- I Il filtro è posizionato nell'abitacolo dietro il vano portaoggetti
- GB The filter is located in the passenger compartment behind the glove compartment
- F Le filtre est situé dans l'habitacle derrière la boîte à gants
- D Der filter befindet sich im Fahrgastraum hinter dem Handshuhfach
- E El filtro se encuentra en el habitáculo detrás de la guantera

CK 10062

237 x 244 x 35/51



telaio pvc / pvc frame

O/E numbers

Honda 80292SDCA01 / 80292SHJA41

Cross References

Fram CF10062 Mann CU2358
Micronair MP180 Purflux AH221
Tecocar E422 Fiaam PC8166

--- CR-V I ---

10/95 ->08/02

*

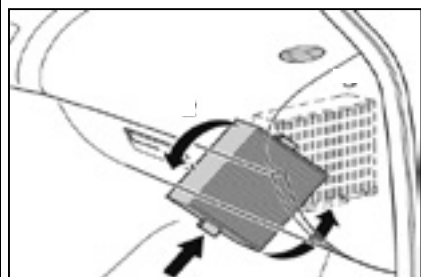

- I Il filtro è posizionato nell'abitacolo dietro il vano portaoggetti
- GB The filter is located in the passenger compartment behind the glove compartment
- F Le filtre est situé dans l'habitacle derrière la boîte à gants
- D Der filter befindet sich im Fahrgastraum hinter dem Handshuhfach
- E El filtro se encuentra en el habitáculo detrás de la guantera

CK 5865

212 x 210 x 30



O/E numbers

Honda 08R79ST3600 / 79831ST3EC1

Cross References

Fram CF5865 Mann CU2253
Micronair MP029 Purflux AH127
Tecocar E328 Fiaam PC8017

--- CR-V I ---

10/95 -> 08/02

*

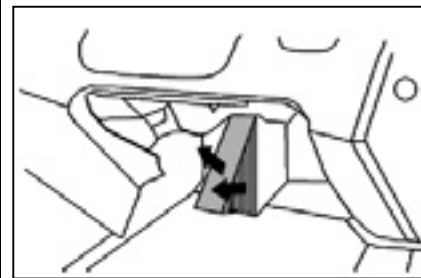

- I Il filtro è posizionato nell'abitacolo sotto il vano portaoggetti
- GB The filter is located in the passenger compartment under the glove compartment
- F Le filtre est situé dans l'habitacle en dessous de la boîte à gants
- D Der filter befindet sich im Fahrgastraum unter dem Handshuhfach
- E El filtro se encuentra en el habitáculo, bajo la guantera in de pasajeriiumte

CK 9338

224 x 198,5 x 30



O/E numbers

Honda 80290ST3E01 / 80291ST3E01

Cross References

Fram CF9338 Mann CU2351/CU2520
Micronair MP080/MP232 Purflux AH165
Tecocar E362 Fiaam PC8080



Anti-pollen

Activated carbon

HONDA

--- CR-V II ---

06/02 ->12/06

*

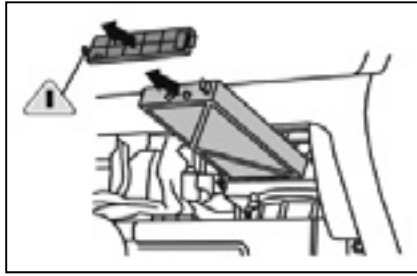

- I** Il filtro è posizionato nell'abitacolo dietro il vano portaoggetti
- GB** The filter is located in the passenger compartment behind the glove compartment
- F** Le filtre est situé dans l'habitacle derrière la boîte à gants
- D** Der filter befindet sich im Fahrgastraum hinter dem Handsuhfach
- E** El filtro se encuentra en el habitáculo detrás de la guantera

CK 421-2

225 x 112 x 29

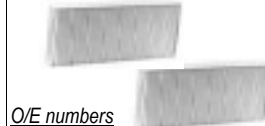

O/E numbers

Honda 80292S6DG01 / 80292SCAE11

Cross References

Fram CF9819-2 Mann CU2327-2
 Micronair MP066-2 Purflux AH220
 Tecnicar E421 Fiaam PC8143-2

CK 421-C-2

225 x 112 x 29



O/E numbers

Honda 80292S7A003

Cross References

Fram..... Mann CUK2327-2
 Micronair MC566-2 Purflux.....
 Tecnicar..... Fiaam.....

--- CR-V III ---

01/07 ->

*

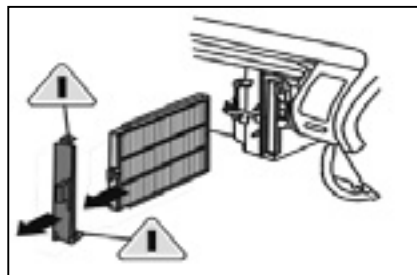

- I** Il filtro è posizionato nell'abitacolo dietro il vano portaoggetti
- GB** The filter is located in the passenger compartment behind the glove compartment
- F** Le filtre est situé dans l'habitacle derrière la boîte à gants
- D** Der filter befindet sich im Fahrgastraum hinter dem Handsuhfach
- E** El filtro se encuentra en el habitáculo detrás de la guantera

CK 10062

237 x 244 x 35/51



telajo pvc / pvc frame

O/E numbers

Honda 80292SDCA01 / 80292SHJA41

Cross References

Fram CF10062 Mann CU2358
 Micronair MP180 Purflux AH221
 Tecnicar E422 Fiaam PC8166

--- CR-V IV ---

10/12 ->

*

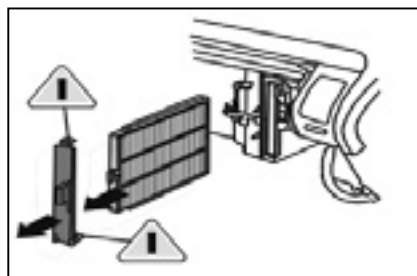

- I** Il filtro è posizionato nell'abitacolo dietro il vano portaoggetti
- GB** The filter is located in the passenger compartment behind the glove compartment
- F** Le filtre est situé dans l'habitacle derrière la boîte à gants
- D** Der filter befindet sich im Fahrgastraum hinter dem Handsuhfach
- E** El filtro se encuentra en el habitáculo detrás de la guantera

CK 10062

237 x 244 x 35/51



telajo pvc / pvc frame

O/E numbers

Honda 80292SDCA01 / 80292SHJA41

Cross References

Fram CF10062 Mann CU2358
 Micronair MP180 Purflux AH221
 Tecnicar E422 Fiaam PC8166

--- CR-Z ---

05/10 ->

*

*

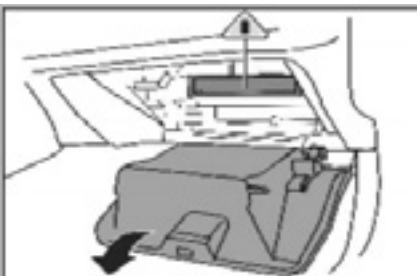

- I** Il filtro è posizionato nell'abitacolo sul lato conducente
- GB** The filter is located in the passenger compartment on the driver's side
- F** Le filtre est situé dans l'habitacle du côté conducteur
- D** Der Filter befindet sich im Fahrgastraum auf der Fahrerseite
- E** El Filtro se encuentra en el habitáculo, del lado del conductor

CK 21003

210 x 205 x 30



O/E numbers

Honda 80291TF0E01 / 80291TF3E01 / 80292TF0G01

Cross References

Fram CF11182 Mann CU21003
 Micronair MP385 Purflux AH339
 Tecnicar E632 Fiaam PC8296

--- FR-V ---

01/05 ->

*

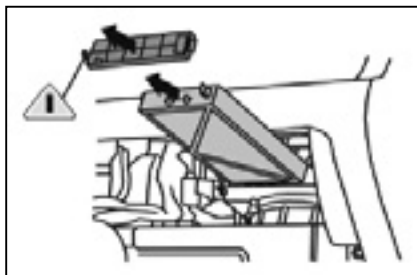

- I** Il filtro è posizionato nell'abitacolo dietro il vano portaoggetti
- GB** The filter is located in the passenger compartment behind the glove compartment
- F** Le filtre est situé dans l'habitacle derrière la boîte à gants
- D** Der filter befindet sich im Fahrgastraum hinter dem Handsuhfach
- E** El filtro se encuentra en el habitáculo detrás de la guantera

CK 421-2

225 x 112 x 29

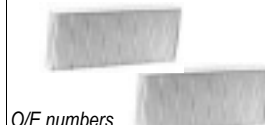

O/E numbers

Honda 80292S6DG01 / 80292SCAE11

Cross References

Fram CF9819-2 Mann CU2327-2
 Micronair MP066-2 Purflux AH220
 Tecnicar E421 Fiaam PC8143-2

CK 421-C-2

225 x 112 x 29



O/E numbers

Honda 80292S7A003

Cross References

Fram..... Mann CUK2327-2
 Micronair MC566-2 Purflux.....
 Tecnicar..... Fiaam.....



Anno di fabbricazione / Year of construction
 Anné de fabrication / Baujahr / Año de fabricación



Con climatizzatore / With air-conditioning / Avec climatisation
 Mit Klimaanlage / Con instalación de aire acondicionado



Senza climatizzatore / Without air-conditioning / Sans climatisation
 Ohne Klimaanlage / Sin instalación de aire acondicionado



Anti-pollen

Activated carbon

HONDA

--- Jazz III (GE) ---

04/09 ->

*

*

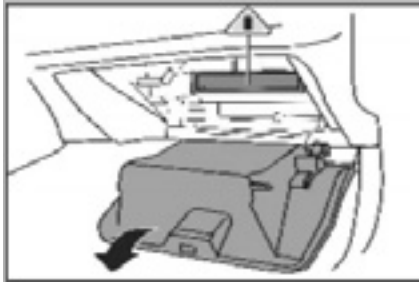

- I** Il filtro è posizionato nell'abitacolo sul lato conducente
- GB** The filter is located in the passenger compartment on the driver's side
- F** Le filtre est situé dans l'habitacle du côté conducteur
- D** Der Filter befindet sich im Fahrgastraum auf der Fahrerseite
- E** El Filtro se encuentra en el habitáculo, del lado del conductor

CK 21003

210 x 205 x 30



O/E numbers

Honda 80291TF0E01 / 80291TF3E01 / 80292TF0G01

Cross References

Fram CF11182 Mann CU21003
Micronair MP385 Purflux AH339
Tecnicar E632 Fiaam PC8296

--- Jazz IV / Fit IV ---

06/15 ->

*

*



- I** Il filtro è posizionato nell'abitacolo sul lato conducente
- GB** The filter is located in the passenger compartment on the driver's side
- F** Le filtre est situé dans l'habitacle du côté conducteur
- D** Der Filter befindet sich im Fahrgastraum auf der Fahrerseite
- E** El Filtro se encuentra en el habitáculo, del lado del conductor

CK 21003

210 x 205 x 30



O/E numbers

Honda 80291TF0E01 / 80291TF3E01 / 80292TF0G01

Cross References

Fram CF11182 Mann CU21003
Micronair MP385 Purflux AH339
Tecnicar E632 Fiaam PC8296

--- Legend ---

09/06 ->

*

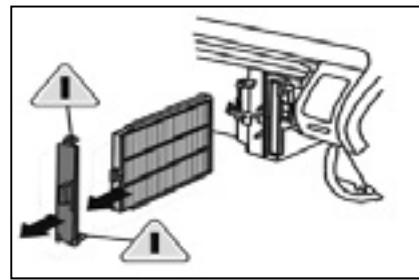

- I** Il filtro è posizionato nell'abitacolo dietro il vano portaoggetti
- GB** The filter is located in the passenger compartment behind the glove compartment
- F** Le filtre est situé dans l'habitacle derrière la boîte à gants
- D** Der filter befindet sich im Fahrgastraum hinter dem Handschuhfach
- E** El filtro se encuentra en el habitáculo detrás de la guantera

CK 10062

237 x 244 x 35/51

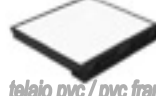

telaio pvc / pvc frame

O/E numbers

Honda 80292SDCA01 / 80292SHJA41

Cross References

Fram CF10062 Mann CU2358
Micronair MP180 Purflux AH221
Tecnicar E422 Fiaam PC8166

--- Pilot ---

05/08 ->

*

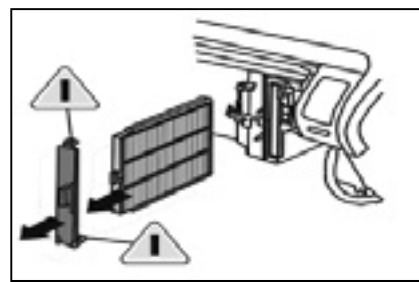

- I** Il filtro è posizionato nell'abitacolo dietro il vano portaoggetti
- GB** The filter is located in the passenger compartment behind the glove compartment
- F** Le filtre est situé dans l'habitacle derrière la boîte à gants
- D** Der filter befindet sich im Fahrgastraum hinter dem Handschuhfach
- E** El filtro se encuentra en el habitáculo detrás de la guantera

CK 10062

237 x 244 x 35/51



telaio pvc / pvc frame

O/E numbers

Honda 80292SDCA01 / 80292SHJA41

Cross References

Fram CF10062 Mann CU2358
Micronair MP180 Purflux AH221
Tecnicar E422 Fiaam PC8166

--- Stream ---

01/01 ->

*

*

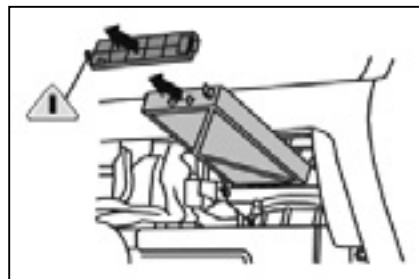

- I** Il filtro è posizionato nell'abitacolo dietro il vano portaoggetti
- GB** The filter is located in the passenger compartment behind the glove compartment
- F** Le filtre est situé dans l'habitacle derrière la boîte à gants
- D** Der filter befindet sich im Fahrgastraum hinter dem Handschuhfach
- E** El filtro se encuentra en el habitáculo detrás de la guantera

CK 421-2

225 x 112 x 29



O/E numbers

Honda 80292S6DG01 / 80292SCAE11

Cross References

Fram CF9819-2 Mann CU2327
Micronair MP066-2 Purflux AH220
Tecnicar E421 Fiaam PC8143-2

CK 421-C-2

225 x 112 x 29



O/E numbers

Honda 80292S7A003

Cross References









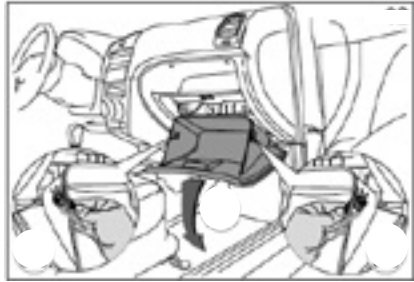

Fram..... Mann CUK2327-2
Micronair MC566-2 Purflux.....
Tecnicar..... Fiaam.....

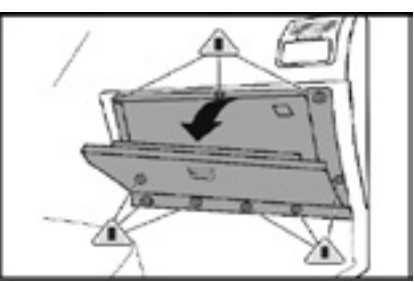
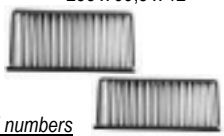

Anti-pollen

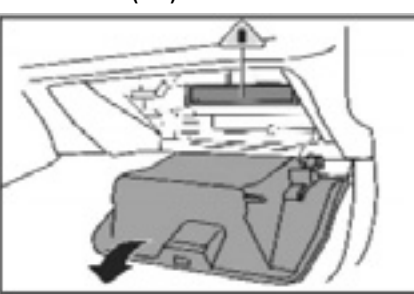
Activated carbon

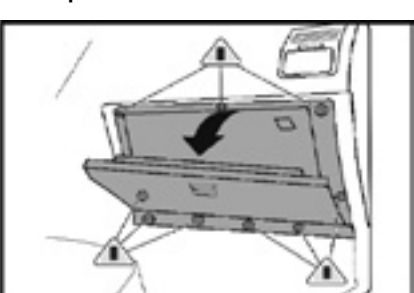
HYUNDAI

<p>--- Eon ---</p> 	<p>11/13 -> * </p> <p> I Il filtro è posizionato nell'abitacolo dietro il vano portaoggetti GB The filter is located in the passenger compartment behind the glove compartment F Le filtre est situé dans l'habitacle derrière la boîte à gants D Der filter befindet sich im Fahrgastraum hinter dem Handsuhfach E El filtro se encuentra en el habitáculo detrás de la guantera </p>	<p>CK 1910 186/181 x 187/177 x 12/14</p>  <p><u>O/E numbers</u> Hyundai 9713307000 / 9713307010</p> <p><u>Cross References</u> Fram CF10627 Mann CU1910 Micronair MP220 Purflux AH301 Tecocar E496 Fiaam PC8248</p>	<p>CK 1910-C 186/181 x 187/177 x 12/14</p>  <p><u>O/E numbers</u> Hyundai.....</p> <p><u>Cross References</u> Fram..... Mann Micronair..... Purflux..... Tecocar..... Fiaam.....</p>
<p>--- Accent II ---</p> 	<p>12/01 -> 06/06 </p> <p> I Il filtro è posizionato nell'abitacolo dietro il vano portaoggetti GB The filter is located in the passenger compartment behind the glove compartment F Le filtre est situé dans l'habitacle derrière la boîte à gants D Der filter befindet sich im Fahrgastraum hinter dem Handsuhfach E El filtro se encuentra en el habitáculo detrás de la guantera </p>	<p>CK 2506-2 255 x 99,5 x 12</p>  <p><u>O/E numbers</u> Hyundai 976171C000 - 976171C200</p> <p><u>Cross References</u> Fram CF10245 Mann CU2506-2 Micronair MP203-2 Purflux AH375-2 Tecocar E669-2 Fiaam PC8345-2</p>	<p>---</p>
<p>--- Accent III (MC) ---</p> 	<p>06/06 -> * </p> <p> I Il filtro è posizionato nell'abitacolo sul lato conducente GB The filter is located in the passenger compartment on the driver's side F Le filtre est situé dans l'habitacle du côté conducteur D Der Filter befindet sich im Fahrgastraum auf der Fahrerseite E El Filtro se encuentra en el habitáculo, del lado del conductor </p>	<p>CK 2331 243 x 202 x 20</p>  <p><u>O/E numbers</u> Hyundai 971331E000 / 971332H001</p> <p><u>Cross References</u> Fram CF11434 Mann CU2331/CU24013 Micronair MP382 Purflux AH360 Tecocar Fiaam PC8330</p>	<p>CK 2331-C 243 x 202 x 20</p>  <p><u>O/E numbers</u> Hyundai</p> <p><u>Cross References</u> Fram..... Mann Micronair..... Purflux..... Tecocar..... Fiaam.....</p>
<p>--- Accent IV (RB) ---</p> 	<p>01/11 -> * </p> <p> I Il filtro è posizionato nell'abitacolo sul lato conducente GB The filter is located in the passenger compartment on the driver's side F Le filtre est situé dans l'habitacle du côté conducteur D Der Filter befindet sich im Fahrgastraum auf der Fahrerseite E El Filtro se encuentra en el habitáculo, del lado del conductor </p>	<p>CK 2336 225 x 202 x 17</p>  <p><u>O/E numbers</u> Hyundai 9999Z07022 / 087902E200</p> <p><u>Cross References</u> Fram CF10210 Mann CU2336 Micronair MP196 Purflux AH248 Tecocar E451/E460 Fiaam PC8187</p>	<p>---</p>
<p>--- Coupé II ---</p> 	<p>02/02 -> 08/09 </p> <p> I Il filtro è posizionato nell'abitacolo dietro il vano portaoggetti GB The filter is located in the passenger compartment behind the glove compartment F Le filtre est situé dans l'habitacle derrière la boîte à gants D Der filter befindet sich im Fahrgastraum hinter dem Handsuhfach E El filtro se encuentra en el habitáculo detrás de la guantera </p>	<p>CK 2356 269/263 x 238/227 x 30/34</p>  <p><u>O/E numbers</u> Hyundai 97133-2D000 / 9999Z-07015</p> <p><u>Cross References</u> Fram CF10329 Mann CU2356 Micronair MP213 Purflux AH257 Tecocar E462 Fiaam PC8191</p>	<p>---</p>



Anti-pollen

Activated carbon

HYUNDAI

--- Elantra ---

06/00 -> 04/03

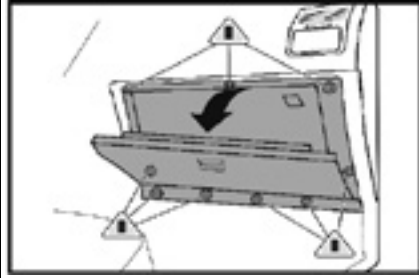

- I** Il filtro è posizionato nell'abitacolo dietro il vano portaoggetti
- GB** The filter is located in the passenger compartment behind the glove compartment
- F** Le filtre est situé dans l'habitacle derrière la boîte à gants
- D** Der filter befindet sich im Fahrgastraum hinter dem Handschuhfach
- E** El filtro se encuentra en el habitáculo detrás de la guantera

CK 2356

269/263 x 238/227 x 30/34



O/E numbers

Hyundai 97133-2D000 / 9999Z-07015

Cross References

Fram CF10329 Mann CU2356
Micronair MP213 Purflux AH257
Tecocar E462 Fiaam PC8191

--- Elantra II (XD2) ---

05/06 ->

*



- I** Il filtro è posizionato nell'abitacolo sul lato conducente
- GB** The filter is located in the passenger compartment on the driver's side
- F** Le filtre est situé dans l'habitacle du côté conducteur
- D** Der Filter befindet sich im Fahrgastraum auf der Fahrerseite
- E** El Filtro se encuentra en el habitáculo, del lado del conductor

CK 24013

238 x 198 x 20



O/E numbers

Hyundai 971332H001 / 971332H001AT

Cross References

Fram Mann CU24013
Micronair MP382 Purflux
Tecocar Fiaam

--- Elantra III (MD) ---

06/11 ->

*



- I** Il filtro è posizionato nell'abitacolo sul lato conducente
- GB** The filter is located in the passenger compartment on the driver's side
- F** Le filtre est situé dans l'habitacle du côté conducteur
- D** Der Filter befindet sich im Fahrgastraum auf der Fahrerseite
- E** El Filtro se encuentra en el habitáculo, del lado del conductor

CK 24013

238 x 198 x 20



O/E numbers

Hyundai 971332H001 / 971332H001AT

Cross References

Fram Mann CU24013
Micronair MP382 Purflux
Tecocar Fiaam

--- Genesis ---

01/08 ->

*

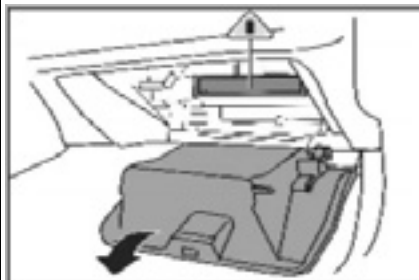

- I** Il filtro è posizionato nell'abitacolo sul lato conducente
- GB** The filter is located in the passenger compartment on the driver's side
- F** Le filtre est situé dans l'habitacle du côté conducteur
- D** Der Filter befindet sich im Fahrgastraum auf der Fahrerseite
- E** El Filtro se encuentra en el habitáculo, del lado del conductor

CK 2336

225 x 202 x 17



O/E numbers

Hyundai 9999Z07022 / 087902E200

Cross References

Fram CF10210 Mann CU2336
Micronair MP196 Purflux AH248
Tecocar E451/E460 Fiaam PC8187

--- Getz ---

09/02 ->

*

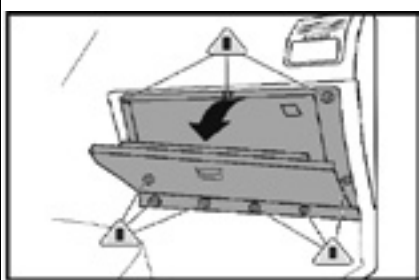

- I** Il filtro è posizionato nell'abitacolo dietro il vano portaoggetti
- GB** The filter is located in the passenger compartment behind the glove compartment
- F** Le filtre est situé dans l'habitacle derrière la boîte à gants
- D** Der filter befindet sich im Fahrgastraum hinter dem Handschuhfach
- E** El filtro se encuentra en el habitáculo detrás de la guantera

CK 2506-2

255 x 99,5 x 12

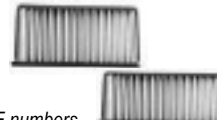

O/E numbers

Hyundai 976171C000 / 976171C200

Cross References

Fram CF10245 Mann CU2506-2
Micronair MP203-2 Purflux AH375-2
Tecocar E669-2 Fiaam PC8345-2



Anti-pollen

Activated carbon

HYUNDAI

--- Grandeour / Azera ---

02/11 ->

*

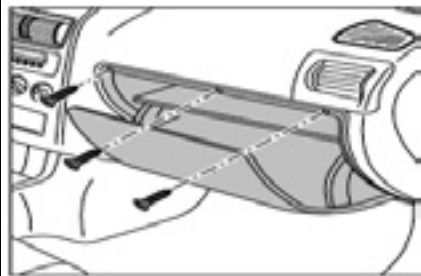

- I Il filtro è posizionato nell'abitacolo dietro il vano portaoggetti
- GB The filter is located in the passenger compartment behind the glove compartment
- F Le filtre est situé dans l'habitacle derrière la boîte à gants
- D Der filter befindet sich im Fahrgastraum hinter dem Handschuhfach
- E El filtro se encuentra en el habitáculo detrás de la guantera

CK 26017

253,5 x 225 x 20



O/E numbers

Hyundai 971333SAA0 / 971333SAA0AT

Cross References

Fram CF11178 Mann CU26017
Micronair Purfkux AH406
Tecocar E697 Fiaam PC8376

CK 26017-C

253,5 x 225 x 20



O/E numbers

Hyundai

Cross References

Fram..... Mann CUK26017
Micronair Purfkux.....
Tecocar..... Fiaam.....

--- i10 ---

03/08 ->

*

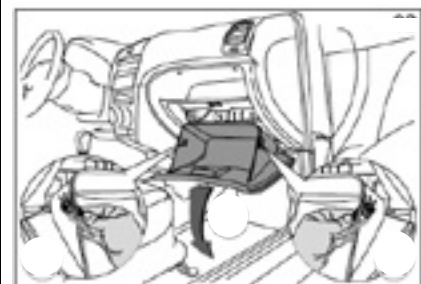

- I Il filtro è posizionato nell'abitacolo dietro il vano portaoggetti
- GB The filter is located in the passenger compartment behind the glove compartment
- F Le filtre est situé dans l'habitacle derrière la boîte à gants
- D Der filter befindet sich im Fahrgastraum hinter dem Handschuhfach
- E El filtro se encuentra en el habitáculo detrás de la guantera

CK 1910

186/181 x 187/177 x 12/14



O/E numbers

Hyundai 9713307000 / 9713307010

Cross References

Fram CF10627 Mann CU1910
Micronair MP220 Purflux AH301
Tecocar E496 Fiaam PC8248

CK 1910-C

186/181 x 187/177 x 12/14



O/E numbers

Hyundai.....

Cross References

Fram..... Mann
Micronair..... Purflux.....
Tecocar..... Fiaam.....

--- i10 II ---

11/13 ->

*

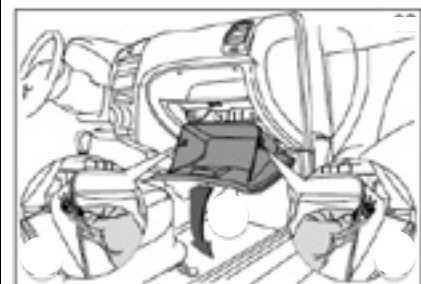

- I Il filtro è posizionato nell'abitacolo dietro il vano portaoggetti
- GB The filter is located in the passenger compartment behind the glove compartment
- F Le filtre est situé dans l'habitacle derrière la boîte à gants
- D Der filter befindet sich im Fahrgastraum hinter dem Handschuhfach
- E El filtro se encuentra en el habitáculo detrás de la guantera

CK 1910

186/181 x 187/177 x 12/14



O/E numbers

Hyundai 9713307000 / 9713307010

Cross References

Fram CF10627 Mann CU1910
Micronair MP220 Purflux AH301
Tecocar E496 Fiaam PC8248

CK 1910-C

186/181 x 187/177 x 12/14



O/E numbers

Hyundai.....

Cross References

Fram..... Mann
Micronair..... Purflux.....
Tecocar..... Fiaam.....

--- i20 --- Country of vehicle manufacture Turkey

02/09 ->

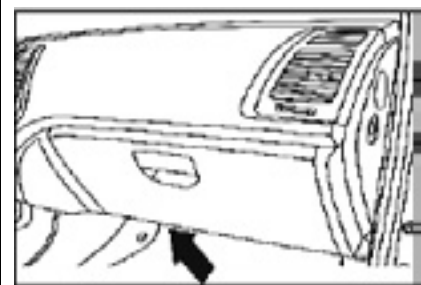

- I Il filtro è posizionato nell'abitacolo dietro il vano portaoggetti
- GB The filter is located in the passenger compartment behind the glove compartment
- F Le filtre est situé dans l'habitacle derrière la boîte à gants
- D Der filter befindet sich im Fahrgastraum hinter dem Handschuhfach
- E El filtro se encuentra en el habitáculo detrás de la guantera

CK 25008-2

250 x 84 x 20



O/E numbers

Hyundai 971334P000

Cross References

Fram CF11644-2 Mann CU25008-2
Micronair Pufux AH393-2
Tecocar E684-2 Fiaam PC8362-2

CK 25008-C-2

250 x 84 x 20



O/E numbers

Hyundai

Cross References

Fram..... Mann.....
Micronair..... Pufux.....
Tecocar..... Fiaam.....

--- i20 --- Country of vehicle manufacture India

02/09 ->

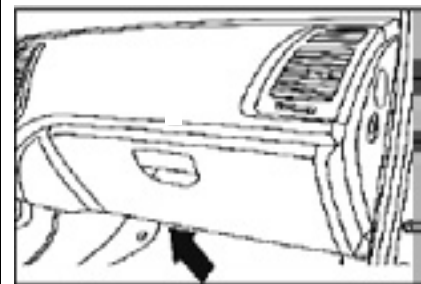

- I Il filtro è posizionato nell'abitacolo dietro il vano portaoggetti
- GB The filter is located in the passenger compartment behind the glove compartment
- F Le filtre est situé dans l'habitacle derrière la boîte à gants
- D Der filter befindet sich im Fahrgastraum hinter dem Handschuhfach
- E El filtro se encuentra en el habitáculo detrás de la guantera

CK 29002-2

287 x 81 x 19



O/E numbers

Hyundai 971331J000 / 971331J000AT

Cross References

Fram CF10933-2 Mann CU29002-2
Micronair MP396-2 Pufux AH310-2
Tecocar E612-2 Fiaam PC8269-2

CK 29002-C-2

287 x 81 x 19

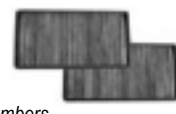

O/E numbers

Hyundai

Cross References



Fram..... Mann.....
Micronair..... Pufux.....
Tecocar..... Fiaam.....





Anti-pollen



Activated carbon

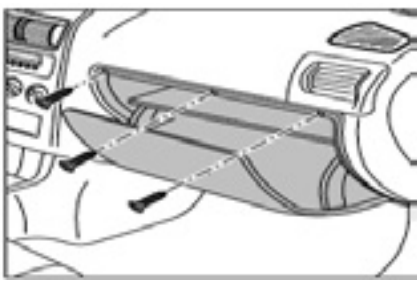

HYUNDAI

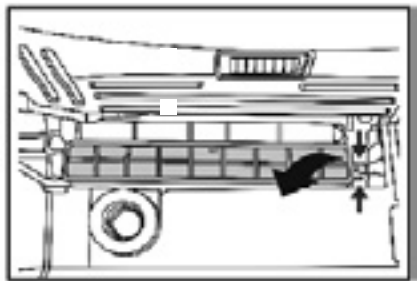
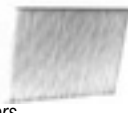
<p>--- i20 II ---</p>  <p>I Il filtro è posizionato nell'abitacolo sul lato conducente</p> <p>GB The filter is located in the passenger compartment on the driver's side</p> <p>F Le filtre est situé dans l'habitacle du côté conducteur</p> <p>D Der Filter befindet sich im Fahrgastraum auf der Fahrerseite</p> <p>E El Filtro se encuentra en el habitáculo, del lado del conductor</p>	<p>11/14 -> * <input type="checkbox"/></p>	<p>CK 24013 238 x 198 x 20</p>  <p><u>O/E numbers</u> Hyundai 971332H001 / 971332H001AT</p> <p><u>Cross References</u> Fram Mann CU24013 Micronair MP382 Purflux Tecnicar Fiaam</p>	<p>---</p>
---	---	--	------------

<p>--- ix20 ---</p>  <p>I Il filtro è posizionato nell'abitacolo dietro il vano portaoggetti</p> <p>GB The filter is located in the passenger compartment behind the glove compartment</p> <p>F Le filtre est situé dans l'habitacle derrière la boîte à gants</p> <p>D Der filter befindet sich im Fahrgastraum hinter dem Handshuhfach</p> <p>E El filtro se encuentra en el habitáculo detrás de la guantera</p>	<p>10/10 -> * <input type="checkbox"/></p>	<p>CK 23010 230 x 180 x 20</p>  <p><u>O/E numbers</u> Hyundai 971331P000</p> <p><u>Cross References</u> Fram CF10939 Mann CU23010 Micronair MP320 Purflux AH332 Tecnicar E626 Fiaam PC8291</p>	<p>CK 23010-C 230 x 180 x 20</p>  <p><u>O/E numbers</u> Hyundai</p> <p><u>Cross References</u> Fram..... Mann..... Micronair Purflux..... Tecnicar..... Fiaam.....</p>
--	---	---	--

<p>--- i30 + i30 cw (FD) ---</p>  <p>I Il filtro è posizionato nell'abitacolo dietro il vano portaoggetti</p> <p>GB The filter is located in the passenger compartment behind the glove compartment</p> <p>F Le filtre est situé dans l'habitacle derrière la boîte à gants</p> <p>D Der filter befindet sich im Fahrgastraum hinter dem Handshuhfach</p> <p>E El filtro se encuentra en el habitáculo detrás de la guantera</p>	<p>08/07 -> 06/12 <input type="checkbox"/> <input type="checkbox"/></p>	<p>CK 2532-10 245 x 172 x 20</p>  <p><u>O/E numbers</u> Hyundai 971331H000 / 971332L000</p> <p><u>Cross References</u> Fram CF10471 Mann CU2532/CU2631 Micronair MP269 Purflux AH270 Tecnicar E479 Fiaam PC8211</p>	<p>---</p>
---	--	--	------------

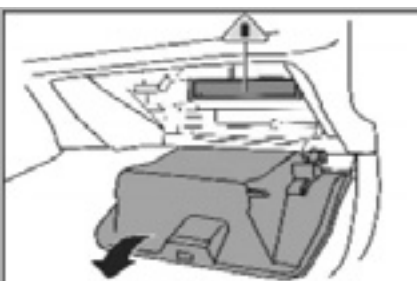
<p>--- i30 + i30 cw (GD) ---</p>  <p>I Il filtro è posizionato nell'abitacolo sul lato conducente</p> <p>GB The filter is located in the passenger compartment on the driver's side</p> <p>F Le filtre est situé dans l'habitacle du côté conducteur</p> <p>D Der Filter befindet sich im Fahrgastraum auf der Fahrerseite</p> <p>E El Filtro se encuentra en el habitáculo, del lado del conductor</p>	<p>03/12 -> * <input type="checkbox"/></p>	<p>CK 24013 238 x 198 x 20</p>  <p><u>O/E numbers</u> Hyundai 971332H001 / 971332H001AT</p> <p><u>Cross References</u> Fram Mann CU24013 Micronair MP382 Purflux Tecnicar Fiaam</p>	<p>---</p>
--	---	--	------------



<p>--- ix35 / Tucson ---</p>  <p>I Il filtro è posizionato nell'abitacolo sul lato conducente</p> <p>GB The filter is located in the passenger compartment on the driver's side</p> <p>F Le filtre est situé dans l'habitacle du côté conducteur</p> <p>D Der Filter befindet sich im Fahrgastraum auf der Fahrerseite</p> <p>E El Filtro se encuentra en el habitáculo, del lado del conductor</p>	<p>03/10 -> * <input type="checkbox"/></p>	<p>CK 24004 238 x 194 x 20</p>  <p><u>O/E numbers</u> Hyundai 971332E250 / 971332E260</p> <p><u>Cross References</u> Fram CF10889 Mann CU24004 Micronair MP164 Purflux AH359 Tecnicar E652 Fiaam PC8329</p>	<p>CK 24004-C 238 x 194 x 20</p>  <p><u>O/E numbers</u> Hyundai 971332E250 / 9999Z07026</p> <p><u>Cross References</u> Fram..... Mann Micronair..... Purflux..... Tecnicar..... Fiaam.....</p>
--	---	--	--





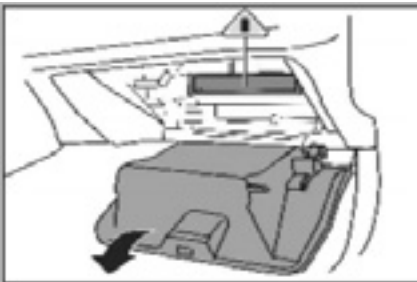

Anti-pollen

Activated carbon

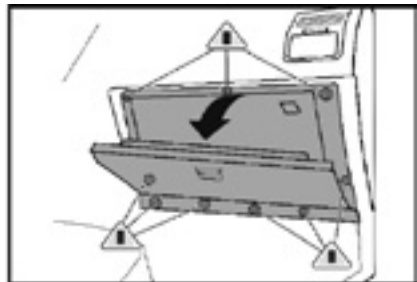

HYUNDAI

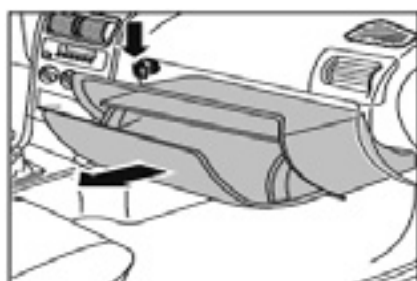
<p>--- i40 ---</p>  <p> I Il filtro è posizionato nell'abitacolo sul lato conducente GB The filter is located in the passenger compartment on the driver's side F Le filtre est situé dans l'habitacle du côté conducteur D Der Filter befindet sich im Fahrgastraum auf der Fahrerseite E El Filtro se encuentra en el habitáculo, del lado del conductor </p>	<p>07/11 -> * <input type="checkbox"/></p>	<p>CK 2336 225 x 202 x 17</p>  <p><u>O/E numbers</u> Hyundai 9999Z07022 / 087902E200</p> <p><u>Cross References</u> Fram CF10210 Mann CU2336 Micronair MP196 Purflux AH248 Iecnocar E451/E460 Fiaam PC8187</p>	<p>---</p>
--	---	---	------------

<p>--- Matrix ---</p>  <p> I Il filtro è posizionato nell'abitacolo dietro il vano portaoggetti GB The filter is located in the passenger compartment behind the glove compartment F Le filtre est situé dans l'habitacle derrière la boîte à gants D Der filter befindet sich im Fahrgastraum hinter dem Handschuhfach E El filtro se encuentra en el habitáculo detrás de la guantera </p>	<p>06/01 -> <input type="checkbox"/> <input type="checkbox"/></p>	<p>CK 2356 269/263 x 238/227 x 30/34</p>  <p><u>O/E numbers</u> Hyundai 97133-2D000 / 9999Z-07015</p> <p><u>Cross References</u> Fram CF10329 Mann CU2356 Micronair MP213 Purflux AH257 Tecocar E462 Fiaam PC8191</p>	<p>---</p>
---	--	--	------------

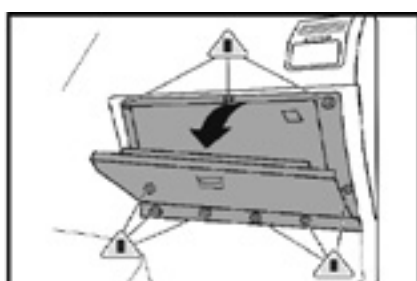
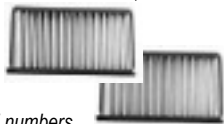
<p>--- Santa Fe I ---</p>  <p> I Il filtro è posizionato nell'abitacolo dietro il vano portaoggetti GB The filter is located in the passenger compartment behind the glove compartment F Le filtre est situé dans l'habitacle derrière la boîte à gants D Der filter befindet sich im Fahrgastraum hinter dem Handschuhfach E El filtro se encuentra en el habitáculo detrás de la guantera </p>	<p>02/01 -> 04/03 * <input type="checkbox"/></p>	<p>CK 9756 263/252 x 194/189 x 37,5</p>  <p><u>O/E numbers</u> Hyundai 97619-38100 / 9999-07010</p> <p><u>Cross References</u> Fram CF9756 Mann CU2647 Micronair MP204 Purflux AH230 Tecocar E429 Fiaam PC8141</p>	<p>---</p>
---	---	---	------------

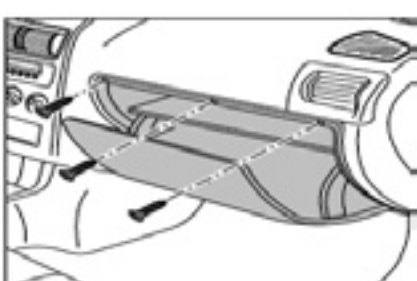
<p>--- Santa Fe I ---</p>  <p> I Il filtro è posizionato nell'abitacolo dietro il vano portaoggetti GB The filter is located in the passenger compartment behind the glove compartment F Le filtre est situé dans l'habitacle derrière la boîte à gants D Der filter befindet sich im Fahrgastraum hinter dem Handschuhfach E El filtro se encuentra en el habitáculo detrás de la guantera </p>	<p>05/03 -> 03/06 * <input type="checkbox"/></p>	<p>CK 2542-2 249 x 98,5 x 38</p>  <p><u>O/E numbers</u> Hyundai 976193D000 / 976193D100</p> <p><u>Cross References</u> Fram CF11506-2 Mann CU2542-2 Micronair MP322-2 Purflux AH383-2 Tecocar E674-2 Fiaam PC8351-2</p>	<p>---</p>
---	---	--	------------

<p>--- Santa Fe III ---</p>  <p> I Il filtro è posizionato nell'abitacolo dietro il vano portaoggetti GB The filter is located in the passenger compartment behind the glove compartment F Le filtre est situé dans l'habitacle derrière la boîte à gants D Der filter befindet sich im Fahrgastraum hinter dem Handschuhfach E El filtro se encuentra en el habitáculo detrás de la guantera </p>	<p>02/11 -> * <input type="checkbox"/></p>	<p>CK 26017 253,5 x 225 x 20</p>  <p><u>O/E numbers</u> Hyundai 971333SAA0 / 971333SAA0A1</p> <p><u>Cross References</u> Fram CF11178 Mann CU26017 Micronair Purflux AH406 Tecocar E697 Fiaam PC8376</p>	<p>CK 26017-C 253,5 x 225 x 20</p>  <p><u>O/E numbers</u> Hyundai</p> <p><u>Cross References</u> Fram..... Mann CUK26017 Micronair Purflux..... Tecocar..... Fiaam.....</p>
---	---	---	---



Anti-pollen

Activated carbon

HYUNDAI

--- Sonata III (EF) ---

03/98 -> 10/01

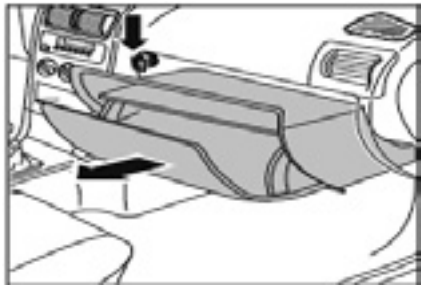

- I Il filtro è posizionato nell'abitacolo dietro il vano portaoggetti
- GB The filter is located in the passenger compartment behind the glove compartment
- F Le filtre est situé dans l'habitacle derrière la boîte à gants
- D Der filter befindet sich im Fahrgastraum hinter dem Handshuhfach
- E El filtro se encuentra en el habitáculo detrás de la guantera

CK 9756

263/252 x 194/189 x 37,5



O/E numbers

Hyundai 97619-38100 / 9999-07010

Cross References

Fram CF9756 Mann CU2647
Micronair MP204 Purflux AH230
Tecocar E429 Fiaam PC8141

--- Sonata IV (EU4 / EF-B) ---

09/01 -> 04/05

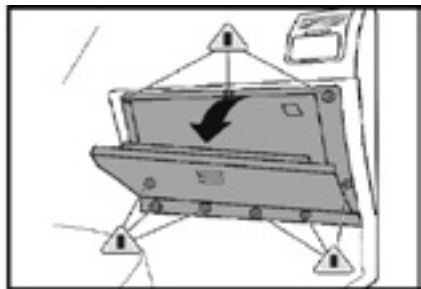

- I Il filtro è posizionato nell'abitacolo dietro il vano portaoggetti
- GB The filter is located in the passenger compartment behind the glove compartment
- F Le filtre est situé dans l'habitacle derrière la boîte à gants
- D Der filter befindet sich im Fahrgastraum hinter dem Handshuhfach
- E El filtro se encuentra en el habitáculo detrás de la guantera

CK 2542-2

249 x 98,5 x 38



O/E numbers

Hyundai 976193D000 / 976193D100

Cross References

Fram CF11506-2 Mann CU2542-2
Micronair MP322-2 Purflux AH383-2
Tecocar E674-2 Fiaam PC8351-2

--- Sonata VI (YF) ---

10/09 ->

*

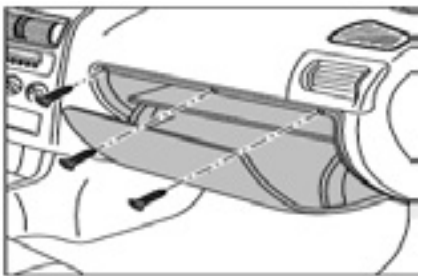

- I Il filtro è posizionato nell'abitacolo dietro il vano portaoggetti
- GB The filter is located in the passenger compartment behind the glove compartment
- F Le filtre est situé dans l'habitacle derrière la boîte à gants
- D Der filter befindet sich im Fahrgastraum hinter dem Handshuhfach
- E El filtro se encuentra en el habitáculo detrás de la guantera

CK 26017

253,5 x 225 x 20



O/E numbers

Hyundai 971333SAA0 / 971333SAA0AT

Cross References

Fram CF11178 Mann CU26017
Micronair Purflux AH406
Tecocar E697 Fiaam PC8376

CK 26017-C

253,5 x 225 x 20



O/E numbers

Hyundai

Cross References

Fram..... Mann CUK26017
Micronair Purflux.....
Tecocar..... Fiaam.....

--- Trajet ---

05/00 -> 07/08

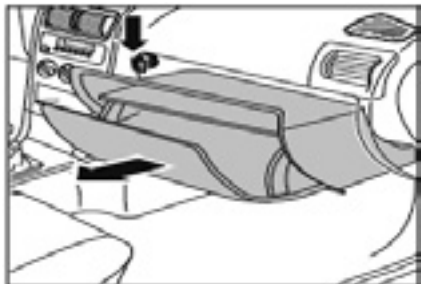

- I Il filtro è posizionato nell'abitacolo dietro il vano portaoggetti
- GB The filter is located in the passenger compartment behind the glove compartment
- F Le filtre est situé dans l'habitacle derrière la boîte à gants
- D Der filter befindet sich im Fahrgastraum hinter dem Handshuhfach
- E El filtro se encuentra en el habitáculo detrás de la guantera

CK 9756

263/252 x 194/189 x 37,5



O/E numbers

Hyundai 97619-38100 / 9999-07010

Cross References

Fram CF9756 Mann CU2647
Micronair MP204 Purflux AH230
Tecocar E429 Fiaam PC8141

--- Tucson ---

-> left-hand drive / partly/or

09/04 -> 03/10

*



- I Il filtro è posizionato nell'abitacolo sul lato conducente
- GB The filter is located in the passenger compartment on the driver's side
- F Le filtre est situé dans l'habitacle du côté conducteur
- D Der Filter befindet sich im Fahrgastraum auf der Fahrerseite
- E El Filtro se encuentra en el habitáculo, del lado del conductor

CK 2336

225 x 202 x 17



O/E numbers

Hyundai 9999Z07022 / 087902E200

Cross References

Fram CF10210 Mann CU2336
Micronair MP196 Purflux AH248
Tecocar E451/E460 Fiaam PC8187



Anno di fabbricazione / Year of construction
Anné de fabrication / Baujahr / Año de fabricación



Con climatizzatore / With air-conditioning / Avec climatisation
Mit Klimaanlage / Con instalación de aire acondicionado





Senza climatizzatore / Without air-conditioning / Sans climatisation
Ohne Klimaanlage / Sin instalación de aire acondicionado





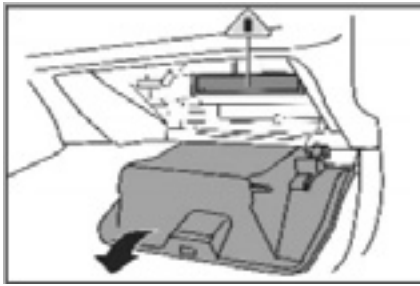

Anti-pollen



Activated carbon

HYUNDAI

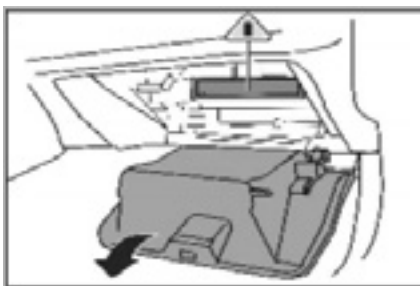
<p>--- Tucson --- -> left-hand drive</p>  <p>I Il filtro è posizionato nell'abitacolo sul lato conducente</p> <p>GB The filter is located in the passenger compartment on the driver's side</p> <p>F Le filtre est situé dans l'habitacle du côté conducteur</p> <p>D Der Filter befindet sich im Fahrgastraum auf der Fahrerseite</p> <p>E El Filtro se encuentra en el habitáculo, del lado del conductor</p>	<p>09/04 -> 03/10 * <input type="checkbox"/></p>	<p>CK 24004 238 x 194 x 20</p>  <p><u>O/E numbers</u> Hyundai 971332E250 / 971332E260</p> <p><u>Cross References</u> Fram CF10889 Mann CU24004 Micronair MP164 Purflux AH359 Tecocar E652 Fiaam PC8329</p>	<p>CK 24004-C 238 x 194 x 20</p>  <p><u>O/E numbers</u> Hyundai 971332E250 / 9999Z07026</p> <p><u>Cross References</u> Fram..... Mann Micronair..... Purflux..... Tecocar..... Fiaam.....</p>
--	---	--	--

<p>--- Tucson II --- -> left-hand drive</p>  <p>I Il filtro è posizionato nell'abitacolo sul lato conducente</p> <p>GB The filter is located in the passenger compartment on the driver's side</p> <p>F Le filtre est situé dans l'habitacle du côté conducteur</p> <p>D Der Filter befindet sich im Fahrgastraum auf der Fahrerseite</p> <p>E El Filtro se encuentra en el habitáculo, del lado del conductor</p>	<p>06/15 -> * <input type="checkbox"/></p>	<p>CK 24004 238 x 194 x 20</p>  <p><u>O/E numbers</u> Hyundai 971332E250 / 971332E260</p> <p><u>Cross References</u> Fram CF10889 Mann CU24004 Micronair MP164 Purflux AH359 Tecocar E652 Fiaam PC8329</p>	<p>CK 24004-C 238 x 194 x 20</p>  <p><u>O/E numbers</u> Hyundai 971332E250 / 9999Z07026</p> <p><u>Cross References</u> Fram..... Mann Micronair..... Purflux..... Tecocar..... Fiaam.....</p>
---	---	--	--

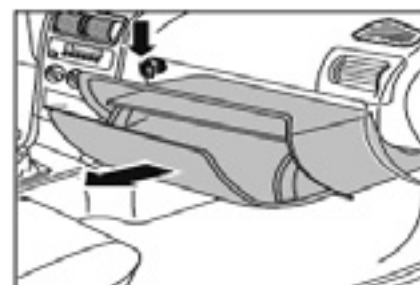
<p>--- Veloster ---</p>  <p>I Il filtro è posizionato nell'abitacolo sul lato conducente</p> <p>GB The filter is located in the passenger compartment on the driver's side</p> <p>F Le filtre est situé dans l'habitacle du côté conducteur</p> <p>D Der Filter befindet sich im Fahrgastraum auf der Fahrerseite</p> <p>E El Filtro se encuentra en el habitáculo, del lado del conductor</p>	<p>08/11 -> * <input type="checkbox"/></p>	<p>CK 2336 225 x 202 x 17</p>  <p><u>O/E numbers</u> Hyundai 9999Z07022 / 087902E200</p> <p><u>Cross References</u> Fram CF10210 Mann CU2336 Micronair MP196 Purflux AH248 Tecocar E451/E460 Fiaam PC8187</p>	<p>---</p>
---	---	---	------------

<p>--- XG ---</p>  <p>I Il filtro è posizionato nell'abitacolo dietro il vano portaoggetti</p> <p>GB The filter is located in the passenger compartment behind the glove compartment</p> <p>F Le filtre est situé dans l'habitacle derrière la boîte à gants</p> <p>D Der filter befindet sich im Fahrgastraum hinter dem Handshuhfach</p> <p>E El filtro se encuentra en el habitáculo detrás de la guantera</p>	<p>04/99 -> <input type="checkbox"/> <input type="checkbox"/></p>	<p>CK 9756 263/252 x 194/189 x 37,5</p>  <p><u>O/E numbers</u> Hyundai 97619-38100 / 9999-07010</p> <p><u>Cross References</u> Fram CF9756 Mann CU2647 Micronair MP204 Purflux AH230 Tecocar E429 Fiaam PC8141</p>	<p>---</p>
--	--	--	------------



<p> </p>	<p> </p>	<p> </p>
----------	----------	----------



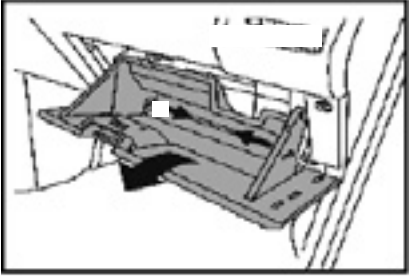

Anti-pollen

Activated carbon

INFINITI

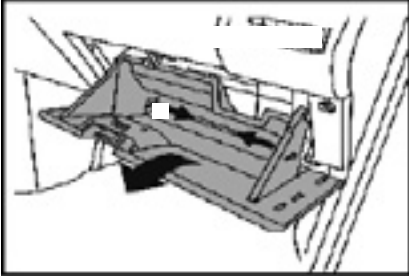
<p>--- FX ---</p>  <ul style="list-style-type: none"> I Il filtro è posizionato nell'abitacolo sotto il vano portaoggetti GB The filter is located in the passenger compartment under the glove compartment F Le filtre est situé dans l'habitacle en dessous de la boîte à gants D Der filter befindet sich im Fahrgastraum unter dem Handshuhfach E El filtro se encuentra en el habitáculo, bajo la guantera de pasajero 	<p>01/03 -> 09/08</p>	<p>CK 9882 216 x 200 x 30</p>  <p><u>O/E numbers</u> Infiniti</p> <p><u>Cross References</u> Fram CF9882 Mann CU2252 Micronair..... Purflux AH298 Tecnocar E454 Fiaam.....</p>	<p>CK 9882-C 216 x 200 x 30</p>  <p><u>O/E numbers</u> Infiniti</p> <p><u>Cross References</u> Fram..... Mann CUK2252 Micronair..... Purflux..... Tecnocar..... Fiaam.....</p>
---	--------------------------	--	---

<p>--- G35 ---</p>  <ul style="list-style-type: none"> I Il filtro è posizionato nell'abitacolo sotto il vano portaoggetti GB The filter is located in the passenger compartment under the glove compartment F Le filtre est situé dans l'habitacle en dessous de la boîte à gants D Der filter befindet sich im Fahrgastraum unter dem Handshuhfach E El filtro se encuentra en el habitáculo, bajo la guantera de pasajero 	<p>10/02 -> 12/06</p>	<p>CK 9882 216 x 200 x 30</p>  <p><u>O/E numbers</u> Infiniti</p> <p><u>Cross References</u> Fram CF9882 Mann CU2252 Micronair..... Purflux AH298 Tecnocar E454 Fiaam PC8152</p>	<p>CK 9882-C 216 x 200 x 30</p>  <p><u>O/E numbers</u> Infiniti</p> <p><u>Cross References</u> Fram..... Mann CUK2252 Micronair..... Purflux..... Tecnocar..... Fiaam.....</p>
--	--------------------------	--	---

--	--	--	--

--	--	--	--

--	--	--	--



Anno di fabbricazione / Year of construction
Année de fabrication / Baujahr / Año de fabricación



Con climatizzatore / With air-conditioning / Avec climatisation
Mit Klimaanlage / Con instalación de aire acondicionado



Senza climatizzatore / Without air-conditioning / Sans climatisation
Ohne Klimaanlage / Sin instalación de aire acondicionado



Anti-pollen

Activated carbon

IVECO

--- Daily III ---

07/99 -> 07/06

*

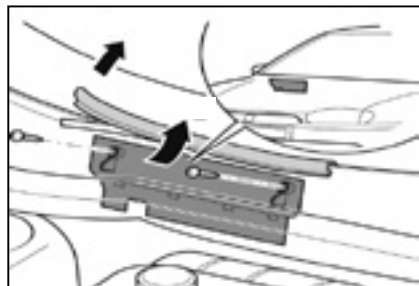

- I Il filtro è posizionato nel vano motore dietro la presa d'aria
- II The filter is located in the engine compartment behind the ventilation grilles
- III Le filtre est situé dans le compartiment moteur derrière les grilles d'aération
- IV Der filter befindet sich im motorraum hinter den Lüftungsgittern
- V El filtro se encuentra en el compartimiento del motor, detrás de la rejilla de ventilación

CK 5819

290 x 160 x 29



O/E numbers

Fiat 46442422 / 46768502

Cross References

Fram CF5819 Mann CU2951/CU2956
Micronair MP039 Purflux AH107
Tecocar E305 Fiaam PC8011

CK 5819-C

290 x 160 x 29



O/E numbers

Fiat 60815647

Cross References

Fram CFA8894 Mann CUK2951/CUK2956
Micronair MC539 Purflux AHC107
Tecocar EC305 Fiaam PCK8068

--- Daily IV ---

07/06 ->

*

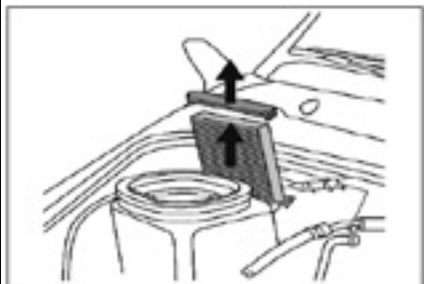

- I Il filtro è posizionato nel vano motore dietro la presa d'aria
- II The filter is located in the engine compartment behind the ventilation grilles
- III Le filtre est situé dans le compartiment moteur derrière les grilles d'aération
- IV Der filter befindet sich im motorraum hinter den Lüftungsgittern
- V El filtro se encuentra en el compartimiento del motor, detrás de la rejilla de ventilación

CK 2952

291 x 191 x 30



O/E numbers

Fiat 3802821

Cross References

Fram CF10597 Mann CU2952
Micronair MP263 Purflux AH279
Tecocar E490 Fiaam PC8255

--- Daily V ---

10/11 ->

*

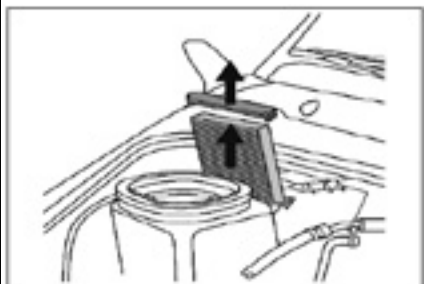

- I Il filtro è posizionato nel vano motore dietro la presa d'aria
- II The filter is located in the engine compartment behind the ventilation grilles
- III Le filtre est situé dans le compartiment moteur derrière les grilles d'aération
- IV Der filter befindet sich im motorraum hinter den Lüftungsgittern
- V El filtro se encuentra en el compartimiento del motor, detrás de la rejilla de ventilación

CK 2952

291 x 191 x 30



O/E numbers

Fiat 3802821

Cross References

Fram CF10597 Mann CU2952
Micronair MP263 Purflux AH279
Tecocar E490 Fiaam PC8255

--- Daily Citis / Recreo / Tourys / Way ---

09/06 ->

*

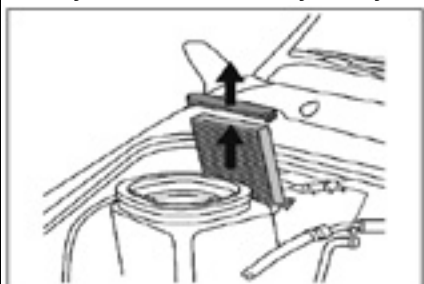

- I Il filtro è posizionato nel vano motore dietro la presa d'aria
- II The filter is located in the engine compartment behind the ventilation grilles
- III Le filtre est situé dans le compartiment moteur derrière les grilles d'aération
- IV Der filter befindet sich im motorraum hinter den Lüftungsgittern
- V El filtro se encuentra en el compartimiento del motor, detrás de la rejilla de ventilación

CK 2952

291 x 191 x 30



O/E numbers

Fiat 3802821

Cross References

Fram CF10597 Mann CU2952
Micronair MP263 Purflux AH279
Tecocar E490 Fiaam PC8255

--- Rapido ---

02/07 ->

*

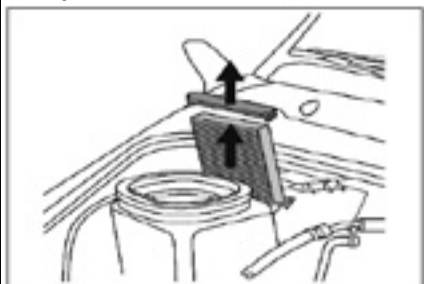

- I Il filtro è posizionato nel vano motore dietro la presa d'aria
- II The filter is located in the engine compartment behind the ventilation grilles
- III Le filtre est situé dans le compartiment moteur derrière les grilles d'aération
- IV Der filter befindet sich im motorraum hinter den Lüftungsgittern
- V El filtro se encuentra en el compartimiento del motor, detrás de la rejilla de ventilación

CK 2952

291 x 191 x 30



O/E numbers

Fiat 3802821

Cross References

Fram CF10597 Mann CU2952
Micronair MP263 Purflux AH279
Tecocar E490 Fiaam PC8255



Anti-pollen

Activated carbon

JAGUAR

--- S-Type ---

01/99 -> 02/08 * *

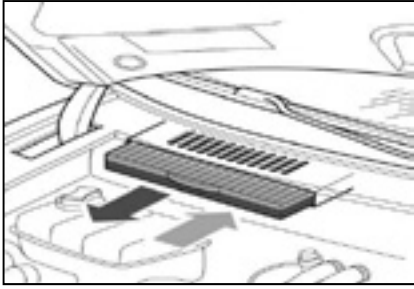

- I Il filtro è posizionato nel vano motore dietro la presa d'aria
- GB The filter is located in the engine compartment behind the ventilation grilles
- F Le filtre est situé dans le compartiment moteur derrière les grilles d'aération
- D Der filter befindet sich im motorraum hinter den Lüftungsgittern
- E El filtro se encuentra en el compartimiento del motor, detrás de la rejilla de ventilación

CK 619-C

250 x 181,5 x 43



O/E numbers

Jaguar XR830254 / XR849025

Cross References

Fram CFA10613 Mann CUK26003
Micronair MC619 Purflux.....
Tecnicar..... Fiaam PCK8227

--- X-Type ---

06/01 -> * *

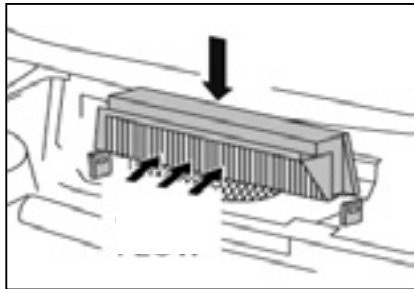

- I Il filtro è posizionato nel vano motore sul lato passeggero sotto il coperchio della vaschetta del radiatore
- GB The filter is located in the engine compartment on the passenger's side under the radiator tank cover
- F Le filtre est situé dans le compartiment moteur du côté passager en dessous du cache du réservoir à eau
- D Der filter befindet sich Motorraum auf der Beifahrerseite unter der Wasserkastenabdeckung
- E El filtro se encuentra en el compartimiento del motor, lado del acompañante, bajo la cubierta del depósito del agua

CK 5664

515/505 x 108/98 x 29,5/34,5



O/E numbers

Jaguar 1X4H16N619 / 1S7H16N619

Cross References

Fram CF5664/CF9534 Mann CU5257/CU5141
Micronair MP076/MP097 Purflux AH103
Tecnicar E312 Fiaam PC8006/PC8099

CK 5664-C

514/504 x 108/98 x 29,5/36



O/E numbers

Jaguar 1X4H19G244 / 1S7H19G244

Cross References

Fram CFA8046/CFA953 Mann CUK5257/CUK5141
Micronair MC576/MC597 Purflux AHC103
Tecnicar..... Fiaam PCK8063/PCK8099

--- XF ---

03/08 -> * *

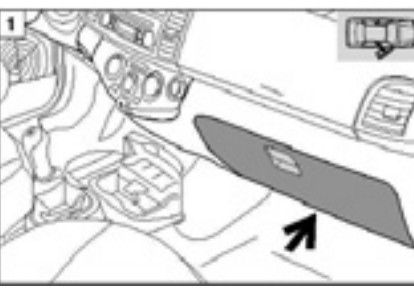

- I Il filtro è posizionato nel vano motore dietro la presa d'aria
- GB The filter is located in the engine compartment behind the ventilation grilles
- F Le filtre est situé dans le compartiment moteur derrière les grilles d'aération
- D Der filter befindet sich im motorraum hinter den Lüftungsgittern
- E El filtro se encuentra en el compartimiento del motor, detrás de la rejilla de ventilación

CK 2030-C

196 x 192 x 30



O/E numbers

Jaguar C2Z6525 / MF1455700380

Cross References

Fram Mann CUK2030
Micronair MC848 Purflux.....
Tecnicar..... Fiaam

--- XJ / XJR (X350) ---

01/10 -> * *

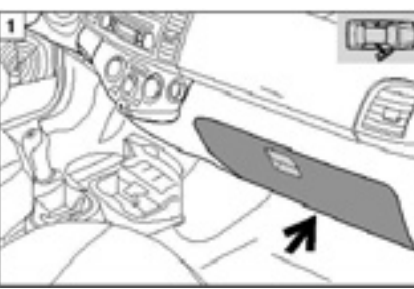

- I Il filtro è posizionato nel vano motore dietro la presa d'aria
- GB The filter is located in the engine compartment behind the ventilation grilles
- F Le filtre est situé dans le compartiment moteur derrière les grilles d'aération
- D Der filter befindet sich im motorraum hinter den Lüftungsgittern
- E El filtro se encuentra en el compartimiento del motor, detrás de la rejilla de ventilación

CK 2030-C

196 x 192 x 30



O/E numbers

Jaguar C2Z6525 / MF1455700380

Cross References









Fram Mann CUK2030
Micronair MC848 Purflux.....
Tecnicar..... Fiaam

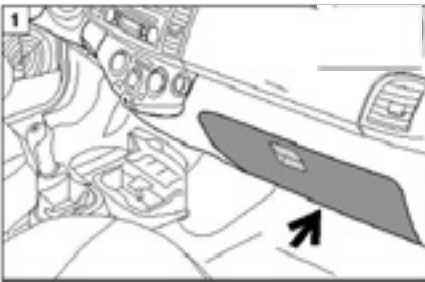
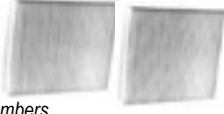
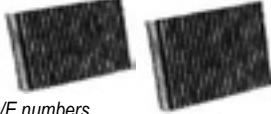
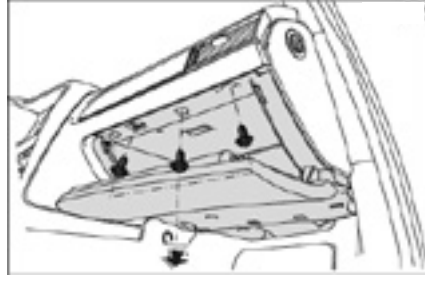

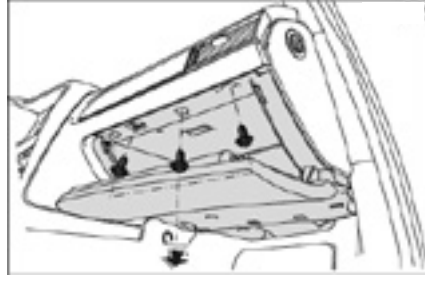
Anti-pollen

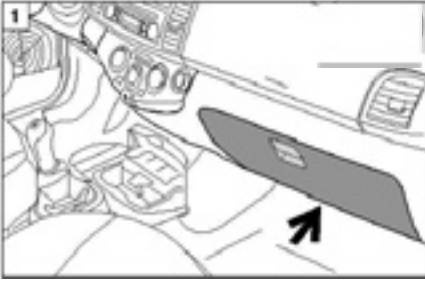
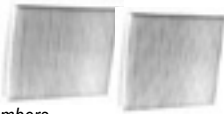
Activated carbon

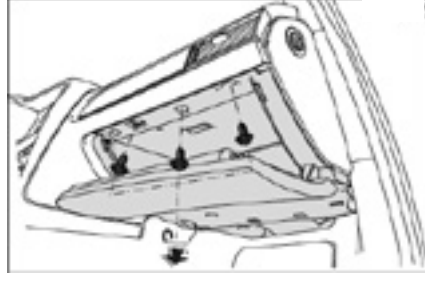
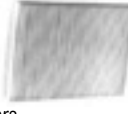
JEEP

<p>--- Cherokee III (KK) ---</p> 	<p>09/07 -> * *</p> <p>Il filtro è posizionato nell'abitacolo dietro il vano portaoggetti The filter is located in the passenger compartment behind the glove compartment Le filtre est situé dans l'habitacle derrière la boîte à gants Der filter befindet sich im Fahrgastraum hinter dem Handshuhfach El filtro se encuentra en el habitáculo detrás de la guantera</p>	<p>CK 1811-2 180 x 90 x 20</p>  <p><u>O/E numbers</u> Chrysler 68033193AA <u>Cross References</u> Fram Mann CU1811-2 Micronair MP402-2 Purflux Tecnocar Fiaam</p>	<p>CK 1811-C-2 180 x 90 x 20</p>  <p><u>O/E numbers</u> Chrysler <u>Cross References</u> Fram Mann Micronair Purflux Tecnocar Fiaam</p>
<p>--- Compass ---</p> 	<p>09/06 -> * *</p> <p>Il filtro è posizionato nell'abitacolo sotto il vano portaoggetti The filter is located in the passenger compartment under the glove compartment Le filtre est situé dans l'habitacle en dessous de la boîte à gants Der filter befindet sich im Fahrgastraum unter dem Handshuhfach El filtro se encuentra en el habitáculo, bajo la guantera de pasajerruimte</p>	<p>CK 2227 216 x 194 x 25</p>  <p><u>O/E numbers</u> Chrysler 05058693AA <u>Cross References</u> Fram CF11444 Mann CU2227 Micronair MP325 Purflux AH365 Tecnocar E659 Fiaam PC8335</p>	<p>CK 2227-C 216 x 194 x 25</p>  <p><u>O/E numbers</u> Chrysler 05058381AA <u>Cross References</u> Fram Mann CUK2227 Micronair MC825 Purflux Tecnocar Fiaam</p>
<p>--- Grand Cherokee IV (WK/WK2) ---</p> 	<p>12/10 -> * *</p> <p>Il filtro è posizionato nell'abitacolo sotto il vano portaoggetti The filter is located in the passenger compartment under the glove compartment Le filtre est situé dans l'habitacle en dessous de la boîte à gants Der filter befindet sich im Fahrgastraum unter dem Handshuhfach El filtro se encuentra en el habitáculo, bajo la guantera de pasajerruimte</p>	<p>CK 27008 216 x 194 x 25</p>  <p><u>O/E numbers</u> Chrysler 68079487AA <u>Cross References</u> Fram CF11183 Mann CU27008 Micronair MP436 Purflux AH361 Tecnocar E654 Fiaam PC8331</p>	<p>---</p>
<p>--- Liberty II ---</p> 	<p>03/08 -> * *</p> <p>Il filtro è posizionato nell'abitacolo dietro il vano portaoggetti The filter is located in the passenger compartment behind the glove compartment Le filtre est situé dans l'habitacle derrière la boîte à gants Der filter befindet sich im Fahrgastraum hinter dem Handshuhfach El filtro se encuentra en el habitáculo detrás de la guantera</p>	<p>CK 1811-2 180 x 90 x 20</p>  <p><u>O/E numbers</u> Chrysler 68033193AA <u>Cross References</u> Fram Mann CU1811-2 Micronair MP402-2 Purflux Tecnocar Fiaam</p>	<p>CK 1811-C-2 180 x 90 x 20</p>  <p><u>O/E numbers</u> Chrysler <u>Cross References</u> Fram Mann Micronair Purflux Tecnocar Fiaam</p>
<p>--- Patriot ---</p> 	<p>10/07 -> * *</p> <p>Il filtro è posizionato nell'abitacolo sotto il vano portaoggetti The filter is located in the passenger compartment under the glove compartment Le filtre est situé dans l'habitacle en dessous de la boîte à gants Der filter befindet sich im Fahrgastraum unter dem Handshuhfach El filtro se encuentra en el habitáculo, bajo la guantera de pasajerruimte</p>	<p>CK 2227 216 x 194 x 25</p>  <p><u>O/E numbers</u> Chrysler 05058693AA <u>Cross References</u> Fram CF11444 Mann CU2227 Micronair MP325 Purflux AH365 Tecnocar E659 Fiaam PC8335</p>	<p>CK 2227-C 216 x 194 x 25</p>  <p><u>O/E numbers</u> Chrysler 05058381AA <u>Cross References</u> Fram Mann CUK2227 Micronair MC825 Purflux Tecnocar Fiaam</p>



Anti-pollen

Activated carbon

JEEP

--- Renegade (BU) ---

07/14 ->

*

CK 77366480

219 x 156,5 x 29,5



CK 77366480-C

405 x 164 x 32



- Il filtro è posizionato nel vano motore sul lato passeggero
- The filter is located in the engine compartment on the passenger's side
- Le filtre est situé dans le compartiment moteur du côté passager
- Der filter befindet sich Motorraum auf der Beifahrerseite
- El filtro se encuentra en el compartimiento del motor, del lado del acompañante

O/E numbers

Fiat 77366480

Cross References

Fram CF11662	Mann CU22022
Micronair MP440	Puflux AH396
Tecnocar E687	Fiaam PC8365

O/E numbers

Fiat 71775824

Cross References

Fram CFA11662	Mann CUK22022
Micronair	Puflux AHC396
Tecnocar EC687	Fiaam PCK8365

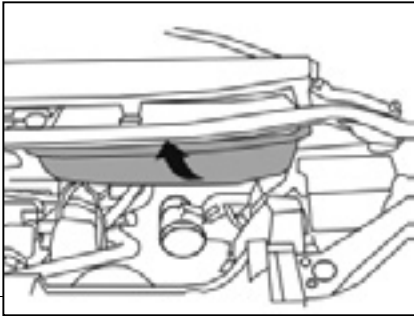

--	--	--

--	--	--

--	--	--

--	--	--



Anti-pollen

Activated carbon

KIA

--- Carens III ---

10/06 -> *



- I** Il filtro è posizionato nell'abitacolo sul lato conducente
- GB** The filter is located in the passenger compartment on the driver's side
- F** Le filtre est situé dans l'habitacle du côté conducteur
- D** Der Filter befindet sich im Fahrgastraum auf der Fahrerseite
- E** El Filtro se encuentra en el habitáculo, del lado del conductor

CK 2336

225 x 202 x 17



O/E numbers

Kia 971332E210

Cross References

Fram CF10210 Mann CU2336
Micronair MP196 Purflux AH248
Iecnocar E451/E460 Fiaam PC8187

--- Carens IV ---

03/13 -> *

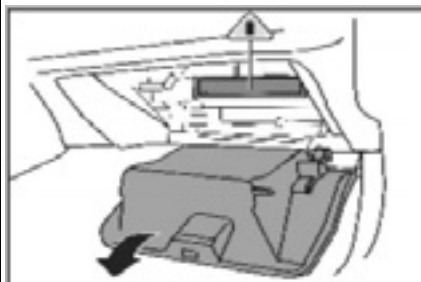

- I** Il filtro è posizionato nell'abitacolo sul lato conducente
- GB** The filter is located in the passenger compartment on the driver's side
- F** Le filtre est situé dans l'habitacle du côté conducteur
- D** Der Filter befindet sich im Fahrgastraum auf der Fahrerseite
- E** El Filtro se encuentra en el habitáculo, del lado del conductor

CK 24013

238 x 198 x 20



O/E numbers

Kia 971332H001 / 971332H001AT

Cross References

Fram Mann CU24013
Micronair MP382 Purflux
Tecocar Fiaam

--- Carnival III ---

06/06 -> *

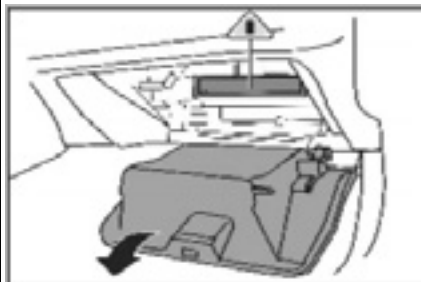

- I** Il filtro è posizionato nell'abitacolo sul lato conducente
- GB** The filter is located in the passenger compartment on the driver's side
- F** Le filtre est situé dans l'habitacle du côté conducteur
- D** Der Filter befindet sich im Fahrgastraum auf der Fahrerseite
- E** El Filtro se encuentra en el habitáculo, del lado del conductor

CK 2434

240 x 211 x 17



O/E numbers

Kia 971332F000 / 971332F000

Cross References

Fram CF10248 Mann CU2434
Micronair MP197 Purflux AH345
Tecocar Fiaam PC8302

CK 2434-C

240 x 211 x 17

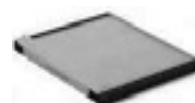

O/E numbers

Kia 971332F000 / 971332E270

Cross References

Fram..... Mann
Micronair..... Purflux.....
Tecocar..... Fiaam.....

--- Cee'd ---

01/07 -> *

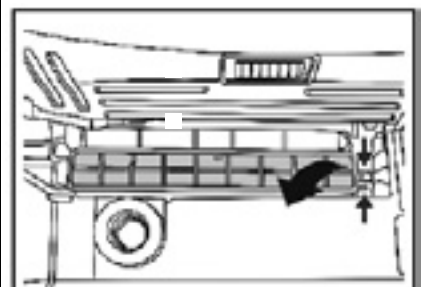

- I** Il filtro è posizionato nell'abitacolo dietro il vano portaoggetti
- GB** The filter is located in the passenger compartment behind the glove compartment
- F** Le filtre est situé dans l'habitacle derrière la boîte à gants
- D** Der filter befindet sich im Fahrgastraum hinter dem Handshuhfach
- E** El filtro se encuentra en el habitáculo detrás de la guantera

CK 2532-10

245 x 172 x 20



O/E numbers

Kia 971331H000 / F1178AP64401

Cross References

Fram CF10471 Mann CU2532/CU2631
Micronair MP269 Purflux AH270
Tecocar E479 Fiaam PC8211

--- Cee'd II ---

05/12 -> *



- I** Il filtro è posizionato nell'abitacolo sul lato conducente
- GB** The filter is located in the passenger compartment on the driver's side
- F** Le filtre est situé dans l'habitacle du côté conducteur
- D** Der Filter befindet sich im Fahrgastraum auf der Fahrerseite
- E** El Filtro se encuentra en el habitáculo, del lado del conductor

CK 24013

238 x 198 x 20



O/E numbers

Kia 971332H001 / 971332H001AT

Cross References

Fram Mann CU24013
Micronair MP382 Purflux
Tecocar Fiaam



Anti-pollen

Activated carbon

KIA

--- Cerato I ---

04/04 -> *

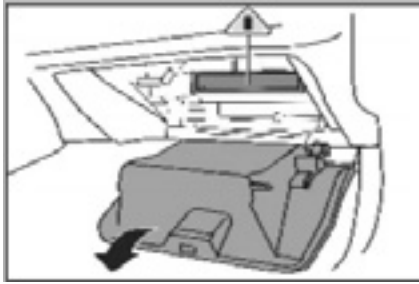

- I** Il filtro è posizionato nell'abitacolo sul lato conducente
- GB** The filter is located in the passenger compartment on the driver's side
- F** Le filtre est situé dans l'habitacle du côté conducteur
- D** Der Filter befindet sich im Fahrgastraum auf der Fahrerseite
- E** El Filtro se encuentra en el habitáculo, del lado del conductor

CK 2434

240 x 211 x 17



O/E numbers

Kia 971332F000 / 971332F000

Cross References

Fram CF10248 Mann CU2434
Micronair MP197 Purflux AH345
Tecnocar Fiaam PC8302

CK 2434-C

240 x 211 x 17

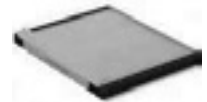

O/E numbers

Kia 971332F000 / 971332E270

Cross References

Fram..... Mann
Micronair..... Purflux.....
Tecnocar..... Fiaam.....

--- Cerato II ---

10/06 -> *

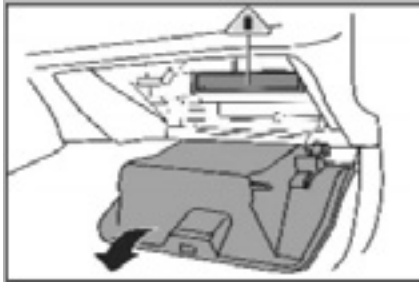

- I** Il filtro è posizionato nell'abitacolo sul lato conducente
- GB** The filter is located in the passenger compartment on the driver's side
- F** Le filtre est situé dans l'habitacle du côté conducteur
- D** Der Filter befindet sich im Fahrgastraum auf der Fahrerseite
- E** El Filtro se encuentra en el habitáculo, del lado del conductor

CK 2336

225 x 202 x 17



O/E numbers

Kia 971332E210

Cross References

Fram CF10210 Mann CU2336
Micronair MP196 Purflux AH248
Tecnocar E451/E460 Fiaam PC8187

--- Cerato Koup / Forte Koup ---

09/08 -> *

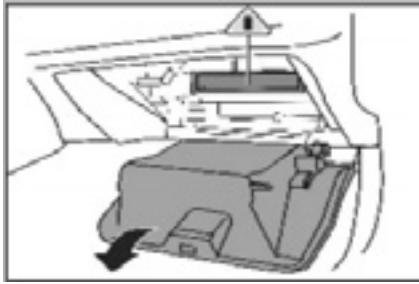

- I** Il filtro è posizionato nell'abitacolo sul lato conducente
- GB** The filter is located in the passenger compartment on the driver's side
- F** Le filtre est situé dans l'habitacle du côté conducteur
- D** Der Filter befindet sich im Fahrgastraum auf der Fahrerseite
- E** El Filtro se encuentra en el habitáculo, del lado del conductor

CK 2336

225 x 202 x 17



O/E numbers

Kia 971332E210

Cross References

Fram CF10210 Mann CU2336
Micronair MP196 Purflux AH248
Tecnocar E451/E460 Fiaam PC8187

--- Grand Carnival (VQ) ---

06/06 -> *



- I** Il filtro è posizionato nell'abitacolo sul lato conducente
- GB** The filter is located in the passenger compartment on the driver's side
- F** Le filtre est situé dans l'habitacle du côté conducteur
- D** Der Filter befindet sich im Fahrgastraum auf der Fahrerseite
- E** El Filtro se encuentra en el habitáculo, del lado del conductor

CK 2434

240 x 211 x 17

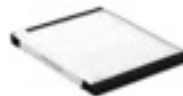

O/E numbers

Kia 971332F000 / 971332F000

Cross References

Fram CF10248 Mann CU2434
Micronair MP197 Purflux AH345
Tecnocar Fiaam PC8302

CK 2434-C

240 x 211 x 17



O/E numbers

Kia 971332F000 / 971332E270

Cross References

Fram..... Mann
Micronair..... Purflux.....
Tecnocar..... Fiaam.....

--- Magentis ---

03/01 -> 02/06 *

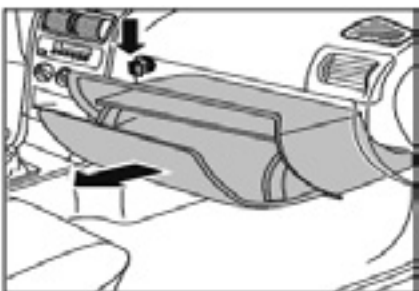

- I** Il filtro è posizionato nell'abitacolo dietro il vano portaoggetti
- GB** The filter is located in the passenger compartment behind the glove compartment
- F** Le filtre est situé dans l'habitacle derrière la boîte à gants
- D** Der filter befindet sich im Fahrgastraum hinter dem Handschuhfach
- E** El filtro se encuentra en el habitáculo detrás de la guantera

CK 9756

263/252 x 194/189 x 37,5



O/E numbers

Kia 97619-38100

Cross References

Fram CF9756 Mann CU2647
Micronair MP204 Purflux AH230
Tecnocar E429 Fiaam PC8141





Anti-pollen

Activated carbon

KIA

--- Mohave ---

01/08 -> *



- I** Il filtro è posizionato nell'abitacolo sul lato conducente
- CH** The filter is located in the passenger compartment on the driver's side
- F** Le filtre est situé dans l'habitacle du côté conducteur
- D** Der Filter befindet sich im Fahrgastraum auf der Fahrerseite
- E** El Filtro se encuentra en el habitáculo, del lado del conductor

CK 2434

240 x 211 x 17



O/E numbers

Kia 971332F000 / 971332F000

Cross References

Fram CF10248 Mann CU2434
Micronair MP197 Purflux AH345
Tecnocar Fiaam PC8302

CK 2434-C

240 x 211 x 17

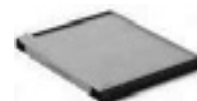

O/E numbers

Kia 971332F000 / 971332E270

Cross References

Fram..... Mann
Micronair..... Purflux.....
Tecnocar..... Fiaam.....

--- Optima (TF) ---

03/12 -> *

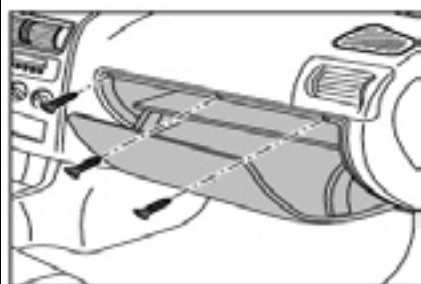

- I** Il filtro è posizionato nell'abitacolo dietro il vano portaoggetti
- CH** The filter is located in the passenger compartment behind the glove compartment
- F** Le filtre est situé dans l'habitacle derrière la boîte à gants
- D** Der filter befindet sich im Fahrgastraum hinter dem Handshuhfach
- E** El filtro se encuentra en el habitáculo detrás de la guantera

CK 26017

253,5 x 225 x 20



O/E numbers

Kia 971333SAA0 / 971333SAA0AT

Cross References

Fram CF11178 Mann CU26017
Micronair Purflux AH406
Tecnocar E697 Fiaam PC8376

CK 26017-C

253,5 x 225 x 20



O/E numbers

Kia

Cross References

Fram..... Mann CUK26017
Micronair Purflux.....
Tecnocar..... Fiaam.....

--- Picanto I (BA) ---

04/04 -> 05/11 *



- I** Il filtro è posizionato nell'abitacolo dietro il vano portaoggetti
- CH** The filter is located in the passenger compartment behind the glove compartment
- F** Le filtre est situé dans l'habitacle derrière la boîte à gants
- D** Der filter befindet sich im Fahrgastraum hinter dem Handshuhfach
- E** El filtro se encuentra en el habitáculo detrás de la guantera

CK 1910

186/181 x 187/177 x 12/14



O/E numbers

Kia 9713307000 - 971330X900

Cross References

Fram CF10627 Mann CU1910
Micronair MP220 Purflux AH301
Tecnocar E496 Fiaam PC8248

CK 1910-C

186/181 x 187/177 x 12/14



O/E numbers

Kia

Cross References

Fram..... Mann
Micronair..... Purflux.....
Tecnocar..... Fiaam.....

--- Picanto II (TA) ---

06/11 -> *

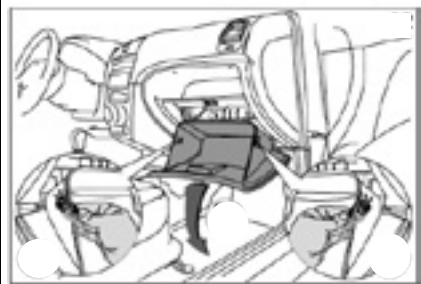

- I** Il filtro è posizionato nell'abitacolo dietro il vano portaoggetti
- CH** The filter is located in the passenger compartment behind the glove compartment
- F** Le filtre est situé dans l'habitacle derrière la boîte à gants
- D** Der filter befindet sich im Fahrgastraum hinter dem Handshuhfach
- E** El filtro se encuentra en el habitáculo detrás de la guantera

CK 1910

186/181 x 187/177 x 12/14



O/E numbers

Kia 9713307000 - 971330X900

Cross References

Fram CF10627 Mann CU1910
Micronair MP220 Purflux AH301
Tecnocar E496 Fiaam PC8248

CK 1910-C

186/181 x 187/177 x 12/14



O/E numbers

Kia

Cross References

Fram..... Mann
Micronair..... Purflux.....
Tecnocar..... Fiaam.....

--- Rio II (JB) ---

09/08 -> *



- I** Il filtro è posizionato nell'abitacolo sul lato conducente
- CH** The filter is located in the passenger compartment on the driver's side
- F** Le filtre est situé dans l'habitacle du côté conducteur
- D** Der Filter befindet sich im Fahrgastraum auf der Fahrerseite
- E** El Filtro se encuentra en el habitáculo, del lado del conductor

CK 2336

225 x 202 x 17



O/E numbers

Kia 971332E210

Cross References

Fram CF10210 Mann CU2336
Micronair MP196 Purflux AH248
Tecnocar E451/E460 Fiaam PC8187



Anti-pollen

Activated carbon

KIA

--- Rio III (UB) ---

09/08 ->

*



- I** Il filtro è posizionato nell'abitacolo sul lato conducente
- GB** The filter is located in the passenger compartment on the driver's side
- F** Le filtre est situé dans l'habitacle du côté conducteur
- D** Der Filter befindet sich im Fahrgastraum auf der Fahrerseite
- E** El Filtro se encuentra en el habitáculo, del lado del conductor

CK 2336

225 x 202 x 17



O/E numbers

Kia 971332E210

Cross References

Fram CF10210 Mann CU2336
Micronair MP196 Purflux AH248
Iecnocar E451/E460 Fiaam PC8187

--- Sorento I (JC) ---

07/02 ->

*

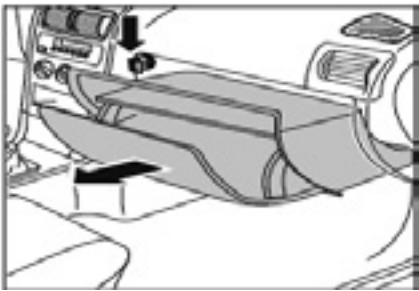

- I** Il filtro è posizionato nell'abitacolo dietro il vano portaoggetti
- GB** The filter is located in the passenger compartment behind the glove compartment
- F** Le filtre est situé dans l'habitacle derrière la boîte à gants
- D** Der filter befindet sich im Fahrgastraum hinter dem Handsuhfach
- E** El filtro se encuentra en el habitáculo detrás de la guantera

CK 9756

263/252 x 194/189 x 37,5



O/E numbers

Kia 97619-38100

Cross References

Fram CF9756 Mann CU2647
Micronair MP204 Purflux AH230
Tecocar E429 Fiaam PC8141

--- Sorento II (XM) ---

11/09 ->

*



- I** Il filtro è posizionato nell'abitacolo sul lato conducente
- GB** The filter is located in the passenger compartment on the driver's side
- F** Le filtre est situé dans l'habitacle du côté conducteur
- D** Der Filter befindet sich im Fahrgastraum auf der Fahrerseite
- E** El Filtro se encuentra en el habitáculo, del lado del conductor

CK 2434

240 x 211 x 17



O/E numbers

Kia 971332F000 / 971332F000

Cross References

Fram CF10248 Mann CU2434
Micronair MP197 Purflux AH345
Tecocar Fiaam PC8302

CK 2434-C

240 x 211 x 17

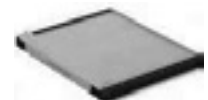

O/E numbers

Kia 971332F000 / 971332E270

Cross References

Fram..... Mann
Micronair..... Purflux.....
Tecocar..... Fiaam.....

--- Soul ---

02/09 ->

*

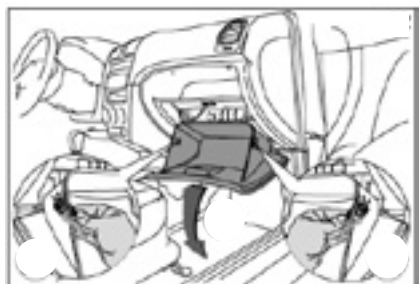

- I** Il filtro è posizionato nell'abitacolo dietro il vano portaoggetti
- GB** The filter is located in the passenger compartment behind the glove compartment
- F** Le filtre est situé dans l'habitacle derrière la boîte à gants
- D** Der filter befindet sich im Fahrgastraum hinter dem Handsuhfach
- E** El filtro se encuentra en el habitáculo detrás de la guantera

CK 19001

182 x 159 x 25



O/E numbers

Kia 971332K000

Cross References

Fram CF10776 Mann CU19001
Micronair MP368 Purflux AH287
Tecocar E604 Fiaam PC8256

--- Soul II (PS) ---

02/14 ->

*



- I** Il filtro è posizionato nell'abitacolo dietro il vano portaoggetti
- GB** The filter is located in the passenger compartment behind the glove compartment
- F** Le filtre est situé dans l'habitacle derrière la boîte à gants
- D** Der filter befindet sich im Fahrgastraum hinter dem Handsuhfach
- E** El filtro se encuentra en el habitáculo detrás de la guantera

CK 21009

210 x 164 x 25



O/E numbers

Kia 97133B2000

Cross References

Fram CF9408 Mann CU21009
Micronair Purflux AH201
Tecocar E403 Fiaam PC8093











Anti-pollen

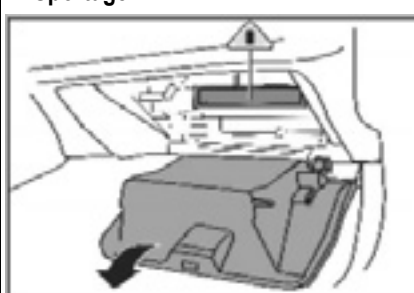

Activated carbon

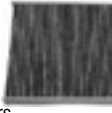

KIA

<p>--- Sportage II --- Left-hand drive</p> 	<p>12/04 -> 03/07 * <input type="checkbox"/></p> <p>I Il filtro è posizionato nell'abitacolo sul lato conducente</p> <p>GB The filter is located in the passenger compartment on the driver's side</p> <p>F Le filtre est situé dans l'habitacle du côté conducteur</p> <p>D Der Filter befindet sich im Fahrgastraum auf der Fahrerseite</p> <p>E El Filtro se encuentra en el habitáculo, del lado del conductor</p>	<p>CK 2336 225 x 202 x 17</p>  <p><u>O/E numbers</u> Kia 9999Z07022 / 087902E200</p> <p><u>Cross References</u> Fram CF10210 Mann CU2336 Micronair MP196 Purflux AH248 Iecnocar E451/E460 Fiaam PC8187</p>	<p>---</p>
--	--	--	------------

<p>--- Sportage II ---</p> 	<p>04/07 -> 07/10 * <input type="checkbox"/></p> <p>I Il filtro è posizionato nell'abitacolo sul lato conducente</p> <p>GB The filter is located in the passenger compartment on the driver's side</p> <p>F Le filtre est situé dans l'habitacle du côté conducteur</p> <p>D Der Filter befindet sich im Fahrgastraum auf der Fahrerseite</p> <p>E El Filtro se encuentra en el habitáculo, del lado del conductor</p>	<p>CK 24004 238 x 194 x 20</p>  <p><u>O/E numbers</u> Kia 971332E250 / 971332E260</p> <p><u>Cross References</u> Fram CF10889 Mann CU24004 Micronair MP164 Purflux AH359 Tecnocar E652 Fiaam PC8329</p>	<p>CK 24004-C 238 x 194 x 20</p>  <p><u>O/E numbers</u> Kia</p> <p><u>Cross References</u> Fram..... Mann</p>
--	--	---	--

<p>--- Sportage III --- vehicle manufact.Slovakia+Russia</p> 	<p>08/10 -> * *</p> <p>I Il filtro è posizionato nell'abitacolo sul lato conducente</p> <p>GB The filter is located in the passenger compartment on the driver's side</p> <p>F Le filtre est situé dans l'habitacle du côté conducteur</p> <p>D Der Filter befindet sich im Fahrgastraum auf der Fahrerseite</p> <p>E El Filtro se encuentra en el habitáculo, del lado del conductor</p>	<p>CK 2336 225 x 202 x 17</p>  <p><u>O/E numbers</u> Kia 9999Z07022 / 087902E200</p> <p><u>Cross References</u> Fram CF10210 Mann CU2336 Micronair MP196 Purflux AH248 Iecnocar E451/E460 Fiaam PC8187</p>	<p>---</p>
--	---	--	------------

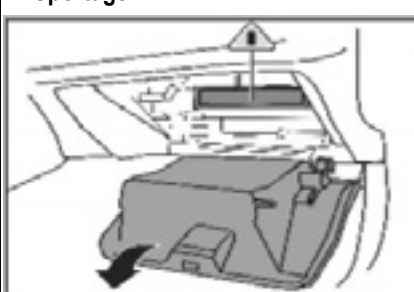
<p>--- Sportage III --- vehicle manufact.Korea</p> 	<p>08/10 -> * *</p> <p>I Il filtro è posizionato nell'abitacolo sul lato conducente</p> <p>GB The filter is located in the passenger compartment on the driver's side</p> <p>F Le filtre est situé dans l'habitacle du côté conducteur</p> <p>D Der Filter befindet sich im Fahrgastraum auf der Fahrerseite</p> <p>E El Filtro se encuentra en el habitáculo, del lado del conductor</p>	<p>CK 24004 238 x 194 x 20</p>  <p><u>O/E numbers</u> Kia 971332E250 / 971332E260</p> <p><u>Cross References</u> Fram CF10889 Mann CU24004 Micronair MP164 Purflux AH359 Tecnocar E652 Fiaam PC8329</p>	<p>CK 24004-C 238 x 194 x 20</p>  <p><u>O/E numbers</u> Kia</p> <p><u>Cross References</u> Fram..... Mann</p>
--	---	---	--

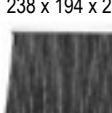
<p>--- Sportage IV ---</p> 	<p>01/16 -> * *</p> <p>I Il filtro è posizionato nell'abitacolo sul lato conducente</p> <p>GB The filter is located in the passenger compartment on the driver's side</p> <p>F Le filtre est situé dans l'habitacle du côté conducteur</p> <p>D Der Filter befindet sich im Fahrgastraum auf der Fahrerseite</p> <p>E El Filtro se encuentra en el habitáculo, del lado del conductor</p>	<p>CK 24004 238 x 194 x 20</p>  <p><u>O/E numbers</u> Kia 971332E250 / 971332E260</p> <p><u>Cross References</u> Fram CF10889 Mann CU24004 Micronair MP164 Purflux AH359 Tecnocar E652 Fiaam PC8329</p>	<p>CK 24004-C 238 x 194 x 20</p>  <p><u>O/E numbers</u> Kia</p> <p><u>Cross References</u> Fram..... Mann</p>
--	---	---	--



Anti-pollen

Activated carbon

KIA

--- Venga ---

02/10 ->

*

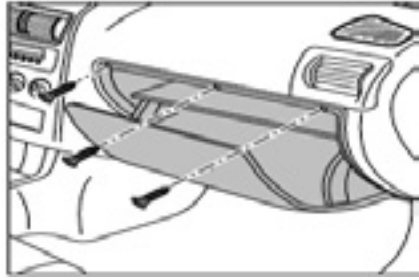

- Il filtro è posizionato nell'abitacolo dietro il vano portaoggetti
- The filter is located in the passenger compartment behind the glove compartment
- Le filtre est situé dans l'habitacle derrière la boîte à gants
- Der filter befindet sich im Fahrgastraum hinter dem Handshuhfach
- El filtro se encuentra en el habitáculo detrás de la guantera

CK 23010

230 x 180 x 20



O/E numbers

Kia 971331P000

Cross References

Fram CF10939

Mann CU23010

Micronair MP320

Purfkux AH332

Tecnocar E626

Fiaam PC8291

CK 23010-C

230 x 180 x 20



O/E numbers

Kia

Cross References

Fram.....

Mann.....

Micronair

Purfkux.....

Tecnocar.....

Fiaam.....

--	--	--

--	--	--

--	--	--

--	--	--



Anti-pollen

Activated carbon

LANCIA

<p>--- Dedra ---</p>	01/89 -> 07/99	*		<p>CK 5823 385 x 173 x 20</p> <p><u>O/E numbers</u> Lancia 46409630 / 60812197</p> <p><u>Cross References</u> Fram CF5823 Mann CU3942 Micronair MP050 Purflux AH110/AH121 Tecocar E314 Fiaam PC8013</p>	<p>CK 5823-C 385 x 173 x 20</p> <p><u>O/E numbers</u> Lancia 46721923</p> <p><u>Cross References</u> Fram CFA8881 Mann..... Micronair MC550 Purflux..... Tecocar..... Fiaam PCK8070</p>
	<p>Il filtro è posizionato nel vano motore dietro la presa d'aria</p> <p>The filter is located in the engine compartment behind the ventilation grilles</p> <p>Le filtre est situé dans le compartiment moteur derrière les grilles d'aération</p> <p>Der filter befindet sich im Motorraum hinter den Lüftungsgittern</p> <p>El filtro se encuentra en el compartimiento del motor, detrás de la rejilla de ventilación</p>				

<p>--- Delta II ---</p>	06/93 -> 08/99	*		<p>CK 5823 385 x 173 x 20</p> <p><u>O/E numbers</u> Lancia 46409630 / 60812197</p> <p><u>Cross References</u> Fram CF5823 Mann CU3942 Micronair MP050 Purflux AH110/AH121 Tecocar E314 Fiaam PC8013</p>	<p>CK 5823-C 385 x 173 x 20</p> <p><u>O/E numbers</u> Lancia 46721923</p> <p><u>Cross References</u> Fram CFA8881 Mann..... Micronair MC550 Purflux..... Tecocar..... Fiaam PCK8070</p>
	<p>Il filtro è posizionato nel vano motore dietro la presa d'aria</p> <p>The filter is located in the engine compartment behind the ventilation grilles</p> <p>Le filtre est situé dans le compartiment moteur derrière les grilles d'aération</p> <p>Der filter befindet sich im Motorraum hinter den Lüftungsgittern</p> <p>El filtro se encuentra en el compartimiento del motor, detrás de la rejilla de ventilación</p>				

<p>--- Delta III ---</p>	06/08 ->	*		<p>CK 9533 232 x 177,5 x 20</p> <p><u>O/E numbers</u> Lancia 46723435</p> <p><u>Cross References</u> Fram CF9533 Mann CU2422 Micronair MP096 Purflux AH190 Tecocar E393 Fiaam PC8100</p>	<p>CK 9533-C 232 x 177,5 x 20</p> <p><u>O/E numbers</u> Lancia 46723435</p> <p><u>Cross References</u> Fram CFA9533 Mann CUK2422 Micronair MC596 Purflux AHC190 Tecocar EC393 Fiaam PCK8100</p>
	<p>Il filtro è posizionato nell'abitacolo sotto il vano portaoggetti</p> <p>The filter is located in the passenger compartment under the glove compartment</p> <p>Le filtre est situé dans l'habitacle en dessous de la boîte à gants</p> <p>Der filter befindet sich im Fahrgastraum unter dem Handsuhfach</p> <p>El filtro se encuentra en el habitáculo, bajo la guanterain de pasajerruimte</p>				

<p>--- Compass ---</p>	09/06 ->	*	*	<p>CK 2227 216 x 194 x 25</p> <p><u>O/E numbers</u> Fiat K05058693AA</p> <p><u>Cross References</u> Fram CF11444 Mann CU2227 Micronair MP325 Purflux AH365 Tecocar E659 Fiaam PC8335</p>	<p>CK 2227-C 216 x 194 x 25</p> <p><u>O/E numbers</u> Fiat K05058381AA</p> <p><u>Cross References</u> Fram Mann CUK2227 Micronair MC825 Purflux Tecocar Fiaam</p>
	<p>Il filtro è posizionato nell'abitacolo sotto il vano portaoggetti</p> <p>The filter is located in the passenger compartment under the glove compartment</p> <p>Le filtre est situé dans l'habitacle en dessous de la boîte à gants</p> <p>Der filter befindet sich im Fahrgastraum unter dem Handsuhfach</p> <p>El filtro se encuentra en el habitáculo, bajo la guanterain de pasajerruimte</p>				

<p>--- Kappa ---</p>	06/96 -> 10/01	*		<p>CK 5851 293 x 225 x 20</p> <p><u>O/E numbers</u> Lancia 46721047</p> <p><u>Cross References</u> Fram CF5851 Mann CU3042 Micronair MP016 Purflux AH111 Tecocar E303 Fiaam PC8025</p>	<p>CK 5851-C 293 x 225 x 20</p> <p><u>O/E numbers</u> Lancia 46722335 / 512024302</p> <p><u>Cross References</u> Fram CFA8788 Mann CUK3042 Micronair MC591 Purflux AHC156 Tecocar EC355 Fiaam PCK8036</p>
	<p>Il filtro è posizionato nel vano motore sul lato passeggero</p> <p>The filter is located in the engine compartment on the passenger's side</p> <p>Le filtre est situé dans le compartiment moteur du côté passager</p> <p>Der filter befindet sich im Motorraum auf der Beifahrerseite</p> <p>El filtro se encuentra en el compartimiento del motor, del lado del acompañante</p>				



Anti-pollen

Activated carbon

LANCIA

--- Kappa Coupé ---

07/96 -> 04/01 *

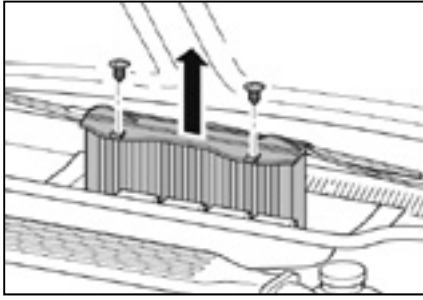

- I** Il filtro è posizionato nel vano motore sul lato passeggero
- GB** The filter is located in the engine compartment on the passenger's side
- F** Le filtre est situé dans le compartiment moteur du côté passager
- D** Der filter befindet sich Motorraum auf der Beifahrerseite
- E** El filtro se encuentra en el compartimiento del motor, del lado del acompañante

CK 5851

293 x 225 x 20



O/E numbers

Lancia 46721047

Cross References

Fram CF5851 Mann CU3042
Micronair MP016 Purflux AH111
Tecocar E303 Fiaam PC8025

CK 5851-C

293 x 225 x 20



O/E numbers

Lancia 46722335 / 512024302

Cross References

Framm CFA8788 Mann CUK3042
Micronair MC591 Purflux AHC156
Tecocar EC355 Fiaam PCK8036

--- Lybra ---

09/99 -> *

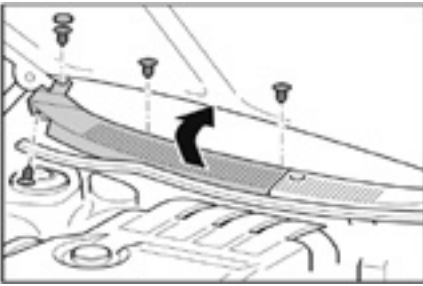

- I** Il filtro è posizionato nel vano motore dietro la presa d'aria
- GB** The filter is located in the engine compartment behind the ventilation grilles
- F** Le filtre est situé dans le compartiment moteur derrière les grilles d'aération
- D** Der filter befindet sich im Motorraum hinter den Lüftungsgittern
- E** El filtro se encuentra en el compartimiento del motor, detrás de la rejilla de ventilación

CK 5819

290 x 160 x 29



O/E numbers

Lancia 60653641

Cross References

Fram CF5819 Mann CU2951/CU2956
Micronair MP039 Purflux AH107
Tecocar E305 Fiaam PC8011

CK 5819-C

290 x 160 x 29



O/E numbers

Lancia 60815647

Cross References

Fram CFA8894 Mann CUK2951/CUK2956
Micronair MC539 Purflux AHC107
Tecocar EC305 Fiaam PCK8068

--- Musa ---

01/04 -> *

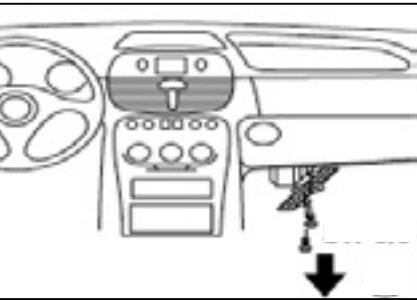

- I** Il filtro è posizionato nell'abitacolo dietro il vano portaoggetti
- GB** The filter is located in the passenger compartment behind the glove compartment
- F** Le filtre est situé dans l'habitacle derrière la boîte à gants
- D** Der filter befindet sich im Fahrgastraum hinter dem Handschuhfach
- E** El filtro se encuentra en el habitáculo detrás de la guantera

CK 9408

215 x 162,5 x 25



O/E numbers

Lancia 46723331

Cross References

Fram CF9408 Mann CU2335
Micronair MP078 Purflux AH201
Tecocar E403 Fiaam PC8093

CK 9408-C

231/220 x 215 x 30



O/E numbers

Lancia 46722862 / 46722863

Cross References

Fram CFA9408 Mann CUK2335
Micronair MC578 Purflux AHC154
Tecocar EC358 Fiaam PCK8093

--- Musa ---

01/04 -> *

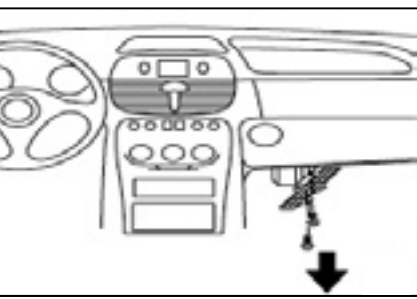

- I** Il filtro è posizionato nell'abitacolo dietro il vano portaoggetti
- GB** The filter is located in the passenger compartment behind the glove compartment
- F** Le filtre est situé dans l'habitacle derrière la boîte à gants
- D** Der filter befindet sich im Fahrgastraum hinter dem Handschuhfach
- E** El filtro se encuentra en el habitáculo detrás de la guantera

CK 9408

215 x 162,5 x 25



O/E numbers

Lancia 46723331 / 77362394

Cross References

Fram CF9408 Mann CU2335
Micronair MP078 Purflux AH201
Tecocar E403 Fiaam PC8093

CK 9408/1-C

215 x 162,5 x 25



O/E numbers

Lancia 46723331

Cross References

Fram Mann
Micronair Purflux
Tecocar Fiaam

--- Phedra ---

09/02 -> *

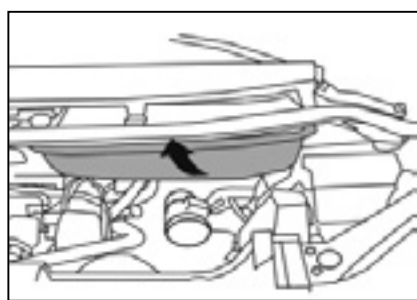

- I** Il filtro è posizionato nel vano motore sul lato passeggero
- GB** The filter is located in the engine compartment on the passenger's side
- F** Le filtre est situé dans le compartiment moteur du côté passager
- D** Der filter befindet sich Motorraum auf der Beifahrerseite
- E** El filtro se encuentra en el compartimiento del motor, del lado del acompañante

CK 9586

405 x 164 x 32



O/E numbers

Lancia 1484383080

Cross References

Fram CF9586 Mann CU4179
Micronair MP116 Purflux AH205
Tecocar E408 Fiaam PC8108

CK 9586-C

405 x 164 x 32



O/E numbers

Lancia 9655190480

Cross References

Fram CFA10307 Mann CUK4179
Micronair MC616 Purflux AHC205
Tecocar EC408 Fiaam PCK8190



Anti-pollen

Activated carbon

LANCIA

<p>--- Thema ---</p>	<p>03/87 -> 07/94</p> <p>*</p>	<p>CK 5841</p> <p>286 x 224 x 13</p> <p><u>O/E numbers</u> Lancia 82398550</p> <p><u>Cross References</u> Fram CF5841 Mann CU3136 Micronair MP027 Purflux AH109 Tecocar E304 Fiaam PC8008</p>
<p>Il filtro è posizionato nel vano motore sul lato passeggero</p> <p>The filter is located in the engine compartment on the passenger's side</p> <p>Le filtre est situé dans le compartiment moteur du côté passager</p> <p>Der filter befindet sich Motorraum auf der Beifahrerseite</p> <p>El filtro se encuentra en el compartimiento del motor, del lado del acompañante</p>		

<p>--- Thesis ---</p>	<p>04/02 -></p> <p>*</p>	<p>CK 9930-C</p> <p>315 x 191 x 30</p> <p><u>O/E numbers</u> Lancia 46723024</p> <p><u>Cross References</u> Fram CFA9930 Mann CUK3241 Micronair MC598 Purflux AHC200 Tecocar EC402 Fiaam PCK8156</p>
<p>Il filtro è posizionato nell'abitacolo sul lato conducente</p> <p>The filter is located in the passenger compartment on the driver's side</p> <p>Le filtre est situé dans l'habitacle du côté conducteur</p> <p>Der Filter befindet sich im Fahrgastraum auf der Fahrerseite</p> <p>El Filtro se encuentra en el habitáculo, del lado del conductor</p>		

<p>--- Voyager ---</p>	<p>10/11 -></p> <p>*</p> <p>*</p>	<p>CK 23003</p> <p>230 x 200 x 30</p> <p><u>O/E numbers</u> Fiat K68042866AA / K68127809AA</p> <p><u>Cross References</u> Fram CF11676 Mann CU23003 Micronair Purflux AH398 Tecocar E689 Fiaam PC8367</p>
<p>Il filtro è posizionato nell'abitacolo sotto il vano portaoggetti</p> <p>The filter is located in the passenger compartment under the glove compartment</p> <p>Le filtre est situé dans l'habitacle en dessous de la boîte à gants</p> <p>Der filter befindet sich im Fahrgastraum unter dem Handsuhfah</p> <p>El filtro se encuentra en el habitáculo, bajo la guantera de pasajerruimte</p>		

<p>--- Y ---</p>	<p>03/96 -> 11/03</p> <p>*</p>	<p>CK 5818</p> <p>309 x 140 x 17,5</p> <p><u>O/E numbers</u> Lancia 46721374</p> <p><u>Cross References</u> Fram CF5818 Mann CU3138 Micronair MP021 Purflux AH108 Tecocar E302 Fiaam PC8014</p>	<p>CK 5818-C</p> <p>309 x 140 x 17,5</p> <p><u>O/E numbers</u> Lancia 46721371</p> <p><u>Cross References</u> Fram Mann Micronair MC521 Purflux Tecocar Fiaam</p>
<p>Il filtro è posizionato nel vano motore dietro la presa d'aria</p> <p>The filter is located in the engine compartment behind the ventilation grilles</p> <p>Le filtre est situé dans le compartiment moteur derrière les grilles d'aération</p> <p>Der filter befindet sich im Motorraum hinter den Lüftungsgittern</p> <p>El filtro se encuentra en el compartimiento del motor, detrás de la rejilla de ventilación</p>			

<p>--- Ypsilon ---</p>	<p>09/03 -></p> <p>*</p>	<p>CK 9408</p> <p>215 x 162,5 x 25</p> <p><u>O/E numbers</u> Lancia 46723331</p> <p><u>Cross References</u> Fram CF9408 Mann CU2335 Micronair MP078 Purflux AH201 Tecocar E403 Fiaam PC8093</p>	<p>CK 9408-C</p> <p>231/220 x 215 x 30</p> <p><u>O/E numbers</u> Lancia 46722862 / 46722863</p> <p><u>Cross References</u> Fram CFA9408 Mann CUK2335 Micronair MC578 Purflux AHC154 Tecocar EC358 Fiaam PCK8093</p>
<p>Il filtro è posizionato nell'abitacolo dietro il vano portaoggetti</p> <p>The filter is located in the passenger compartment behind the glove compartment</p> <p>Le filtre est situé dans l'habitacle derrière la boîte à gants</p> <p>Der filter befindet sich im Fahrgastraum hinter dem Handsuhfah</p> <p>El filtro se encuentra en el habitáculo detrás de la guantera</p>			



Anti-pollen

Activated carbon

LANCIA

--- Ypsilon ---

09/03 -> *

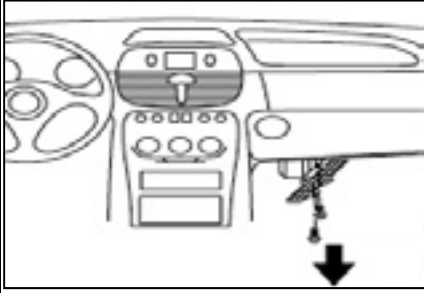

- I** Il filtro è posizionato nell'abitacolo dietro il vano portaoggetti
- GB** The filter is located in the passenger compartment behind the glove compartment
- F** Le filtre est situé dans l'habitacle derrière la boîte à gants
- D** Der filter befindet sich im Fahrgastraum hinter dem Handschuhfach
- E** El filtro se encuentra en el habitáculo detrás de la guantera

CK 9408

215 x 162,5 x 25



O/E numbers
Lancia 46723331 / 77362394
Cross References
Fram CF9408 Mann CU2335
Micronair MP078 Purflux AH201
Tecocar E403 Fiaam PC8093

CK 9408/1-C

215 x 162,5 x 25

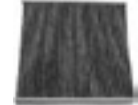

O/E numbers
Lancia 46723331
Cross References
Fram Mann
Micronair Purflux
Tecocar Fiaam

--- Ypsilon II ---

08/10 -> 08/11 *

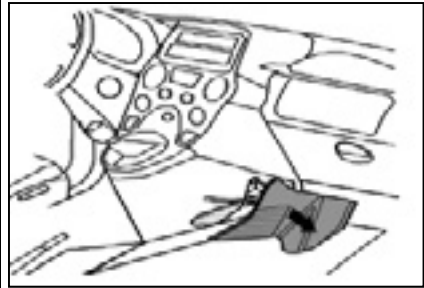

- I** Il filtro è posizionato nell'abitacolo sotto il vano portaoggetti
- GB** The filter is located in the passenger compartment under the glove compartment
- F** Le filtre est situé dans l'habitacle en dessous de la boîte à gants
- D** Der filter befindet sich im Fahrgastraum unter dem Handschuhfach
- E** El filtro se encuentra en el habitáculo, bajo la guantera de pasajerruimte

CK 10025

202 x 176 x 18



O/E numbers
Lancia 46723321
Cross References
Fram CF10025 Mann CU2026
Micronair MP163 Purflux AH233
Tecocar E432 Fiaam PC8159

CK 10025-C

202 x 176 x 18



O/E numbers
Lancia 77365763
Cross References
Fram Mann CUK2026
Micronair MC663 Purflux
Tecocar Fiaam

--- Ypsilon II ---

09/11 -> *

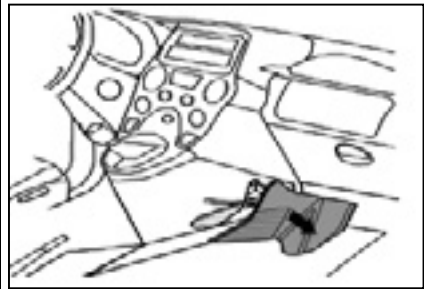

- I** Il filtro è posizionato nell'abitacolo sotto il vano portaoggetti
- GB** The filter is located in the passenger compartment under the glove compartment
- F** Le filtre est situé dans l'habitacle en dessous de la boîte à gants
- D** Der filter befindet sich im Fahrgastraum unter dem Handschuhfach
- E** El filtro se encuentra en el habitáculo, bajo la guantera de pasajerruimte

CK 20006

194 x 188 x 30



O/E numbers
Fiat 51854923
Cross References
Fram CF11470 Mann CU20006
Micronair MP412 Purflux AH371
Tecocar E665 Fiaam PC8340

CK 20006-C

194 x 188 x 30



O/E numbers
Fiat 71775823
Cross References
Fram Mann CUK20006
Micronair Purflux
Tecocar Fiaam

--- Zeta ---

05/95 -> 09/02 *

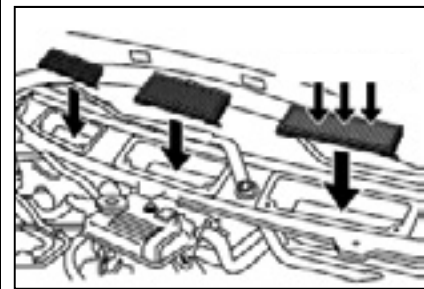

- I** Il filtro è posizionato nel vano motore sul lato passeggero
- GB** The filter is located in the engine compartment on the passenger's side
- F** Le filtre est situé dans le compartiment moteur du côté passager
- D** Der filter befindet sich Motorraum auf der Beifahrerseite
- E** El filtro se encuentra en el compartimiento del motor, del lado del acompañante

CK 8947-3

- 1) 194 x 94/86 x 33
- 2) 194 x 67/64 x 33



O/E numbers
Lancia 1475478080 / 1475479080
Cross References
Fram CF8947/CF8948 Mann CU19000-3
Micronair MP087-3 Purflux AH112/AH113
Tecocar E315/E316 Fiaam PC8055/PC8056



Anti-pollen

Activated carbon

LAND ROVER

--- Discovery 3 / LR3 ---

09/06 ->

*

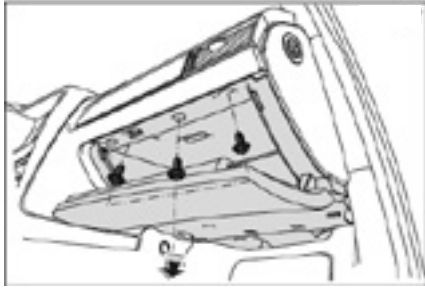

- I** Il filtro è posizionato nell'abitacolo sotto il vano portaoggetti
- GB** The filter is located in the passenger compartment under the glove compartment
- F** Le filtre est situé dans l'habitacle en dessous de la boîte à gants
- D** Der filter befindet sich im Fahrgastraum unter dem Handshuhfach
- E** El filtro se encuentra en el habitáculo, bajo la guanterain de pasajerruimte

CK 2747-C

270 x 160 x 30



O/E numbers

Land Rover JKR500020 / LR023977

Cross References

Fram CFA10417 Mann CUK2747
Micronair MC676 Purflux AHC494
Tecnocar EC474 Fiaam PCK8203

--- Discovery 4 / LR4 ---

09/09 ->

*

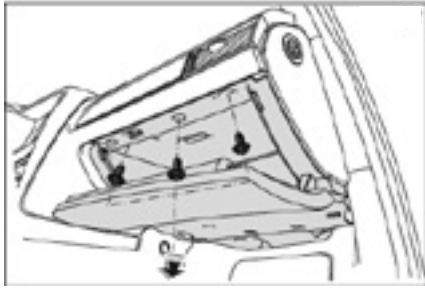

- I** Il filtro è posizionato nell'abitacolo sotto il vano portaoggetti
- GB** The filter is located in the passenger compartment under the glove compartment
- F** Le filtre est situé dans l'habitacle en dessous de la boîte à gants
- D** Der filter befindet sich im Fahrgastraum unter dem Handshuhfach
- E** El filtro se encuentra en el habitáculo, bajo la guanterain de pasajerruimte

CK 2747-C

270 x 160 x 30

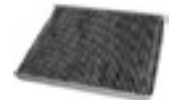

O/E numbers

Land Rover JKR500020 / LR023977

Cross References

Fram CFA10417 Mann CUK2747
Micronair MC676 Purflux AHC494
Tecnocar EC474 Fiaam PCK8203

--- Discovery Sport ---

09/14 ->

*

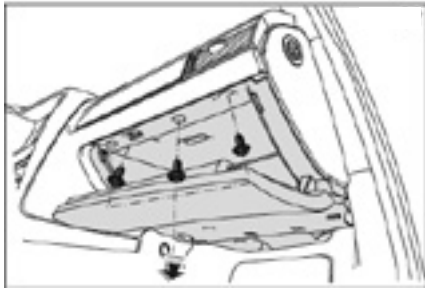

- I** Il filtro è posizionato nell'abitacolo sotto il vano portaoggetti
- GB** The filter is located in the passenger compartment under the glove compartment
- F** Le filtre est situé dans l'habitacle en dessous de la boîte à gants
- D** Der filter befindet sich im Fahrgastraum unter dem Handshuhfach
- E** El filtro se encuentra en el habitáculo, bajo la guanterain de pasajerruimte

CK 2733

287 x 195 x 36



O/E numbers

Land Rover LR000899 / LR019192

Cross References

Fram CF10442 Mann CU2733
Micronair MC808 Purflux AH267
Tecnocar E469 Fiaam PC8197

CK 2733-C

287 x 195 x 36



O/E numbers

Land Rover LR000901 / LR019589

Cross References

Fram CFA10435 Mann CUK2733
Micronair Purflux AHC267
Tecnocar EC469 Fiaam

--- Freelander ---

11/00 ->

*

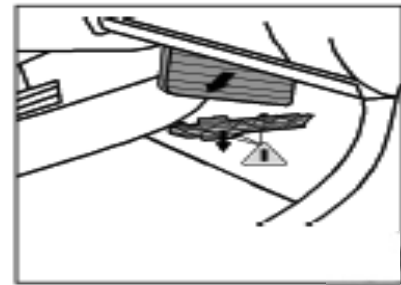

- I** Il filtro è posizionato nell'abitacolo sul lato conducente
- GB** The filter is located in the passenger compartment on the driver's side
- F** Le filtre est situé dans l'habitacle du côté conducteur
- D** Der Filter befindet sich im Fahrgastraum auf der Fahrerseite
- E** El Filtro se encuentra en el habitáculo, del lado del conductor

CK 10087

249 x 204 x 32/73

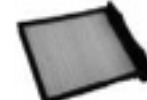

O/E numbers

Land Rover JKR100280

Cross References

Fram CF10087 Mann CU2423
Micronair MP234 Purflux AH222
Tecnocar E450 Fiaam PC8234

--- Freelander II (L359) ---

10/06 ->

*

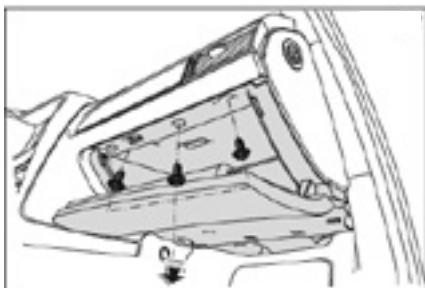

- I** Il filtro è posizionato nell'abitacolo sotto il vano portaoggetti
- GB** The filter is located in the passenger compartment under the glove compartment
- F** Le filtre est situé dans l'habitacle en dessous de la boîte à gants
- D** Der filter befindet sich im Fahrgastraum unter dem Handshuhfach
- E** El filtro se encuentra en el habitáculo, bajo la guanterain de pasajerruimte

CK 2733

287 x 195 x 36



O/E numbers

Land Rover LR000899 / LR019192

Cross References

Fram CF10442 Mann CU2733
Micronair MC808 Purflux AH267
Tecnocar E469 Fiaam PC8197

CK 2733-C

287 x 195 x 36

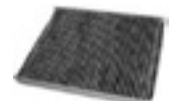

O/E numbers

Land Rover LR000901 / LR019589

Cross References

Fram CFA10435 Mann CUK2733
Micronair Purflux AHC267
Tecnocar EC469 Fiaam



Anti-pollen

Activated carbon

LAND ROVER

--- Range Rover Evoque ---

10/06 -> *

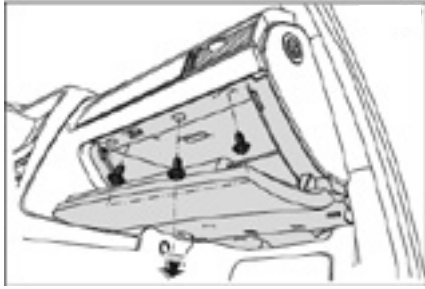

- I** Il filtro è posizionato nell'abitacolo sotto il vano portaoggetti
- GB** The filter is located in the passenger compartment under the glove compartment
- F** Le filtre est situé dans l'habitacle en dessous de la boîte à gants
- D** Der filter befindet sich im Fahrgastraum unter dem Handshuhfach
- E** El filtro se encuentra en el habitáculo, bajo la guantera de pasajerruimte

CK 2733

287 x 195 x 36



O/E numbers

Land Rover LR000899 / LR019192

Cross References

Fram CF10442 Mann CU2733
 Micronair MC808 Purflux AH267
 Tecnocar E469 Fiaam PC8197

CK 2733-C

287 x 195 x 36

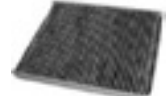

O/E numbers

Land Rover LR000901 / LR019589

Cross References

Fram CFA10435 Mann CUK2733
 Micronair Purflux AHC267
 Tecnocar EC469 Fiaam

--- Range Rover II ---

2 filters are required

07/94 -> 03/02

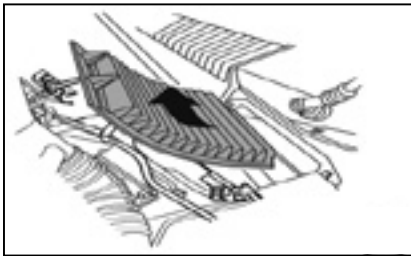

- I** Il filtro è posizionato nel vano motore
- GB** The filter is located in the engine compartment
- F** Le filtre est situé dans le compartiment moteur
- D** Der filter befindet sich Motorraum
- E** El filtro se encuentra en el compartimiento del motor

CK 8719

218 x 195 x 26



O/E numbers

Land Rover BTR8037

Cross References

Fram CF8719 Mann CU1009
 Micronair MP235 Purflux.....
 Tecnocar Fiaam PC8127

--- Range Rover III ---

03/02 -> *

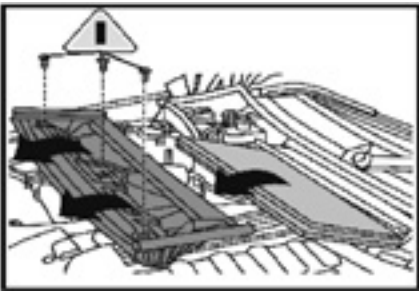

- I** Il filtro è posizionato nel vano motore sul lato passeggero
- GB** The filter is located in the engine compartment on the passenger's side
- F** Le filtre est situé dans le compartiment moteur du côté passager
- D** Der filter befindet sich Motorraum auf der Beifahrerseite
- E** El filtro se encuentra en el compartimiento del motor, del lado del acompañante

CK 5366

540 x 260 x 31,5



O/E numbers

Land Rover.....

Cross References

Fram Mann CU5366
 Micronair MP149 Purflux.....
 Tecnocar..... Fiaam.....

CK 5366-C

540 x 260 x 31,5



O/E numbers

Land Rover JM0000010

Cross References

Fram CFA10830 Mann CUK5366
 Micronair MC649 Purflux AHC299
 Tecnocar EC609 Fiaam PCK8262

--- Range Rover Sport ---

05/05 -> *

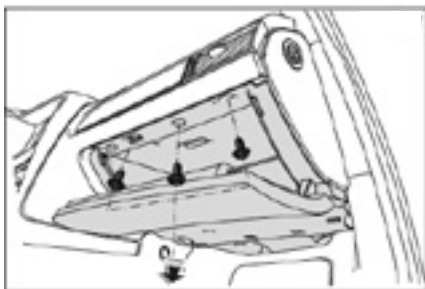

- I** Il filtro è posizionato nell'abitacolo sotto il vano portaoggetti
- GB** The filter is located in the passenger compartment under the glove compartment
- F** Le filtre est situé dans l'habitacle en dessous de la boîte à gants
- D** Der filter befindet sich im Fahrgastraum unter dem Handshuhfach
- E** El filtro se encuentra en el habitáculo, bajo la guantera de pasajerruimte

CK 2747-C

270 x 160 x 30

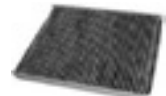

O/E numbers

Land Rover JKR500020 / LR023977

Cross References

Fram CFA10417 Mann CUK2747
 Micronair MC676 Purflux AHC494
 Tecnocar EC474 Fiaam PCK8203



Anno di fabbricazione / Year of construction
 Anné de fabrication / Baujahr / Año de fabricaci6n



Con climatizzatore / With air-conditioning / Avec climatisation
 Mit Klimaanlage / Con instalaci6n de aire acondicionado





Senza climatizzatore / Without air-conditioning / Sans climatisation
 Ohne Klimaanlage / Sin instalaci6n de aire acondicionado





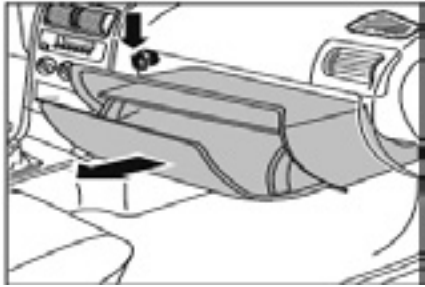

Anti-pollen

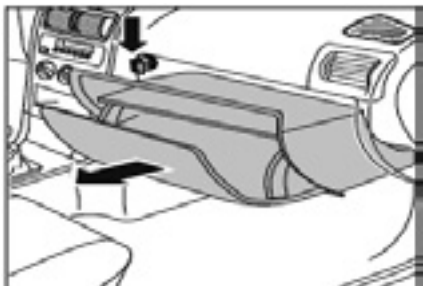

Activated carbon

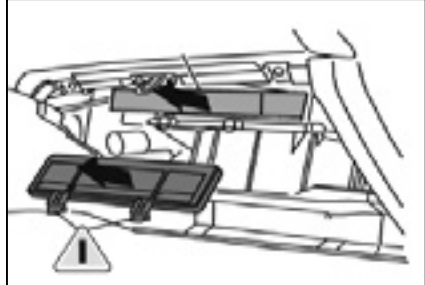

LEXUS

<p>--- CT ---</p>  <p>03/11 -> <input type="checkbox"/> <input type="checkbox"/></p> <p> <input type="radio"/> Il filtro è posizionato nell'abitacolo dietro il vano portaoggetti <input checked="" type="radio"/> The filter is located in the passenger compartment behind the glove compartment <input type="radio"/> Le filtre est situé dans l'habitacle derrière la boîte à gants <input type="radio"/> Der filter befindet sich im Fahrgastraum hinter dem Handschuhfach <input type="radio"/> El filtro se encuentra en el habitáculo detrás de la guantera </p>	<p>CK 1919</p> <p>215 x 193 x 29</p>  <p><u>O/E numbers</u> Lexus..... <u>Cross References</u> Fram CF10285/CF10322 Mann CU1919 Micronair MP273 Purflux AH256 Tecocar E467 Fiaam PC8186</p>	<p>CK 1919-C</p> <p>215 x 193 x 29</p>  <p><u>O/E numbers</u> Lexus..... <u>Cross References</u> Fram Mann CUK1919 Micronair MC773 Purflux Tecocar Fiaam</p>
---	--	--

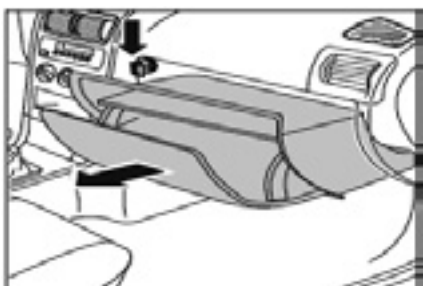
<p>--- GS ---</p>  <p>04/05 -> 12/11 <input type="checkbox"/> <input type="checkbox"/></p> <p> <input type="radio"/> Il filtro è posizionato nell'abitacolo dietro il vano portaoggetti <input checked="" type="radio"/> The filter is located in the passenger compartment behind the glove compartment <input type="radio"/> Le filtre est situé dans l'habitacle derrière la boîte à gants <input type="radio"/> Der filter befindet sich im Fahrgastraum hinter dem Handschuhfach <input type="radio"/> El filtro se encuentra en el habitáculo detrás de la guantera </p>	<p>CK 1919</p> <p>215 x 193 x 29</p>  <p><u>O/E numbers</u> Lexus..... <u>Cross References</u> Fram CF10285/CF10322 Mann CU1919 Micronair MP273 Purflux AH256 Tecocar E467 Fiaam PC8186</p>	<p>CK 1919-C</p> <p>215 x 193 x 29</p>  <p><u>O/E numbers</u> Lexus..... <u>Cross References</u> Fram Mann CUK1919 Micronair MC773 Purflux Tecocar Fiaam</p>
---	--	--

<p>--- GS ---</p>  <p>01/12 -> <input type="checkbox"/> * <input type="checkbox"/> *</p> <p> <input type="radio"/> Il filtro è posizionato nell'abitacolo dietro il vano portaoggetti <input checked="" type="radio"/> The filter is located in the passenger compartment behind the glove compartment <input type="radio"/> Le filtre est situé dans l'habitacle derrière la boîte à gants <input type="radio"/> Der filter befindet sich im Fahrgastraum hinter dem Handschuhfach <input type="radio"/> El filtro se encuentra en el habitáculo detrás de la guantera </p>	<p>CK 9363</p> <p>222 x 200 x 30</p>  <p><u>O/E numbers</u> Lexus..... <u>Cross References</u> Fram CF9363 Mann CU2345 Micronair MP063 Purflux AH204 Tecocar E407 Fiaam PC8083</p>	<p>---</p>
---	---	------------

<p>--- GX ---</p>  <p>01/02 -> 12/08 <input type="checkbox"/> * <input type="checkbox"/> *</p> <p> <input type="radio"/> Il filtro è posizionato nell'abitacolo dietro il vano portaoggetti <input checked="" type="radio"/> The filter is located in the passenger compartment behind the glove compartment <input type="radio"/> Le filtre est situé dans l'habitacle derrière la boîte à gants <input type="radio"/> Der filter befindet sich im Fahrgastraum hinter dem Handschuhfach <input type="radio"/> El filtro se encuentra en el habitáculo detrás de la guantera </p>	<p>CK 1919</p> <p>215 x 193 x 29</p>  <p><u>O/E numbers</u> Lexus..... <u>Cross References</u> Fram CF10285/CF10322 Mann CU1919 Micronair MP273 Purflux AH256 Tecocar E467 Fiaam PC8186</p>	<p>CK 1919-C</p> <p>215 x 193 x 29</p>  <p><u>O/E numbers</u> Lexus..... <u>Cross References</u> Fram Mann CUK1919 Micronair MC773 Purflux Tecocar Fiaam</p>
---	--	--

<p>--- GX ---</p>  <p>01/02 -> 12/08 <input type="checkbox"/> * <input type="checkbox"/> *</p> <p> <input type="radio"/> Il filtro è posizionato nell'abitacolo dietro il vano portaoggetti <input checked="" type="radio"/> The filter is located in the passenger compartment behind the glove compartment <input type="radio"/> Le filtre est situé dans l'habitacle derrière la boîte à gants <input type="radio"/> Der filter befindet sich im Fahrgastraum hinter dem Handschuhfach <input type="radio"/> El filtro se encuentra en el habitáculo detrás de la guantera </p>	<p>CK 9846</p> <p>215 x 215 x 17</p>  <p><u>O/E numbers</u> Lexus..... <u>Cross References</u> Fram CF9846 Mann CU2131 Micronair MP105 Purflux AH210 Tecocar E414 Fiaam PC8144</p>	<p>---</p>
---	---	------------



Anti-pollen

Activated carbon

LEXUS

<p>--- GX ---</p>	<p>01/09 -></p>	<p>*</p>	<p>CK 1919 215 x 193 x 29</p> <p><u>O/E numbers</u> Lexus..... <u>Cross References</u> Fram CF10285/CF10322 Mann CU1919 Micronair MP273 Purflux AH256 Tecocar E467 Fiaam PC8186</p>	<p>CK 1919-C 215 x 193 x 29</p> <p><u>O/E numbers</u> Lexus..... <u>Cross References</u> Fram Mann CUK1919 Micronair MC773 Purflux Tecocar Fiaam</p>
	<p>Il filtro è posizionato nell'abitacolo dietro il vano portaoggetti</p> <p>The filter is located in the passenger compartment behind the glove compartment</p> <p>Le filtre est situé dans l'habitacle derrière la boîte à gants</p> <p>Der filter befindet sich im Fahrgastraum hinter dem Handschuhfach</p> <p>El filtro se encuentra en el habitáculo detrás de la guantera</p>			

<p>--- IS ---</p>	<p>09/05 -></p>	<p>*</p>	<p>CK 1919 215 x 193 x 29</p> <p><u>O/E numbers</u> Lexus..... <u>Cross References</u> Fram CF10285/CF10322 Mann CU1919 Micronair MP273 Purflux AH256 Tecocar E467 Fiaam PC8186</p>	<p>CK 1919-C 215 x 193 x 29</p> <p><u>O/E numbers</u> Lexus..... <u>Cross References</u> Fram Mann CUK1919 Micronair MC773 Purflux Tecocar Fiaam</p>
	<p>Il filtro è posizionato nell'abitacolo dietro il vano portaoggetti</p> <p>The filter is located in the passenger compartment behind the glove compartment</p> <p>Le filtre est situé dans l'habitacle derrière la boîte à gants</p> <p>Der filter befindet sich im Fahrgastraum hinter dem Handschuhfach</p> <p>El filtro se encuentra en el habitáculo detrás de la guantera</p>			

<p>--- IS (XE30) ---</p>	<p>04/13 -></p>	<p>*</p>	<p>CK 9363 222 x 200 x 30</p> <p><u>O/E numbers</u> Lexus..... <u>Cross References</u> Fram CF9363 Mann CU2345 Micronair MP063 Purflux AH204 Tecocar E407 Fiaam PC8083</p>	<p>---</p>
	<p>Il filtro è posizionato nell'abitacolo dietro il vano portaoggetti</p> <p>The filter is located in the passenger compartment behind the glove compartment</p> <p>Le filtre est situé dans l'habitacle derrière la boîte à gants</p> <p>Der filter befindet sich im Fahrgastraum hinter dem Handschuhfach</p> <p>El filtro se encuentra en el habitáculo detrás de la guantera</p>			

<p>--- LS ---</p>	<p>04/06 -></p>	<p>*</p>	<p>CK 1919 215 x 193 x 29</p> <p><u>O/E numbers</u> Lexus..... <u>Cross References</u> Fram CF10285/CF10322 Mann CU1919 Micronair MP273 Purflux AH256 Tecocar E467 Fiaam PC8186</p>	<p>CK 1919-C 215 x 193 x 29</p> <p><u>O/E numbers</u> Lexus..... <u>Cross References</u> Fram Mann CUK1919 Micronair MC773 Purflux Tecocar Fiaam</p>
	<p>Il filtro è posizionato nell'abitacolo dietro il vano portaoggetti</p> <p>The filter is located in the passenger compartment behind the glove compartment</p> <p>Le filtre est situé dans l'habitacle derrière la boîte à gants</p> <p>Der filter befindet sich im Fahrgastraum hinter dem Handschuhfach</p> <p>El filtro se encuentra en el habitáculo detrás de la guantera</p>			









<p>--- NX ---</p>	<p>07/14 -></p>	<p>*</p>	<p>CK 1919 215 x 193 x 29</p> <p><u>O/E numbers</u> Lexus..... <u>Cross References</u> Fram CF10285/CF10322 Mann CU1919 Micronair MP273 Purflux AH256 Tecocar E467 Fiaam PC8186</p>	<p>CK 1919-C 215 x 193 x 29</p> <p><u>O/E numbers</u> Lexus..... <u>Cross References</u> Fram Mann CUK1919 Micronair MC773 Purflux Tecocar Fiaam</p>
	<p>Il filtro è posizionato nell'abitacolo dietro il vano portaoggetti</p> <p>The filter is located in the passenger compartment behind the glove compartment</p> <p>Le filtre est situé dans l'habitacle derrière la boîte à gants</p> <p>Der filter befindet sich im Fahrgastraum hinter dem Handschuhfach</p> <p>El filtro se encuentra en el habitáculo detrás de la guantera</p>			

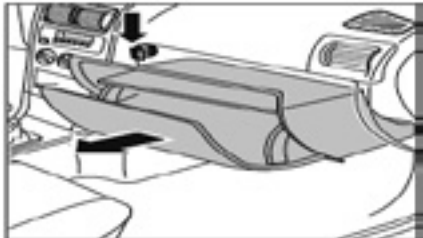

Anti-pollen

Activated carbon

LEXUS

<p>--- RX ---</p>  <ul style="list-style-type: none">  Il filtro è posizionato nell'abitacolo dietro il vano portaoggetti  The filter is located in the passenger compartment behind the glove compartment  Le filtre est situé dans l'habitacle derrière la boîte à gants  Der filter befindet sich im Fahrgastraum hinter dem Handshuhfach  El filtro se encuentra en el habitáculo detrás de la guantera 	<p>02/06 -></p>	<p>*</p>	<p>CK 1919 215 x 193 x 29</p>  <p><u>O/E numbers</u> Lexus..... <u>Cross References</u> Fram CF10285/CF10322 Mann CU1919 Micronair MP273 Purflux AH256 Tecnocar E467 Fiaam PC8186</p>	<p>CK 1919-C 215 x 193 x 29</p>  <p><u>O/E numbers</u> Lexus..... <u>Cross References</u> Fram Mann CUK1919 Micronair MC773 Purflux Tecnocar Fiaam</p>
---	--------------------	----------	---	---

--	--	--	--	--

--	--	--	--	--

--	--	--	--	--

--	--	--	--	--



Anti-pollen

Activated carbon

MASERATI

--- Spyder / Coupé ---

09/01 ->

*

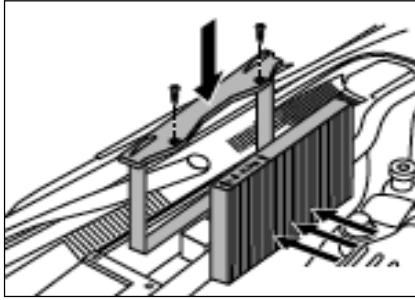

- ① Il filtro è posizionato nel vano motore sul lato passeggero
- Ⓒ The filter is located in the engine compartment on the passenger's side
- Ⓕ Le filtre est situé dans le compartiment moteur du côté passager
- Ⓖ Der filter befindet sich Motorraum auf der Beifahrerseite
- Ⓔ El filtro se encuentra en el compartimiento del motor, del lado del acompañante

CK 5851

293 x 225 x 20



O/E numbers

Maserati

Cross References

Fram CF5851	Mann
Micronair MP016	Purflux AH111
Tecocar E303	Fiaam PC8025

CK 5851-C

293 x 225 x 20



O/E numbers

Maserati 573228900

Cross References

Framm CFA8788	Mann CUK3042
Micronair MC591	Purflux AHC156
Tecocar EC355	Fiaam PCK8036

--- 3200 GT ---

10/98 -> 03/02

*

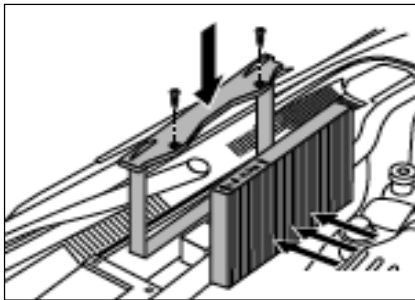

- ① Il filtro è posizionato nel vano motore sul lato passeggero
- Ⓒ The filter is located in the engine compartment on the passenger's side
- Ⓕ Le filtre est situé dans le compartiment moteur du côté passager
- Ⓖ Der filter befindet sich Motorraum auf der Beifahrerseite
- Ⓔ El filtro se encuentra en el compartimiento del motor, del lado del acompañante

CK 5851

293 x 225 x 20



O/E numbers

Maserati

Cross References

Fram CF5851	Mann
Micronair MP016	Purflux AH111
Tecocar E303	Fiaam PC8025

CK 5851-C

293 x 225 x 20



O/E numbers

Maserati 573228900









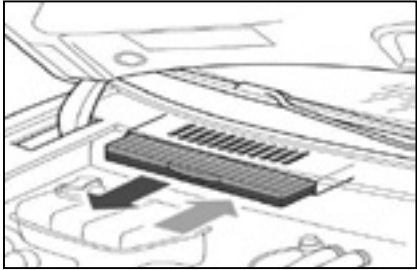

Cross References

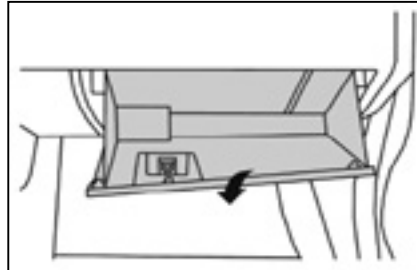
Framm CFA8788	Mann CUK3042
Micronair MC591	Purflux AHC156
Tecocar EC355	Fiaam PCK8036



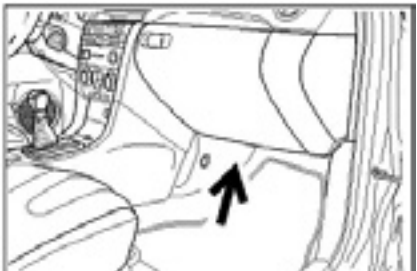

MAZDA



<p>--- 121 ---</p> 	<p>09/01 -> * *</p> <p>I Il filtro è posizionato nel vano motore sul lato passeggero GB The filter is located in the engine compartment on the passenger's side F Le filtre est situé dans le compartiment moteur du côté passager D Der filter befindet sich Motorraum auf der Beifahrerseite E El filtro se encuentra en el compartimiento del motor, del lado del acompañante</p>	<p>CK 5817 354/339 x 161/146 x 29</p>  <p><u>O/E numbers</u> Mazda 410077732 <u>Cross References</u> Fram CF5817 Mann CU3554 Micronair MP017 Purflux AH122 Tecocar E323 Fiaam PC8012</p>	<p>CK 5817-C 354/339 x 161/145 x 29</p>  <p><u>O/E numbers</u> Mazda 410077732 <u>Cross References</u> Fram CFA9623 Mann CUK3554 Micronair MC517 Purflux AHC122 Tecocar EC323 Fiaam PCK8122</p>
<p>--- 2 ---</p> 	<p>03/03 -> 10/07 * </p> <p>I Il filtro è posizionato nell'abitacolo dietro il vano portaoggetti GB The filter is located in the passenger compartment behind the glove compartment F Le filtre est situé dans l'habitacle derrière la boîte à gants D Der filter befindet sich im Fahrgastraum hinter dem Handschuhfach E El filtro se encuentra en el habitáculo detrás de la guantera</p>	<p>CK 9665 216 x 197 x 25</p>  <p><u>O/E numbers</u> Mazda DD1061P11 / GJ6A61P119A <u>Cross References</u> Fram CF10501 Mann CU2043 Micronair MP147/MP172 Purflux AH271 Tecocar E482 Fiaam PC8212</p>	<p>CK 9665-C 216 x 197 x 25</p>  <p><u>O/E numbers</u> Mazda GJ6A61P11 <u>Cross References</u> Fram CFA9665 Mann CUK2043 Micronair MC647 Purflux AHC208 Tecocar EC412 Fiaam PCK8123</p>
<p>--- 3 (BK) ---</p> 	<p>10/03 -> 06/09 * *</p> <p>I Il filtro è posizionato nell'abitacolo dietro il vano portaoggetti GB The filter is located in the passenger compartment behind the glove compartment F Le filtre est situé dans l'habitacle derrière la boîte à gants D Der filter befindet sich im Fahrgastraum hinter dem Handschuhfach E El filtro se encuentra en el habitáculo detrás de la guantera</p>	<p>CK 22001-2 237/217 x 100,5/88 x 16/22</p>  <p><u>O/E numbers</u> Mazda BP4K61J6X / CC2961J6X <u>Cross References</u> Fram CF10218-2 Mann CU22001-2 Micronair MP227-2 Purflux AH251 Tecocar E456-2 Fiaam PC8188-2</p>	<p>---</p>
<p>--- 3 (BL) ---</p> 	<p>06/09 -> * *</p> <p>I Il filtro è posizionato nell'abitacolo dietro il vano portaoggetti GB The filter is located in the passenger compartment behind the glove compartment F Le filtre est situé dans l'habitacle derrière la boîte à gants D Der filter befindet sich im Fahrgastraum hinter dem Handschuhfach E El filtro se encuentra en el habitáculo detrás de la guantera</p>	<p>CK 26008-2 250 x 103 x 17</p>  <p><u>O/E numbers</u> Mazda BBP261J6X / BBP261J6X9A <u>Cross References</u> Fram CF10824-2 Mann CU26008-2 Micronair MP424-2 Purflux AH292 Tecocar E605-2 Fiaam PC8258-2</p>	<p>---</p>
<p>--- 3 (BM) ---</p> 	<p>09/13 -> * *</p> <p>I Il filtro è posizionato nell'abitacolo dietro il vano portaoggetti GB The filter is located in the passenger compartment behind the glove compartment F Le filtre est situé dans l'habitacle derrière la boîte à gants D Der filter befindet sich im Fahrgastraum hinter dem Handschuhfach E El filtro se encuentra en el habitáculo detrás de la guantera</p>	<p>CK 24009 235 x 214 x 28</p>  <p><u>O/E numbers</u> Mazda KD4561J6X <u>Cross References</u> Fram CF11811 Mann CU24009 Micronair Purflux Tecocar E719 Fiaam PC8397</p>	<p>---</p>







Anti-pollen



Activated carbon

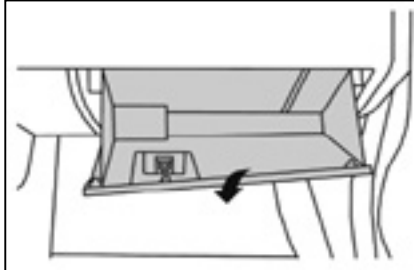

MAZDA

--- 5 ---	06/05 -> 09/10	*	*	<p>CK 22001-2 237/217 x 100,5/88 x 16/22</p>  <p><u>O/E numbers</u> Mazda BP4K61J6X / CC2961J6X</p> <p><u>Cross References</u> Fram CF10218-2 Mann CU22001-2 Micronair MP227-2 Purflux AH251 Tecocar E456-2 Fiaam PC8188-2</p>	---
 <ul style="list-style-type: none"> I Il filtro è posizionato nell'abitacolo dietro il vano portaoggetti GB The filter is located in the passenger compartment behind the glove compartment F Le filtre est situé dans l'habitacle derrière la boîte à gants D Der filter befindet sich im Fahrgastraum hinter dem Handshuhfach E El filtro se encuentra en el habitáculo detrás de la guantera 					

--- 5 II ---	09/10 ->	*	*	<p>CK 22001-2 237/217 x 100,5/88 x 16/22</p>  <p><u>O/E numbers</u> Mazda BP4K61J6X / CC2961J6X</p> <p><u>Cross References</u> Fram CF10218-2 Mann CU22001-2 Micronair MP227-2 Purflux AH251 Tecocar E456-2 Fiaam PC8188-2</p>	---
 <ul style="list-style-type: none"> I Il filtro è posizionato nell'abitacolo dietro il vano portaoggetti GB The filter is located in the passenger compartment behind the glove compartment F Le filtre est situé dans l'habitacle derrière la boîte à gants D Der filter befindet sich im Fahrgastraum hinter dem Handshuhfach E El filtro se encuentra en el habitáculo detrás de la guantera 					

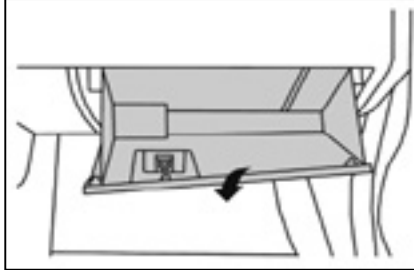
--- 6 (GG/GY) ---	05/02 -> 08/07	*	*	<p>CK 9665 216 x 197 x 25</p>  <p><u>O/E numbers</u> Mazda DD1061P11 / GJ6A61P119A</p> <p><u>Cross References</u> Fram CF10501 Mann CU2043 Micronair MP147/MP172 Purflux AH271 Tecocar E482 Fiaam PC8212</p>	<p>CK 9665-C 216 x 197 x 25</p>  <p><u>O/E numbers</u> Mazda GJ6A61P11</p> <p><u>Cross References</u> Fram CFA9665 Mann CUK2043 Micronair MC647 Purflux AHC208 Tecocar EC412 Fiaam PCK8123</p>
 <ul style="list-style-type: none"> I Il filtro è posizionato nell'abitacolo dietro il vano portaoggetti GB The filter is located in the passenger compartment behind the glove compartment F Le filtre est situé dans l'habitacle derrière la boîte à gants D Der filter befindet sich im Fahrgastraum hinter dem Handshuhfach E El filtro se encuentra en el habitáculo detrás de la guantera 					

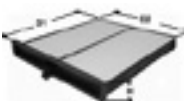
--- 6 (GH) ---	02/08 ->	*	*	<p>CK 9665 216 x 197 x 25</p>  <p><u>O/E numbers</u> Mazda DD1061P11 / GJ6A61P119A</p> <p><u>Cross References</u> Fram CF10501 Mann CU2043 Micronair MP147/MP172 Purflux AH271 Tecocar E482 Fiaam PC8212</p>	<p>CK 9665-C 216 x 197 x 25</p>  <p><u>O/E numbers</u> Mazda GJ6A61P11</p> <p><u>Cross References</u> Fram CFA9665 Mann CUK2043 Micronair MC647 Purflux AHC208 Tecocar EC412 Fiaam PCK8123</p>
 <ul style="list-style-type: none"> I Il filtro è posizionato nell'abitacolo dietro il vano portaoggetti GB The filter is located in the passenger compartment behind the glove compartment F Le filtre est situé dans l'habitacle derrière la boîte à gants D Der filter befindet sich im Fahrgastraum hinter dem Handshuhfach E El filtro se encuentra en el habitáculo detrás de la guantera 					

--- 6 (GJ) ---	02/13 ->	*	*	<p>CK 24009 235 x 214 x 28</p>  <p><u>O/E numbers</u> Mazda KD4561J6X</p> <p><u>Cross References</u> Fram CF11811 Mann CU24009 Micronair Purflux Tecocar E719 Fiaam PC8397</p>	---
 <ul style="list-style-type: none"> I Il filtro è posizionato nell'abitacolo dietro il vano portaoggetti GB The filter is located in the passenger compartment behind the glove compartment F Le filtre est situé dans l'habitacle derrière la boîte à gants D Der filter befindet sich im Fahrgastraum hinter dem Handshuhfach E El filtro se encuentra en el habitáculo detrás de la guantera 					



Anti-pollen

Activated carbon

MAZDA

--- CX-5 ---

04/12 ->

*

*

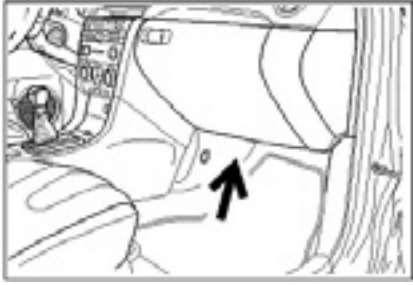

- Il filtro è posizionato nell'abitacolo dietro il vano portaoggetti
- The filter is located in the passenger compartment behind the glove compartment
- Le filtre est situé dans l'habitacle derrière la boîte à gants
- Der filter befindet sich im Fahrgastraum hinter dem Handshuhfach
- El filtro se encuentra en el habitáculo detrás de la guantera

CK 24009

235 x 214 x 28

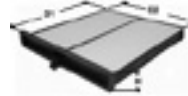

O/E numbers

Mazda KD4561J6X

Cross References

Fram CF11811 Mann CU24009
Micronair Purflux
TecnoCar E719 Fiaam PC8397

--- CX-7 ---

01/07 ->

*

*

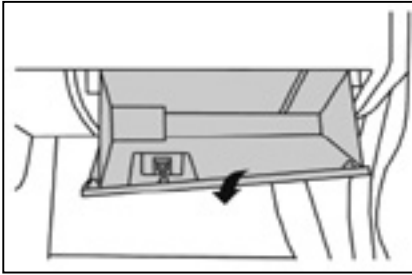

- Il filtro è posizionato nell'abitacolo dietro il vano portaoggetti
- The filter is located in the passenger compartment behind the glove compartment
- Le filtre est situé dans l'habitacle derrière la boîte à gants
- Der filter befindet sich im Fahrgastraum hinter dem Handshuhfach
- El filtro se encuentra en el habitáculo detrás de la guantera

CK 9665

216 x 197 x 25



O/E numbers

Mazda DD1061P11 / GJ6A61P119A

Cross References

Fram CF10501 Mann CU2043
Micronair MP147/MP172 Purflux AH271
TecnoCar E482 Fiaam PC8212

CK 9665-C

216 x 197 x 25



O/E numbers

Mazda GJ6A61P11

Cross References

Fram CFA9665 Mann CUK2043
Micronair MC647 Purflux AHC208
TecnoCar EC412 Fiaam PCK8123



Anti-pollen

Activated carbon

MERCEDES

--- Citan (W415) ---

10/12 ->

*

*

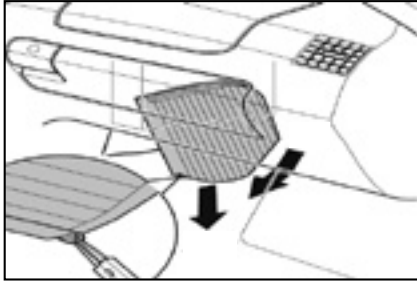

- I** Il filtro è posizionato nel vano motore sul lato passeggero sotto il coperchio della vaschetta del radiatore
- GB** The filter is located in the engine compartment on the passenger's side under the radiator tank cover
- F** Le filtre est situé dans le compartiment moteur du côté passager en dessous du cache du réservoir à eau
- D** Der filter befindet sich Motorraum auf der Beifahrerseite unter der Wasserkastenabdeckung
- E** El filtro se encuentra en el compartimiento del motor, lado del acompañante, bajo la cubierta del depósito del agua

CK 10534-2

239 x 108 x 20



O/E numbers

Mercedes 4158350600 / 4158351100

Cross References

Fram CF10534-2 Mann CU2418-2
 Micronair MP276-2 Purflux AH273-2
 Tecocar E487-2 Fiaam PC8217-2

CK 10534-C-2

239 x 108 x 20

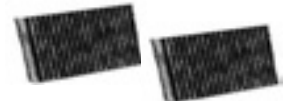

O/E numbers

Mercedes

Cross References

Fram Mann
 Micronair Purflux AHC273
 Tecocar..... Fiaam.....

--- Classe A (W168) ---

09/97 -> 08/04

*

*

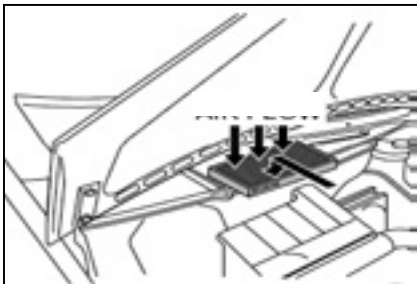

- I** Il filtro è posizionato nel vano motore al centro
- GB** The filter is located in the engine compartment centrally
- F** Le filtre est situé dans le compartiment moteur au centre
- D** Der Filter befindet sich im Motorraum mitting
- E** El filtro se encuentra en el compartimiento del motor, en el centro

CK 8777

364 x 252 x 25



O/E numbers

Mercedes 1688300018

Cross References

Fram CF8777 Mann CU3780
 Micronair MP037 Purflux AH126
 Tecocar E327 Fiaam PC8035

CK 8777-C

364 x 252 x 25



O/E numbers

Mercedes 1688300118 / 1688300818

Cross References

Fram..... Mann CUK3780
 Micronair MC537 Purflux AHC126
 Tecocar..... Fiaam.....

--- Classe A (W169) ---

09/04 ->

*

*

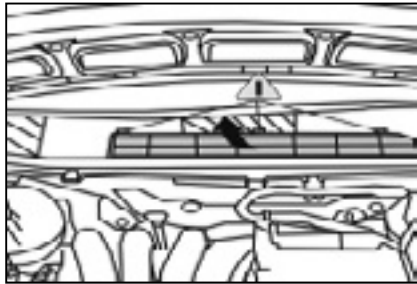

- I** Il filtro è posizionato nel vano motore al centro
- GB** The filter is located in the engine compartment centrally
- F** Le filtre est situé dans le compartiment moteur au centre
- D** Der Filter befindet sich im Motorraum mitting
- E** El filtro se encuentra en el compartimiento del motor, en el centro

CK 10055

394 x 184 x 32



O/E numbers

Mercedes 1698300118

Cross References

Fram..... Mann CU4054
 Micronair MP161 Purflux.....
 Tecocar..... Fiaam.....

CK 10055-C

394 x 184 x 32



O/E numbers

Mercedes 1698300218

Cross References

Fram CFA10055 Mann CUK4054
 Micronair MC661 Purflux AHC237
 Tecocar EC441 Fiaam PCK8162

--- Classe A (W176) ---

09/12 ->

*

*

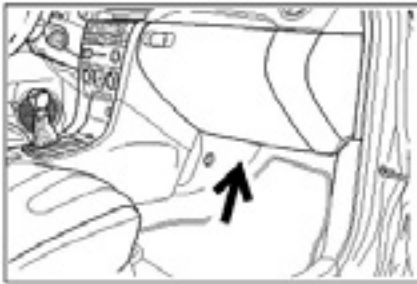

- I** Il filtro è posizionato nell'abitacolo dietro il vano portaoggetti
- GB** The filter is located in the passenger compartment behind the glove compartment
- F** Le filtre est situé dans l'habitacle derrière la boîte à gants
- D** Der filter befindet sich im Fahrgastraum hinter dem Handschuhfach
- E** El filtro se encuentra en el habitáculo detrás de la guantera

CK 879

254,5 x 256 x 214 x 44



O/E numbers

Mercedes

Cross References

Fram Mann
 Micronair Purflux
 Tecocar Fiaam

CK 879-C

254,5 x 256 x 214 x 44



O/E numbers

Mercedes 2468300018

Cross References

Fram CFA11430 Mann CUK26007
 Micronair Purflux AHC402
 Tecocar EC693 Fiaam PCK8371

--- Classe B (W245) ---

04/05 ->

*

*

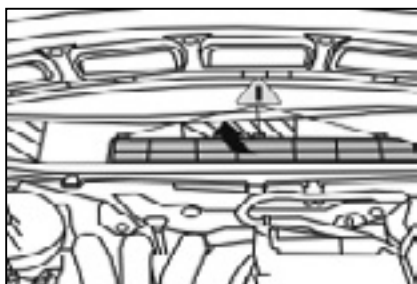

- I** Il filtro è posizionato nel vano motore al centro
- GB** The filter is located in the engine compartment centrally
- F** Le filtre est situé dans le compartiment moteur au centre
- D** Der Filter befindet sich im Motorraum mitting
- E** El filtro se encuentra en el compartimiento del motor, en el centro

CK 10055

394 x 184 x 32



O/E numbers

Mercedes 1698300118

Cross References

Fram..... Mann CU4054
 Micronair MP161 Purflux.....
 Tecocar..... Fiaam.....

CK 10055-C

394 x 184 x 32



O/E numbers

Mercedes 1698300218

Cross References

Fram CFA10055 Mann CUK4054
 Micronair MC661 Purflux AHC237
 Tecocar EC441 Fiaam PCK8162



Anno di fabbricazione / Year of construction
 Anné de fabrication / Baujahr / Año de fabricaciór











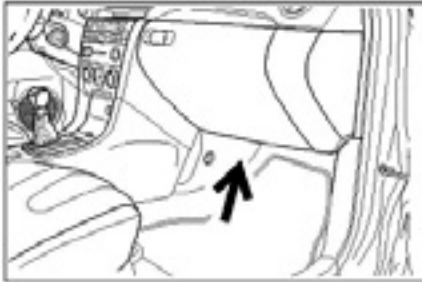

Con climatizzatore / With air-conditioning / Avec climatisation
 Mit Klimaanlage / Con instalación de aire acondicionado

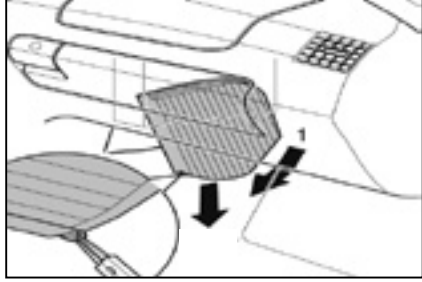

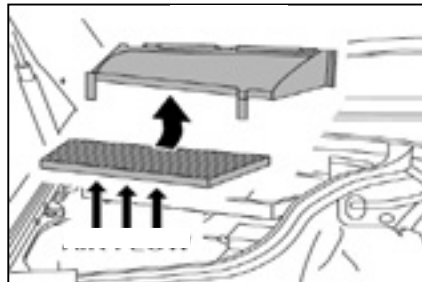
Senza climatizzatore / Without air-conditioning / Sans climatisation
 Ohne Klimaanlage / Sin instalación de aire acondicionado

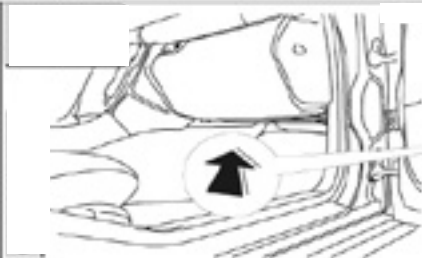

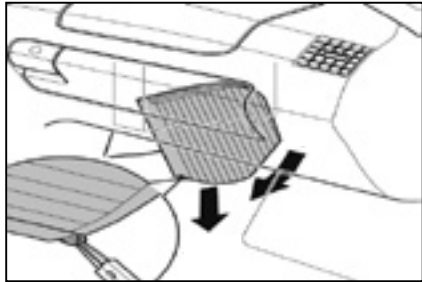
MERCEDES

<p>--- Classe B (W246+W242) ---</p> 	<p>10/11 -> * *</p> <p>I Il filtro è posizionato nell'abitacolo dietro il vano portaoggetti GB The filter is located in the passenger compartment behind the glove compartment F Le filtre est situé dans l'habitacle derrière la boîte à gants D Der filter befindet sich im Fahrgastraum hinter dem Handsuhfach E El filtro se encuentra en el habitáculo detrás de la guantera</p>	<p>CK 879 254,5 x 256 x 214 x 44</p>  <p><u>O/E numbers</u> Mercedes</p> <p><u>Cross References</u> Fram Mann Micronair Purflux Tecocar Fiaam</p>	<p>CK 879-C 254,5 x 256 x 214 x 44</p>  <p><u>O/E numbers</u> Mercedes 2468300018</p> <p><u>Cross References</u> Fram CFA11430 Mann CUK26007 Micronair Purflux AHC402 Tecocar EC693 Fiaam PCK8371</p>
<p>--- Classe C (W202) ---</p> 	<p>03/93 -> 05/00 * *</p> <p>I Il filtro è posizionato nell'abitacolo sotto il vano portaoggetti GB The filter is located in the passenger compartment under the glove compartment F Le filtre est situé dans l'habitacle en dessous de la boîte à gants D Der filter befindet sich im Fahrgastraum unter dem Handsuhfach E El filtro se encuentra en el habitáculo, bajo la guantera in de passagjeriurimte</p>	<p>CK 5842 274/264 x 215/205 x35/53</p>  <p><u>O/E numbers</u> Mercedes 2028300018 / 2028300318</p> <p><u>Cross References</u> Fram CF5842 Mann CU2897 Micronair MP005 Purflux AH138 Tecocar E337 Fiaam PC8016</p>	<p>CK 5842-C 278/262 x 216/206 x 54</p>  <p><u>O/E numbers</u> Mercedes 2108300818 / 2108301218</p> <p><u>Cross References</u> Fram CFA8877 Mann CUK2897 Micronair MC612 Purflux AHC138 Tecocar..... Fiaam PCK8065</p>
<p>--- Classe C (W203) ---</p> 	<p>04/00 -> 06/11 * *</p> <p>I Il filtro è posizionato nel vano motore sul lato passeggero sotto il coperchio della vaschetta del radiatore GB The filter is located in the engine compartment on the passenger's side under the radiator tank cover F Le filtre est situé dans le compartiment moteur du côté passager en dessous du cache du réservoir à eau D Der filter befindet sich Motorraum auf der Beifahrerseite unter der Wasserkastenabdeckung E El filtro se encuentra en el compartimiento del motor, lado del acompañante, bajo la cubierta del depósito del agua</p>	<p>CK 9905 331 x 189 x 25</p>  <p><u>O/E numbers</u> Mercedes 2038300118 / A2038300118</p> <p><u>Cross References</u> Fram CF9905 Mann CU3461 Micronair MP059 Purflux AH194 Tecocar E397 Fiaam PC8147</p>	<p>CK 9905-C 331 x 189 x 25</p>  <p><u>O/E numbers</u> Mercedes 208300918 / A2038300918</p> <p><u>Cross References</u> Fram Mann CUK3461 Micronair MC559 Purflux..... Tecocar..... Fiaam.....</p>
<p>--- Classe C (W203) --- with automatic THERMOTRONIC air conditioning (additionally)</p> 	<p>04/00 -> 06/11 * *</p> <p>I Il filtro è posizionato nell'abitacolo sotto il vano portaoggetti GB The filter is located in the passenger compartment under the glove compartment F Le filtre est situé dans l'habitacle en dessous de la boîte à gants D Der filter befindet sich im Fahrgastraum unter dem Handsuhfach E El filtro se encuentra en el habitáculo, bajo la guantera in de passagjeriurimte</p>	<p>---</p>	<p>CK 9825-C-2 1) 195/185 x 179/169 x 39,5 1) 193,5/183,5 x 145/135 x 39,5</p>  <p><u>O/E numbers</u> Mercedes 2038300318 / 2038300518</p> <p><u>Cross References</u> Fram CFA9825-2 Mann CUK20000-2 Micronair..... Purflux AHC294 Tecocar..... Fiaam.....</p>
<p>--- Classe C (W204/C204/S204) ---</p> 	<p>08/07 -> * *</p> <p>I Il filtro è posizionato nell'abitacolo sotto il vano portaoggetti GB The filter is located in the passenger compartment under the glove compartment F Le filtre est situé dans l'habitacle en dessous de la boîte à gants D Der filter befindet sich im Fahrgastraum unter dem Handsuhfach E El filtro se encuentra en el habitáculo, bajo la guantera in de passagjeriurimte</p>	<p>---</p>	<p>CK 29005-C 262 x 283 x 76</p>  <p><u>O/E numbers</u> Mercedes 2048300018 / 2048300518</p> <p><u>Cross References</u> Fram CFA10934 Mann CUK29005 Micronair Purflux AHC318 Tecocar EC620 Fiaam PCK8278</p>



Anti-pollen

Activated carbon

MERCEDES

--- Classe C (W205/C205/S205) ---

03/14 ->

*

*

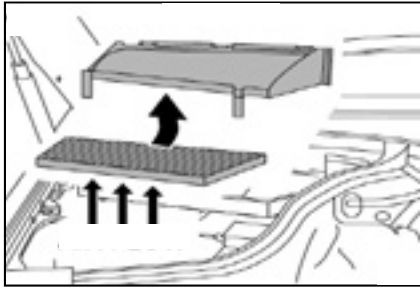

- I** Il filtro è posizionato nel vano motore sul lato passeggero sotto il coperchio della vaschetta del radiatore
- GB** The filter is located in the engine compartment on the passenger's side under the radiator tank cover
- F** Le filtre est situé dans le compartiment moteur du côté passager en dessous du cache du réservoir à eau
- D** Der filter befindet sich Motorraum auf der Beifahrerseite unter der Wasserkastenabdeckung
- E** El filtro se encuentra en el compartimiento del motor, lado del acompañante, bajo la cubierta del depósito del agua

CK 25002

247 x 190 x 32

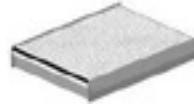

O/E numbers

Mercedes 1668300018 / 1668300218

Cross References

Fram CF11719 Mann CU25002
Micronair Purflux AH409
TecnoCar E700 Fiaam PC8379

CK 25002-C

247 x 190 x 32



O/E numbers

Mercedes

Cross References

Fram Mann
Micronair Purflux.....
TecnoCar..... Fiaam.....

--- Classe CL (C215) ---

09/99 -> 09/06

*

*

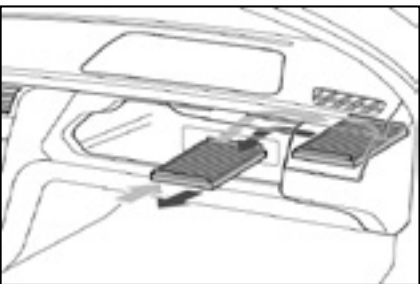

- I** Il filtro è posizionato nell'abitacolo sotto il vano portaoggetti
- GB** The filter is located in the passenger compartment under the glove compartment
- F** Le filtre est situé dans l'habitacle en dessous de la boîte à gants
- D** Der filter befindet sich im Fahrgastraum unter dem Handschuhfach
- E** El filtro se encuentra en el habitáculo, bajo la guanterain de pasajerruimte

CK 5972-2

260/250 x 125/115 x 40

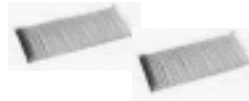

O/E numbers

Mercedes 2108300018 / 2108301018

Cross References

Fram CF5972 Mann CU2745-2
Micronair MP022-2 Purflux AH137
TecnoCar E336 Fiaam PC8033

--- Classe CLA (C117/X117) ---

03/13 ->

*

*

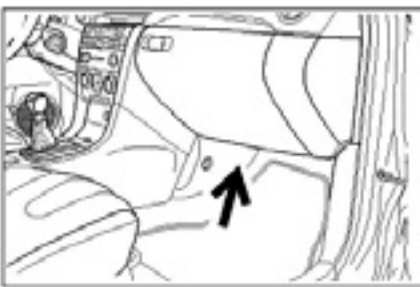

- I** Il filtro è posizionato nell'abitacolo dietro il vano portaoggetti
- GB** The filter is located in the passenger compartment behind the glove compartment
- F** Le filtre est situé dans l'habitacle derrière la boîte à gants
- D** Der filter befindet sich im Fahrgastraum hinter dem Handschuhfach
- E** El filtro se encuentra en el habitáculo detrás de la guantera

CK 879

254,5 x 256 x 214 x 44



O/E numbers

Mercedes

Cross References

Fram Mann
Micronair Purflux
TecnoCar Fiaam

CK 879-C

254,5 x 256 x 214 x 44



O/E numbers

Mercedes 2468300018

Cross References

Fram CFA11430 Mann CUK26007
Micronair Purflux AHC402
TecnoCar EC693 Fiaam PCK8371

--- Classe CLC (C203) ---

05/08 ->

*

*

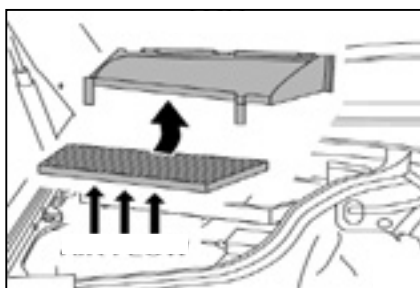

- I** Il filtro è posizionato nel vano motore sul lato passeggero sotto il coperchio della vaschetta del radiatore
- GB** The filter is located in the engine compartment on the passenger's side under the radiator tank cover
- F** Le filtre est situé dans le compartiment moteur du côté passager en dessous du cache du réservoir à eau
- D** Der filter befindet sich Motorraum auf der Beifahrerseite unter der Wasserkastenabdeckung
- E** El filtro se encuentra en el compartimiento del motor, lado del acompañante, bajo la cubierta del depósito del agua

CK 9905

331 x 189 x 25



O/E numbers

Mercedes 2038300118 / A2038300118

Cross References

Fram CF9905 Mann CU3461
Micronair MP059 Purflux AH194
TecnoCar E397 Fiaam PC8147

CK 9905-C

331 x 189 x 25



O/E numbers

Mercedes 208300918 / A2038300918

Cross References

Fram Mann CUK3461
Micronair MC559 Purflux.....
TecnoCar..... Fiaam.....

--- Classe CLC (C203) ---

05/08 ->

*

*

with automatic THERMOTRONIC air conditioning (additionally)

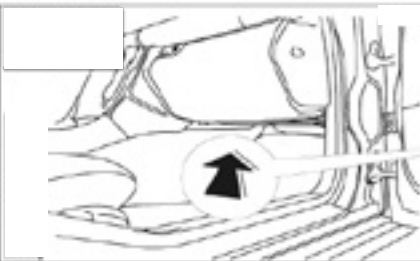

- I** Il filtro è posizionato nell'abitacolo sotto il vano portaoggetti
- GB** The filter is located in the passenger compartment under the glove compartment
- F** Le filtre est situé dans l'habitacle en dessous de la boîte à gants
- D** Der filter befindet sich im Fahrgastraum unter dem Handschuhfach
- E** El filtro se encuentra en el habitáculo, bajo la guanterain de pasajerruimte

CK 9825-C-2

1) 195/185 x 179/169 x 39,5
1) 193,5/183,5 x 145/135 x 39,5



O/E numbers

Mercedes 2038300318 / 2038300518

Cross References

Fram CFA9825-2 Mann CUK20000-2
Micronair..... Purflux AHC294
TecnoCar..... Fiaam.....



Anno di fabbricazione / Year of construction
Anné de fabrication / Baujahr / Año de fabricación



Con climatizzatore / With air-conditioning / Avec climatisation
Mit Klimaanlage / Con instalación de aire acondicionado





Senza climatizzatore / Without air-conditioning / Sans climatisation
Ohne Klimaanlage / Sin instalación de aire acondicionado





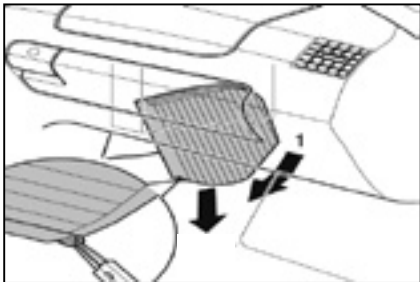

Anti-pollen

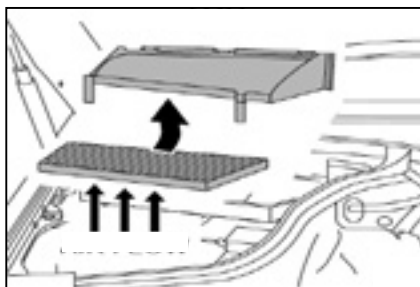

Activated carbon

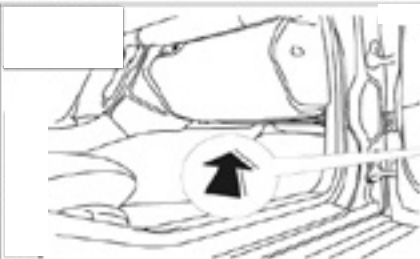

MERCEDES

<p>--- Classe CLK (C208) ---</p>  <p> I Il filtro è posizionato nell'abitacolo sotto il vano portaoggetti GB The filter is located in the passenger compartment under the glove compartment F Le filtre est situé dans l'habitacle en dessous de la boîte à gants D Der filter befindet sich im Fahrgastraum unter dem Handschuhfach E El filtro se encuentra en el habitáculo, bajo la guanterain de pasajgeriurimte </p>	<p>03/93 -> 05/00</p> <p style="text-align: center;">* * □ □</p>	<p>CK 5842 274/264 x 215/205 x35/53</p>  <p><u>O/E numbers</u> Mercedes 2028300018 / 2028300318</p> <p><u>Cross References</u> Fram CF5842 Mann CU2897 Micronair MP005 Purflux AH138 Tecocar E337 Fiaam PC8016</p>	<p>CK 5842-C 278/262 x 216/206 x 54</p>  <p><u>O/E numbers</u> Mercedes 2108300818 / 2108301218</p> <p><u>Cross References</u> Fram CFA8877 Mann CUK2897 Micronair MC612 Purflux AHC138 Tecocar..... Fiaam PCK8065</p>
--	---	--	---

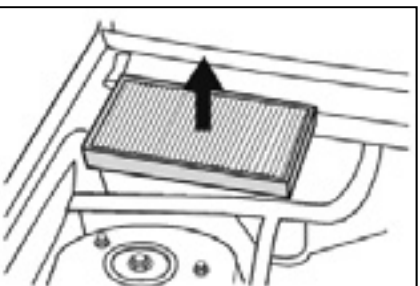
<p>--- Classe CLK (A/C209) ---</p>  <p> I Il filtro è posizionato nel vano motore sul lato passeggero sotto il coperchio della vaschetta del radiatore GB The filter is located in the engine compartment on the passenger's side under the radiator tank cover F Le filtre est situé dans le compartiment moteur du côté passager en dessous du cache du réservoir à eau D Der filter befindet sich Motorraum auf der Beifahrerseite unter der Wasserkastenabdeckung E El filtro se encuentra en el compartimiento del motor, lado del acompañante, bajo la cubierta del depósito del agua </p>	<p>05/02 -> 10/09</p> <p style="text-align: center;">* * □ □</p>	<p>CK 9905 331 x 189 x 25</p>  <p><u>O/E numbers</u> Mercedes 2038300118 / A2038300118</p> <p><u>Cross References</u> Fram CF9905 Mann CU3461 Micronair MP059 Purflux AH194 Tecocar E397 Fiaam PC8147</p>	<p>CK 9905-C 331 x 189 x 25</p>  <p><u>O/E numbers</u> Mercedes 208300918 / A2038300918</p> <p><u>Cross References</u> Fram Mann CUK3461 Micronair MC559 Purflux..... Tecocar..... Fiaam.....</p>
--	---	---	--

<p>--- Classe CLK (A/C209) --- with automatic THERMOTRONIC air conditioning (additionally)</p>  <p> I Il filtro è posizionato nell'abitacolo sotto il vano portaoggetti GB The filter is located in the passenger compartment under the glove compartment F Le filtre est situé dans l'habitacle en dessous de la boîte à gants D Der filter befindet sich im Fahrgastraum unter dem Handschuhfach E El filtro se encuentra en el habitáculo, bajo la guanterain de pasajgeriurimte </p>	<p>05/02 -> 10/09</p> <p style="text-align: center;">* * □ □</p>	<p style="text-align: center;">---</p>	<p>CK 9825-C-2</p> <p>1) 195/185 x 179/169 x 39,5 1) 193,5/183,5 x 145/135 x 39,5</p>  <p><u>O/E numbers</u> Mercedes 2038300318 / 2038300518</p> <p><u>Cross References</u> Fram CFA9825-2 Mann CUK20000-2 Micronair..... Purflux AHC294 Tecocar..... Fiaam.....</p>
--	---	--	--

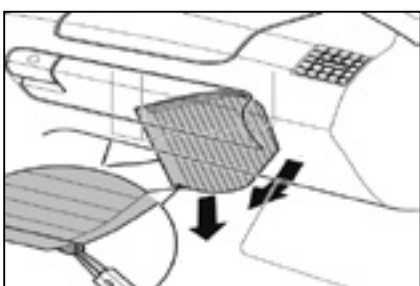
<p>--- Classe CLS (C219) ---</p>  <p> I Il filtro è posizionato nel vano motore sul lato passeggero GB The filter is located in the engine compartment on the passenger's side F Le filtre est situé dans le compartiment moteur du côté passager D Der filter befindet sich Motorraum auf der Beifahrerseite E El filtro se encuentra en el compartimiento del motor, del lado del acompañante </p>	<p>10/04 -> 12/10</p> <p style="text-align: center;">* * □ □</p>	<p>CK 9785 310 x 255 x 34</p>  <p><u>O/E numbers</u> Mercedes 2118300218</p> <p><u>Cross References</u> Fram..... Mann CU3172 Micronair MP109 Purflux Tecocar Fiaam</p>	<p>CK 9785-C 310 x 255 x 34</p>  <p><u>O/E numbers</u> Mercedes 2118300018</p> <p><u>Cross References</u> Fram CFA9785 Mann CUK3172 Micronair MC609 Purflux AHC211 Tecocar EC415 Fiaam PCK8137</p>
--	---	---	---

<p>--- Classe CLS (C218+X218) ---</p>  <p> I Il filtro è posizionato nell'abitacolo sotto il vano portaoggetti GB The filter is located in the passenger compartment under the glove compartment F Le filtre est situé dans l'habitacle en dessous de la boîte à gants D Der filter befindet sich im Fahrgastraum unter dem Handschuhfach E El filtro se encuentra en el habitáculo, bajo la guanterain de pasajgeriurimte </p>	<p>12/10 -></p> <p style="text-align: center;">* □ □ □</p>	<p style="text-align: center;">---</p>	<p>CK 29005-C 262 x 283 x 76</p>  <p><u>O/E numbers</u> Mercedes 2048300018 / 2048300518</p> <p><u>Cross References</u> Fram CFA10934 Mann CUK29005 Micronair Purflux AHC318 Tecocar EC620 Fiaam PCK8278</p>
---	---	--	---



Anti-pollen

Activated carbon

MERCEDES

--- Classe E (W210) ---

06/95 -> 03/02

*

*

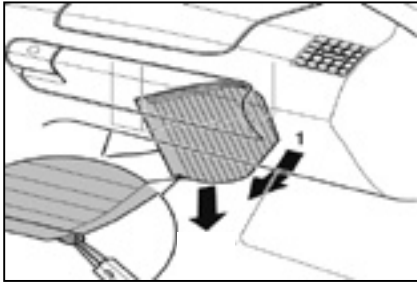

- I** Il filtro è posizionato nell'abitacolo sotto il vano portaoggetti
- GB** The filter is located in the passenger compartment under the glove compartment
- F** Le filtre est situé dans l'habitacle en dessous de la boîte à gants
- D** Der filter befindet sich im Fahrgastraum unter dem Handsuhfach
- E** El filtro se encuentra en el habitáculo, bajo la guantera de pasajerruimte

CK 5842

274/264 x 215/205 x35/53



O/E numbers

Mercedes 2028300018 / 2028300318

Cross References

Fram CF5842 Mann CU2897
 Micronair MP005 Purflux AH138
 Tecnocar E337 Fiaam PC8016

CK 5842-C

278/262 x 216/206 x 54



O/E numbers

Mercedes 2108300018 / 2108301218

Cross References

Fram CFA8877 Mann CUK2897
 Micronair MC612 Purflux AHC138
 Tecnocar..... Fiaam PCK8065

--- Classe E (W210) ---

06/95 -> 03/02

*

*

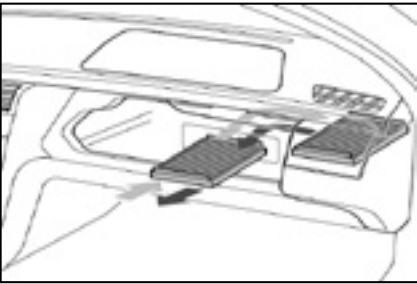

- I** Il filtro è posizionato nell'abitacolo sotto il vano portaoggetti
- GB** The filter is located in the passenger compartment under the glove compartment
- F** Le filtre est situé dans l'habitacle en dessous de la boîte à gants
- D** Der filter befindet sich im Fahrgastraum unter dem Handsuhfach
- E** El filtro se encuentra en el habitáculo, bajo la guantera de pasajerruimte

CK 5972-2

260/250 x 125/115 x 40

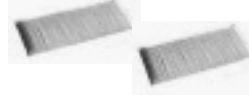

O/E numbers

Mercedes 2108300018 / 2108301018

Cross References

Fram CF5972 Mann CU2745-2
 Micronair MP022-2 Purflux AH137
 Tecnocar E336 Fiaam PC8033

--- Classe E (W/S211) ---

03/02 -> 12/09

*

*

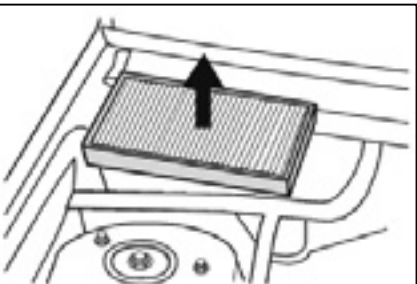

- I** Il filtro è posizionato nel vano motore sul lato passeggero
- GB** The filter is located in the engine compartment on the passenger's side
- F** Le filtre est situé dans le compartiment moteur du côté passager
- D** Der filter befindet sich Motorraum auf der Beifahrerseite
- E** El filtro se encuentra en el compartimiento del motor, del lado del acompañante

CK 9785

310 x 255 x 34



O/E numbers

Mercedes 2118300218

Cross References

Fram..... Mann CU3172
 Micronair MP109 Purflux

CK 9785-C

310 x 255 x 34



O/E numbers

Mercedes 2118300018

Cross References

Fram CFA9785 Mann CUK3172
 Micronair MC609 Purflux AHC211
 Tecnocar EC415 Fiaam PCK8137

--- Classe E (W/S212) ---

03/09 ->

*

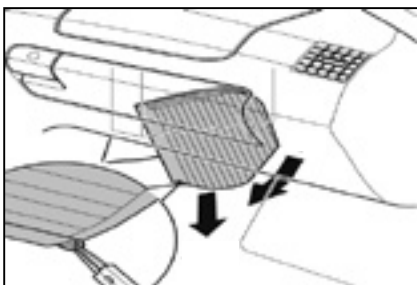

- I** Il filtro è posizionato nell'abitacolo sotto il vano portaoggetti
- GB** The filter is located in the passenger compartment under the glove compartment
- F** Le filtre est situé dans l'habitacle en dessous de la boîte à gants
- D** Der filter befindet sich im Fahrgastraum unter dem Handsuhfach
- E** El filtro se encuentra en el habitáculo, bajo la guantera de pasajerruimte

CK 29005-C

262 x 283 x 76



O/E numbers

Mercedes 2048300018 / 2048300518

Cross References

Fram CFA10934 Mann CUK29005
 Micronair Purflux AHC318
 Tecnocar EC620 Fiaam PCK8278

--- Classe E Coupé/Cabriolet (A/C207) ---

05/09 ->

*

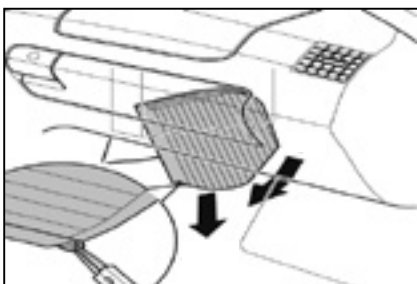

- I** Il filtro è posizionato nell'abitacolo sotto il vano portaoggetti
- GB** The filter is located in the passenger compartment under the glove compartment
- F** Le filtre est situé dans l'habitacle en dessous de la boîte à gants
- D** Der filter befindet sich im Fahrgastraum unter dem Handsuhfach
- E** El filtro se encuentra en el habitáculo, bajo la guantera de pasajerruimte

CK 29005-C

262 x 283 x 76



O/E numbers

Mercedes 2048300018 / 2048300518

Cross References



Fram CFA10934 Mann CUK29005
 Micronair Purflux AHC318
 Tecnocar EC620 Fiaam PCK8278





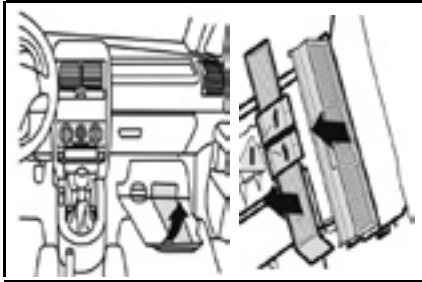

Anti-pollen

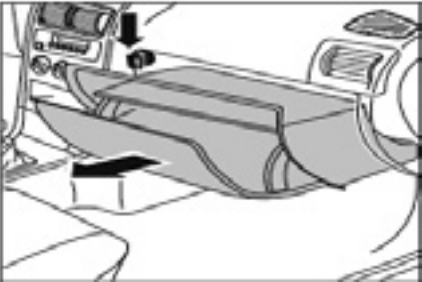

Activated carbon

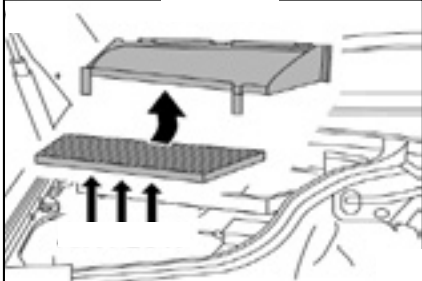
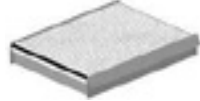

MERCEDES

<p>--- Classe G (W461/W463) ---</p> 	09/00 ->	*	*	<p>CK 9323 251 x 215 x 32</p>  <p><u>O/E numbers</u> Mercedes.....</p> <p><u>Cross References</u> Fram CF9323 Mann CU2545 Micronair MP060 Purflux AH191 Tecocar E394 Fiaam PC8077</p>	<p>CK 9323-C 251 x 215 x 32</p>  <p><u>O/E numbers</u> Mercedes 4638300018</p> <p><u>Cross References</u> Fram CFA9404 Mann CUK2545 Micronair MC560 Purflux AHC191 Tecocar EC394 Fiaam PCK8092</p>
	<p>I Il filtro è posizionato nell'abitacolo dietro il vano portaoggetti</p> <p>GB The filter is located in the passenger compartment behind the glove compartment</p> <p>F Le filtre est situé dans l'habitacle derrière la boîte à gants</p> <p>D Der filter befindet sich im Fahrgastraum hinter dem Handshuhfach</p> <p>E El filtro se encuentra en el habitáculo detrás de la guantera</p>				

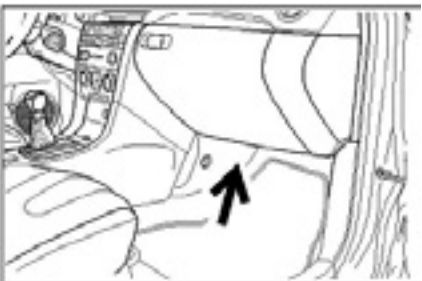
<p>--- Classe GL (X164) ---</p> 	03/06 ->	*	*	<p>---</p>	<p>CK 2646-C-2 254 x 134 x 40</p>  <p><u>O/E numbers</u> Mercedes 1648300218</p> <p><u>Cross References</u> Fram CFA10828-2 Mann CUK2646-2 Micronair MC738-2 Purflux AHC241 Tecocar..... Fiaam PCK8260-2</p>
	<p>I Il filtro è posizionato nell'abitacolo dietro il vano portaoggetti</p> <p>GB The filter is located in the passenger compartment behind the glove compartment</p> <p>F Le filtre est situé dans l'habitacle derrière la boîte à gants</p> <p>D Der filter befindet sich im Fahrgastraum hinter dem Handshuhfach</p> <p>E El filtro se encuentra en el habitáculo detrás de la guantera</p>				

<p>--- Classe GL / GLS (X166) ---</p> 	08/12 ->	*	*	<p>CK 25002 247 x 190 x 32</p>  <p><u>O/E numbers</u> Mercedes 1668300018 / 1668300218</p> <p><u>Cross References</u> Fram CF11719 Mann CU25002 Micronair Purflux AH409 Tecocar E700 Fiaam PC8379</p>	<p>CK 25002-C 247 x 190 x 32</p>  <p><u>O/E numbers</u> Mercedes</p> <p><u>Cross References</u> Fram Mann Micronair Purflux..... Tecocar..... Fiaam.....</p>
	<p>I Il filtro è posizionato nel vano motore sul lato passeggero sotto il coperchio della vaschetta del radiatore</p> <p>GB The filter is located in the engine compartment on the passenger's side under the radiator tank cover</p> <p>F Le filtre est situé dans le compartiment moteur du côté passager en dessous du cache du réservoir à eau</p> <p>D Der filter befindet sich Motorraum auf der Beifahrerseite unter der Wasserkastenabdeckung</p> <p>E El filtro se encuentra en el compartimiento del motor, lado del acompañante, bajo la cubierta del depósito del agua</p>				

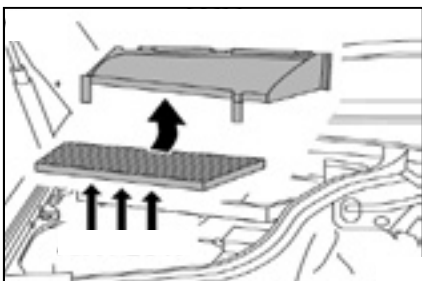
<p>--- Classe GLA (X156) ---</p> 	09/13 ->	*	*	<p>CK 879 254,5 x 256 x 214 x 44</p>  <p><u>O/E numbers</u> Mercedes</p> <p><u>Cross References</u> Fram Mann Micronair Purflux..... Tecocar Fiaam.....</p>	<p>CK 879-C 254,5 x 256 x 214 x 44</p>  <p><u>O/E numbers</u> Mercedes 2468300018</p> <p><u>Cross References</u> Fram CFA11430 Mann CUK26007 Micronair Purflux AHC402 Tecocar EC693 Fiaam PCK8371</p>
	<p>I Il filtro è posizionato nell'abitacolo dietro il vano portaoggetti</p> <p>GB The filter is located in the passenger compartment behind the glove compartment</p> <p>F Le filtre est situé dans l'habitacle derrière la boîte à gants</p> <p>D Der filter befindet sich im Fahrgastraum hinter dem Handshuhfach</p> <p>E El filtro se encuentra en el habitáculo detrás de la guantera</p>				

<p>--- Classe GLC (X253) ---</p> 	08/15 ->	*	*	<p>CK 25002 247 x 190 x 32</p>  <p><u>O/E numbers</u> Mercedes 1668300018 / 1668300218</p> <p><u>Cross References</u> Fram CF11719 Mann CU25002 Micronair Purflux AH409 Tecocar E700 Fiaam PC8379</p>	<p>CK 25002-C 247 x 190 x 32</p>  <p><u>O/E numbers</u> Mercedes</p> <p><u>Cross References</u> Fram Mann Micronair Purflux..... Tecocar..... Fiaam.....</p>
	<p>I Il filtro è posizionato nel vano motore sul lato passeggero sotto il coperchio della vaschetta del radiatore</p> <p>GB The filter is located in the engine compartment on the passenger's side under the radiator tank cover</p> <p>F Le filtre est situé dans le compartiment moteur du côté passager en dessous du cache du réservoir à eau</p> <p>D Der filter befindet sich Motorraum auf der Beifahrerseite unter der Wasserkastenabdeckung</p> <p>E El filtro se encuentra en el compartimiento del motor, lado del acompañante, bajo la cubierta del depósito del agua</p>				



Anti-pollen

Activated carbon

--- Classe GLE (W166) ---

04/15 ->

*

*

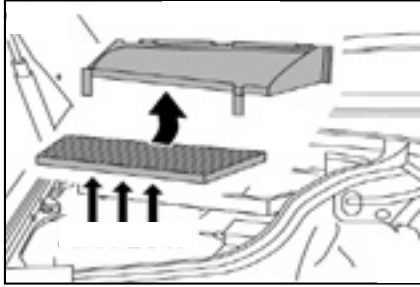

- I** Il filtro è posizionato nel vano motore sul lato passeggero sotto il coperchio della vaschetta del radiatore
- GB** The filter is located in the engine compartment on the passenger's side under the radiator tank cover
- F** Le filtre est situé dans le compartiment moteur du côté passager en dessous du cache du réservoir à eau
- D** Der filter befindet sich Motorraum auf der Beifahrerseite unter der Wasserkastenabdeckung
- E** El filtro se encuentra en el compartimiento del motor, lado del acompañante, bajo la cubierta del depósito del agua

CK 25002

247 x 190 x 32



O/E numbers

Mercedes 1668300018 / 1668300218

Cross References

Fram CF11719 Mann CU25002
Micronair Purflux AH409
Tecocar E700 Fiaam PC8379

CK 25002-C

247 x 190 x 32



O/E numbers

Mercedes

Cross References

Fram Mann
Micronair Purflux.....
Tecocar..... Fiaam.....

--- Classe GLE Coupé (C292) ---

06/15 ->

*

*

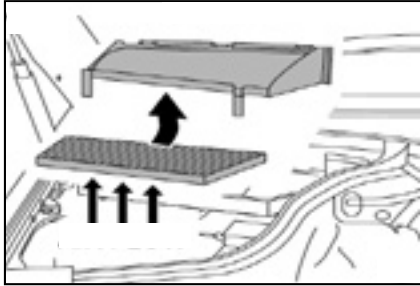

- I** Il filtro è posizionato nel vano motore sul lato passeggero sotto il coperchio della vaschetta del radiatore
- GB** The filter is located in the engine compartment on the passenger's side under the radiator tank cover
- F** Le filtre est situé dans le compartiment moteur du côté passager en dessous du cache du réservoir à eau
- D** Der filter befindet sich Motorraum auf der Beifahrerseite unter der Wasserkastenabdeckung
- E** El filtro se encuentra en el compartimiento del motor, lado del acompañante, bajo la cubierta del depósito del agua

CK 25002

247 x 190 x 32

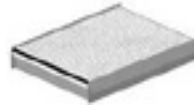

O/E numbers

Mercedes 1668300018 / 1668300218

Cross References

Fram CF11719 Mann CU25002
Micronair Purflux AH409
Tecocar E700 Fiaam PC8379

CK 25002-C

247 x 190 x 32



O/E numbers

Mercedes

Cross References

Fram Mann
Micronair Purflux.....
Tecocar..... Fiaam.....

--- Classe GLK (X204) ---

06/08 ->

*

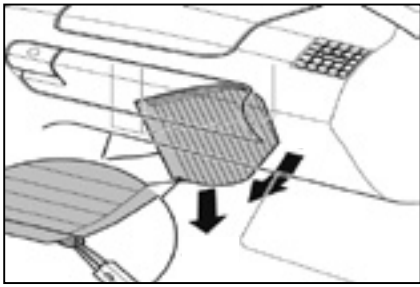

- I** Il filtro è posizionato nell'abitacolo sotto il vano portaoggetti
- GB** The filter is located in the passenger compartment under the glove compartment
- F** Le filtre est situé dans l'habitacle en dessous de la boîte à gants
- D** Der filter befindet sich im Fahrgastraum unter dem Handsuhfach
- E** El filtro se encuentra en el habitáculo, bajo la guanterain de pasajerruimte

CK 29005-C

262 x 283 x 76



O/E numbers

Mercedes 2048300018 / 2048300518

Cross References

Fram CFA10934 Mann CUK29005
Micronair Purflux AHC318
Tecocar EC620 Fiaam PCK8278

--- Classe M (W163) ---

02/98 -> 06/05

*

*

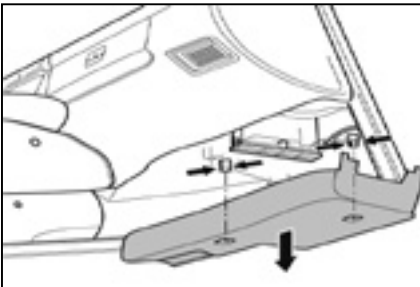

- I** Il filtro è posizionato nell'abitacolo dietro il vano portaoggetti
- GB** The filter is located in the passenger compartment behind the glove compartment
- F** Le filtre est situé dans l'habitacle derrière la boîte à gants
- D** Der filter befindet sich im Fahrgastraum hinter dem Handsuhfach
- E** El filtro se encuentra en el habitáculo detrás de la guantera

CK 8717

227 x 211 x 39,5



O/E numbers

Mercedes 1638350047 / 1638350247

Cross References

Fram CF8717 Mann CU2338
Micronair MP094 Purflux AH297
Tecocar..... Fiaam PC8238

CK 8717-C

227 x 211 x 39,5



O/E numbers

Mercedes 1638350147 / 66809903

Cross References

Fram CFA8717 Mann CUK2338
Micronair MC594 Purflux.....
Tecocar..... Fiaam PCK8160

--- Classe M (W164) ---

07/05 ->

*

*

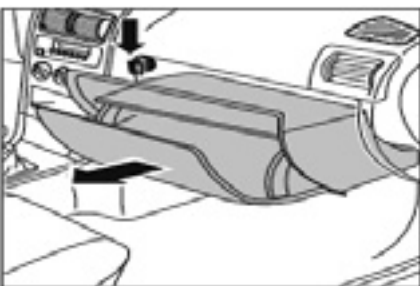

- I** Il filtro è posizionato nell'abitacolo dietro il vano portaoggetti
- GB** The filter is located in the passenger compartment behind the glove compartment
- F** Le filtre est situé dans l'habitacle derrière la boîte à gants
- D** Der filter befindet sich im Fahrgastraum hinter dem Handsuhfach
- E** El filtro se encuentra en el habitáculo detrás de la guantera

CK 2646-C-2

254 x 134 x 40



O/E numbers

Mercedes 1648300218

Cross References









Fram CFA10828-2 Mann CUK2646-2
Micronair MC738-2 Purflux AHC241
Tecocar..... Fiaam PCK8260-2

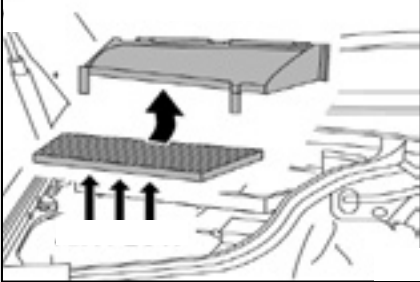
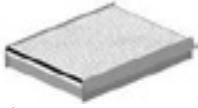

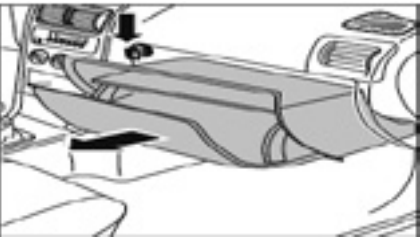
Anti-pollen

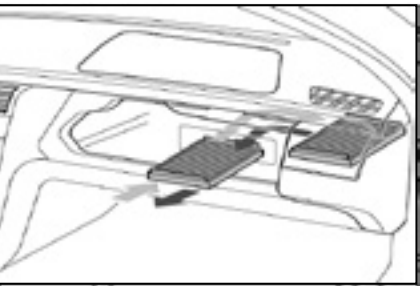
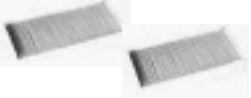
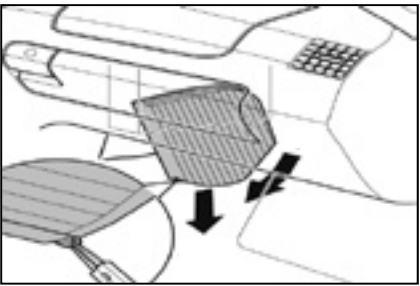
Activated carbon

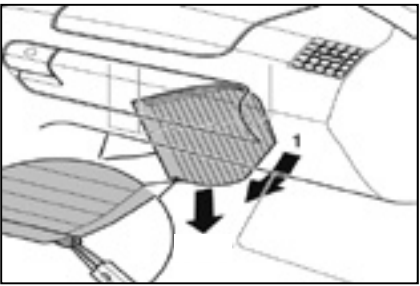
MERCEDES

<p>--- Classe M (W166) ---</p> 	<p>09-nov * *</p> <p>I Il filtro è posizionato nel vano motore sul lato passeggero sotto il coperchio della vaschetta del radiatore GB The filter is located in the engine compartment on the passenger's side under the radiator tank cover F Le filtre est situé dans le compartiment moteur du côté passager en dessous du cache du réservoir à eau D Der filter befindet sich Motorraum auf der Beifahrerseite unter der Wasserkastenabdeckung E El filtro se encuentra en el compartimiento del motor, lado del acompañante, bajo la cubierta del depósito del agua</p>	<p>CK 25002 247 x 190 x 32</p>  <p><u>O/E numbers</u> Mercedes 1668300018 / 1668300218 <u>Cross References</u> Fram CF11719 Mann CU25002 Micronair Purflux AH409 Tecnocar E700 Fiaam PC8379</p>	<p>CK 25002-C 247 x 190 x 32</p>  <p><u>O/E numbers</u> Mercedes <u>Cross References</u> Fram Mann Micronair Purflux..... Tecnocar..... Fiaam.....</p>
<p>--- Classe M (W164) ---</p> 	<p>09/05 -> * *</p> <p>I Il filtro è posizionato nell'abitacolo dietro il vano portaoggetti GB The filter is located in the passenger compartment behind the glove compartment F Le filtre est situé dans l'habitacle derrière la boîte à gants D Der filter befindet sich im Fahrgastraum hinter dem Handshuhfach E El filtro se encuentra en el habitáculo detrás de la guantera</p>	<p>---</p>	<p>CK 2646-C-2 254 x 134 x 40</p>  <p><u>O/E numbers</u> Mercedes 1648300218 <u>Cross References</u> Fram CFA10828-2 Mann CUK2646-2 Micronair MC738-2 Purflux AHC241 Tecnocar..... Fiaam PCK8260-2</p>
<p>--- Classe S (W220) ---</p> 	<p>10/98 -> 10/05 * *</p> <p>I Il filtro è posizionato nell'abitacolo sotto il vano portaoggetti GB The filter is located in the passenger compartment under the glove compartment F Le filtre est situé dans l'habitacle en dessous de la boîte à gants D Der filter befindet sich im Fahrgastraum unter dem Handshuhfach E El filtro se encuentra en el habitáculo, bajo la guantera de pasajerruimte</p>	<p>CK 5972-2 260/250 x 125/115 x 40</p>  <p><u>O/E numbers</u> Mercedes 2108300018 / 2108301018 <u>Cross References</u> Fram CF5972 Mann CU2745-2 Micronair MP022-2 Purflux AH137 Tecnocar E336 Fiaam PC8033</p>	<p>---</p>
<p>--- Classe SL (R231) ---</p> 	<p>02/12 -> * </p> <p>I Il filtro è posizionato nell'abitacolo sotto il vano portaoggetti GB The filter is located in the passenger compartment under the glove compartment F Le filtre est situé dans l'habitacle en dessous de la boîte à gants D Der filter befindet sich im Fahrgastraum unter dem Handshuhfach E El filtro se encuentra en el habitáculo, bajo la guantera de pasajerruimte</p>	<p>---</p>	<p>CK 29005-C 262 x 283 x 76</p>  <p><u>O/E numbers</u> Mercedes 2048300018 / 2048300518 <u>Cross References</u> Fram CFA10934 Mann CUK29005 Micronair Purflux AHC318 Tecnocar EC620 Fiaam PCK8278</p>
<p>--- Classe SLK (R170) ---</p> 	<p>09/06 -> 04/00 * *</p> <p>I Il filtro è posizionato nell'abitacolo sotto il vano portaoggetti GB The filter is located in the passenger compartment under the glove compartment F Le filtre est situé dans l'habitacle en dessous de la boîte à gants D Der filter befindet sich im Fahrgastraum unter dem Handshuhfach E El filtro se encuentra en el habitáculo, bajo la guantera de pasajerruimte</p>	<p>CK 5842 274/264 x 215/205 x35/53</p>  <p><u>O/E numbers</u> Mercedes 2028300018 / 2028300318 <u>Cross References</u> Fram CF5842 Mann CU2897 Micronair MP005 Purflux AH138 Tecnocar E337 Fiaam PC8016</p>	<p>CK 5842-C 278/262 x 216/206 x 54</p>  <p><u>O/E numbers</u> Mercedes 2108300818 / 2108301218 <u>Cross References</u> Fram CFA8877 Mann CUK2897 Micronair MC612 Purflux AHC138 Tecnocar..... Fiaam PCK8065</p>



Anti-pollen

Activated carbon

MERCEDES

--- Classe SLS AMG (C197) ---

03/10 -> * *

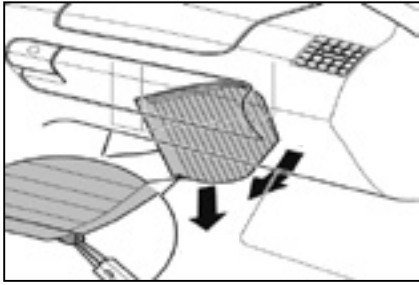

- I** Il filtro è posizionato nell'abitacolo sotto il vano portaoggetti
- GB** The filter is located in the passenger compartment under the glove compartment
- F** Le filtre est situé dans l'habitacle en dessous de la boîte à gants
- D** Der filter befindet sich im Fahrgastraum unter dem Handshuhfach
- E** El filtro se encuentra en el habitáculo, bajo la guanterain de pasajeriunte

CK 29005-C
262 x 283 x 76



O/E numbers
Mercedes 2048300018 / 2048300518
Cross References
Fram CFA10934 Mann CUK29005
Micronair Purflux AHC318
Tecocar EC620 Fiaam PCK8278

--- Classe V (638/2) ---

04/96 -> 10/03 * *

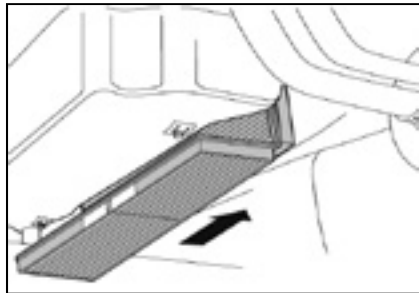

- I** Il filtro è posizionato nel vano motore
- GB** The filter is located in the engine compartment
- F** Le filtre est situé dans le compartiment moteur
- D** Der Filter befindet sich im Motorraum
- E** El filtro se encuentra en el compartimiento del motor

CK 9383

371 x 212 x 25



O/E numbers
Mercedes 6388350047 / 0018353047
Cross References
Fram CF9383 Mann CU3759
Micronair MP023 Purflux AH159
Tecocar E360 Fiaam PC8115

--- Maybach (W240) ---

09/02 -> 12/12 * *

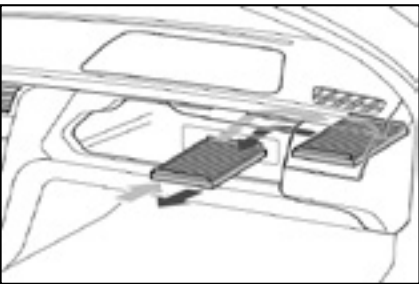

- I** Il filtro è posizionato nell'abitacolo sotto il vano portaoggetti
- GB** The filter is located in the passenger compartment under the glove compartment
- F** Le filtre est situé dans l'habitacle en dessous de la boîte à gants
- D** Der filter befindet sich im Fahrgastraum unter dem Handshuhfach
- E** El filtro se encuentra en el habitáculo, bajo la guanterain de pasajeriunte

CK 5972-2

260/250 x 125/115 x 40



O/E numbers
Mercedes 2108300018 / 2108301018
Cross References
Fram CF5972 Mann CU2745-2
Micronair MP022-2 Purflux AH137
Tecocar E336 Fiaam PC8033

--- Sprinter I ---

02/95 -> 05/06 * *

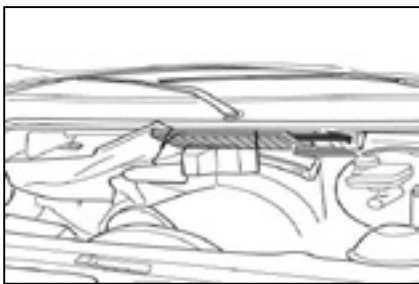

- I** Il filtro è posizionato nel vano motore al centro
- GB** The filter is located in the engine compartment centrally
- F** Le filtre est situé dans le compartiment moteur au centre
- D** Der Filter befindet sich im Motorraum mitting
- E** El filtro se encuentra en el compartimiento del motor, en el centro

CK 9051

375 x 164 x 27,5



O/E numbers
Mercedes 0008303318 / 9018300018
Cross References
Fram CF9051 Mann CU3858
Micronair MP020 Purflux AH158
Tecocar E376 Fiaam PC8058

CK 9051-C

375 x 164 x 27,5



O/E numbers
Mercedes 9018300418
Cross References
Fram..... Mann CUK3858
Micronair MC520 Purflux.....
Tecocar..... Fiaam.....

--- Sprinter II ---

04/06 -> * *



- I** Il filtro è posizionato nel vano motore
- GB** The filter is located in the engine compartment
- F** Le filtre est situé dans le compartiment moteur
- D** Der Filter befindet sich im Motorraum
- E** El filtro se encuentra en el compartimiento del motor

CK 10436-10

351 x 233 x 35



O/E numbers
Mercedes A9068300218
Cross References
Fram CF10436 Mann CU3569
Micronair MP177 Purflux AH268
Tecocar E470 Fiaam PC8199

CK 10436-10-C

351 x 233 x 35



O/E numbers
Mercedes A9068300318
Cross References
Fram CFA10436 Mann CUK3569
Micronair MC677 Purflux AHC268
Tecocar EC470 Fiaam PCK8199



Anti-pollen

Activated carbon

MERCEDES

--- Sprinter Classic ---

09/13 ->

*

*



- Il filtro è posizionato nel vano motore al centro
- The filter is located in the engine compartment centrally
- Le filtre est situé dans le compartiment moteur au centre
- Der Filter befindet sich im Motorraum mitting
- El filtro se encuentra en el compartimiento del motor, en el centro

CK 9051

375 x 164 x 27,5



O/E numbers

Mercedes 0008303318 / 9018300018

Cross References

Fram CF9051 Mann CU3858
Micronair MP020 Purflux AH158
Tecocar E376 Fiaam PC8058

CK 9051-C

375 x 164 x 27,5



O/E numbers

Mercedes 9018300418

Cross References

Fram..... Mann CUK3858
Micronair MC520 Purflux.....
Tecocar..... Fiaam.....

--- Vaneo (W414) ---

09/01 -> 09/05

*

*

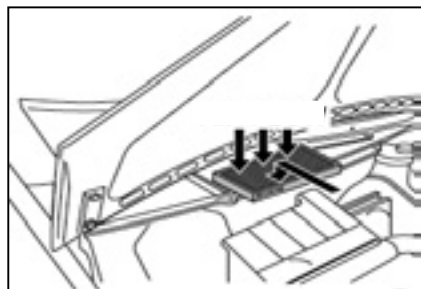

- Il filtro è posizionato nel vano motore al centro
- The filter is located in the engine compartment centrally
- Le filtre est situé dans le compartiment moteur au centre
- Der Filter befindet sich im Motorraum mitting
- El filtro se encuentra en el compartimiento del motor, en el centro

CK 8777

364 x 252 x 25



O/E numbers

Mercedes 1688300018

Cross References

Fram CF8777 Mann CU3780
Micronair MP037 Purflux AH126
Tecocar E327 Fiaam PC8035

CK 8777-C

364 x 252 x 25



O/E numbers

Mercedes 1688300118 / 1688300818

Cross References

Fram..... Mann CUK3780
Micronair MC537 Purflux AHC126
Tecocar..... Fiaam.....

--- Viano ---

09/03 ->

*

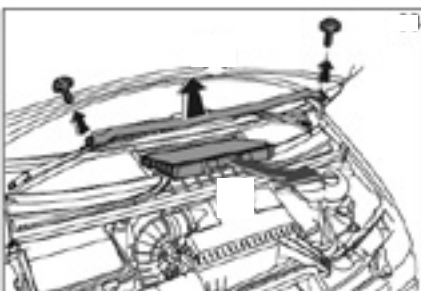

- Il filtro è posizionato nel vano motore al centro
- The filter is located in the engine compartment centrally
- Le filtre est situé dans le compartiment moteur au centre
- Der Filter befindet sich im Motorraum mitting
- El filtro se encuentra en el compartimiento del motor, en el centro

CK 3540

360 x 208 x 33,5



O/E numbers

Mercedes 6398350247

Cross References

Fram CF10621 Mann CU3540
Micronair MP148 Purflux AH280
Tecocar..... Fiaam PC8230

CK 3540-C

360 x 208 x 33,5



O/E numbers

Mercedes 6398350347

Cross References

Fram CFA10621 Mann CUK3540
Micronair MC648 Purflux AHC280
Tecocar..... Fiaam PCK8230

--- Vito I (638) ---

11/95 -> 10/03

*

*

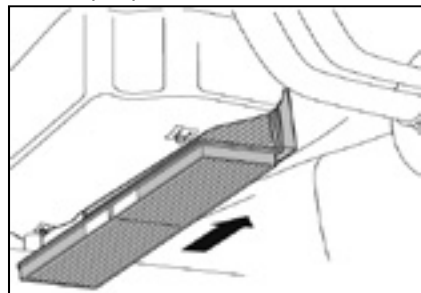

- Il filtro è posizionato nel vano motore
- The filter is located in the engine compartment
- Le filtre est situé dans le compartiment moteur
- Der Filter befindet sich im Motorraum
- El filtro se encuentra en el compartimiento del motor

CK 9383

371 x 212 x 25



O/E numbers

Mercedes 6388350047 / 0018353047

Cross References

Fram CF9383 Mann CU3759
Micronair MP023 Purflux AH159
Tecocar E360 Fiaam PC8115

--- Vito II (639) ---

09/03 ->

*

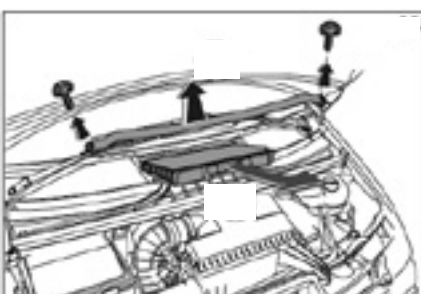

- Il filtro è posizionato nel vano motore al centro
- The filter is located in the engine compartment centrally
- Le filtre est situé dans le compartiment moteur au centre
- Der Filter befindet sich im Motorraum mitting
- El filtro se encuentra en el compartimiento del motor, en el centro

CK 3540

360 x 208 x 33,5



O/E numbers

Mercedes 6398350247

Cross References

Fram CF10621 Mann CU3540
Micronair MP148 Purflux AH280
Tecocar..... Fiaam PC8230

CK 3540-C

360 x 208 x 33,5



O/E numbers

Mercedes 6398350347

Cross References

Fram CFA10621 Mann CUK3540
Micronair MC648 Purflux AHC280
Tecocar..... Fiaam PCK8230



Anti-pollen

Activated carbon

MINI

--- Mini One I ---

05/01 -> 09/08 * *

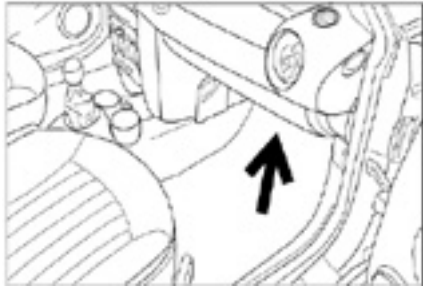

- ① Il filtro è posizionato nell'abitacolo sotto il vano portaoggetti
- Ⓒ The filter is located in the passenger compartment under the glove compartment
- Ⓕ Le filtre est situé dans l'habitacle en dessous de la boîte à gants
- Ⓓ Der filter befindet sich im Fahrgastraum unter dem Handschuhfach
- Ⓔ El filtro se encuentra en el habitáculo, bajo la guantera de pasajerruimte

CK 9594

473 x 119 x 34,5



O/E numbers

Mini / Bmw 64311496710

Cross References

Fram CF9594 Mann CU4624
Micronair MP130 Purflux AH192
Tecocar..... Fiaam PC8113

CK 9594-C

473 x 119 x 34,5



O/E numbers

Mini / Bmw 64311496711

Cross References

Fram CFA9594 Mann CUK4624
Micronair MC630 Purflux.....
Tecocar EC395 Fiaam PCK8113

--- Mini One II ---

04/07 ->

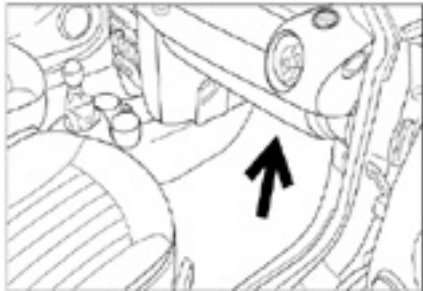

- ① Il filtro è posizionato nell'abitacolo sotto il vano portaoggetti
- Ⓒ The filter is located in the passenger compartment under the glove compartment
- Ⓕ Le filtre est situé dans l'habitacle en dessous de la boîte à gants
- Ⓓ Der filter befindet sich im Fahrgastraum unter dem Handschuhfach
- Ⓔ El filtro se encuentra en el habitáculo, bajo la guantera de pasajerruimte

CK 4436

439 x 119 x 31



O/E numbers

Mini / Bmw 64319127515

Cross References

Fram CF10831 Mann CU4436
Micronair MP287 Purflux AH300
Tecocar E610 Fiaam PC8263

CK 4436-C

473 x 119 x 34,5



O/E numbers

Mini / Bmw 64319127516

Cross References

Fram CFA10831 Mann CUK4436
Micronair MC787 Purflux AHC300
Tecocar EC610 Fiaam PCK8263

--- Mini Cooper I ---

05/01 -> 09/08 * *

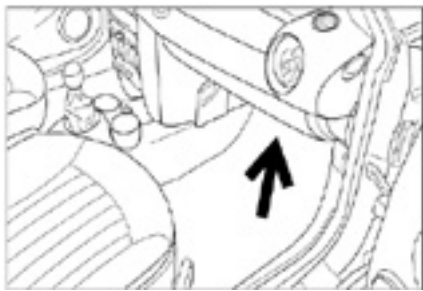

- ① Il filtro è posizionato nell'abitacolo sotto il vano portaoggetti
- Ⓒ The filter is located in the passenger compartment under the glove compartment
- Ⓕ Le filtre est situé dans l'habitacle en dessous de la boîte à gants
- Ⓓ Der filter befindet sich im Fahrgastraum unter dem Handschuhfach
- Ⓔ El filtro se encuentra en el habitáculo, bajo la guantera de pasajerruimte

CK 9594

473 x 119 x 34,5



O/E numbers

Mini / Bmw 64311496710

Cross References

Fram CF9594 Mann CU4624
Micronair MP130 Purflux AH192
Tecocar..... Fiaam PC8113

CK 9594-C

473 x 119 x 34,5



O/E numbers

Mini / Bmw 64311496711

Cross References

Fram CFA9594 Mann CUK4624
Micronair MC630 Purflux.....
Tecocar EC395 Fiaam PCK8113

--- Mini Cooper II ---

11/06 ->

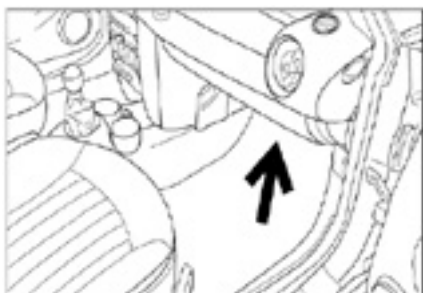

- ① Il filtro è posizionato nell'abitacolo sotto il vano portaoggetti
- Ⓒ The filter is located in the passenger compartment under the glove compartment
- Ⓕ Le filtre est situé dans l'habitacle en dessous de la boîte à gants
- Ⓓ Der filter befindet sich im Fahrgastraum unter dem Handschuhfach
- Ⓔ El filtro se encuentra en el habitáculo, bajo la guantera de pasajerruimte

CK 4436

439 x 119 x 31



O/E numbers

Mini / Bmw 64319127515

Cross References

Fram CF10831 Mann CU4436
Micronair MP287 Purflux AH300
Tecocar E610 Fiaam PC8263

CK 4436-C

473 x 119 x 34,5



O/E numbers

Mini / Bmw 64319127516

Cross References

Fram CFA10831 Mann CUK4436
Micronair MC787 Purflux AHC300
Tecocar EC610 Fiaam PCK8263

--- Mini III (F54, F55, F56) ---

02/14 -> * *

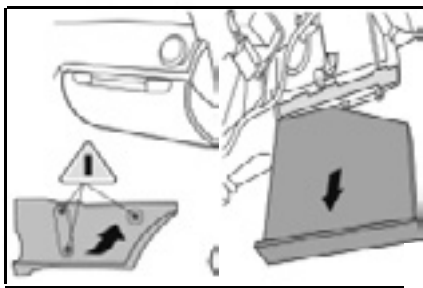

- ① Il filtro è posizionato nell'abitacolo sotto il vano portaoggetti
- Ⓒ The filter is located in the passenger compartment under the glove compartment
- Ⓕ Le filtre est situé dans l'habitacle en dessous de la boîte à gants
- Ⓓ Der filter befindet sich im Fahrgastraum unter dem Handschuhfach
- Ⓔ El filtro se encuentra en el habitáculo, bajo la guantera de pasajerruimte

CK 23005-C-2

232 x 116 x 32



O/E numbers

Bmw 64119321875 / 64319297750

Cross References



Fram CFA11815-2 Mann CUK23005-2
Micronair Pufflux AHC428-2
Tecocar EC722-2 Fiaam PCK8408-2





Anti-pollen

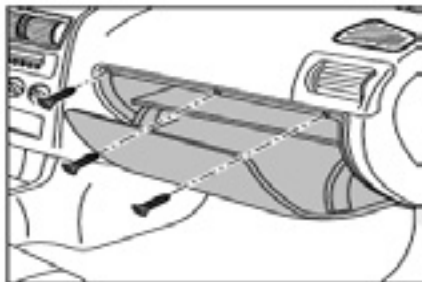

Activated carbon

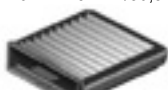

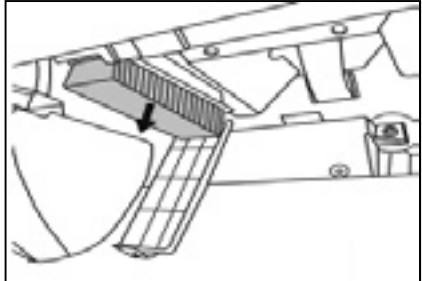
MITSUBISHI

<p>--- ASX ---</p>  <p> I Il filtro è posizionato nell'abitacolo dietro il vano portaoggetti GB The filter is located in the passenger compartment behind the glove compartment F Le filtre est situé dans l'habitacle derrière la boîte à gants D Der filter befindet sich im Fahrgastraum hinter dem Handschuhfach E El filtro se encuentra en el habitáculo detrás de la guantera </p>	<p>04/10 -> * *</p>	<p>CK 10431 217 x 200 x 30</p>  <p><u>O/E numbers</u> Mitsubishi 780A004</p> <p><u>Cross References</u> Fram CF10431 Mann CU2141 Micronair MP247 Purflux AH262 Tecocar E472 Fiaam PC8201</p>	<p>CK 10431-C 217 x 200 x 30</p>  <p><u>O/E numbers</u> Mitsubishi 780A005</p> <p><u>Cross References</u> Fram CAF10431 Mann CUK2141 Micronair MC747 Purflux AHC262 Tecocar EC472 Fiaam PCK8201</p>
--	----------------------------------	--	--

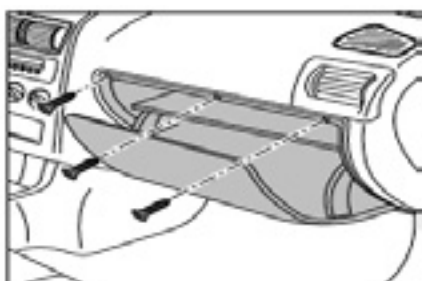
<p>--- Carisma ---</p>  <p> I Il filtro è posizionato nell'abitacolo dietro il vano portaoggetti GB The filter is located in the passenger compartment behind the glove compartment F Le filtre est situé dans l'habitacle derrière la boîte à gants D Der filter befindet sich im Fahrgastraum hinter dem Handschuhfach E El filtro se encuentra en el habitáculo detrás de la guantera </p>	<p>07/95 -> 06/06 * *</p>	<p>CK 9880 194 x 175 x 42/50,5</p>  <p><u>O/E numbers</u> Mitsubishi MZ311916 / XZ311916</p> <p><u>Cross References</u> Fram CF9880 Mann CU1915 Micronair MP349 Purflux AH148 Tecocar E350 Fiaam.....</p>	<p>---</p>
--	--	---	------------

<p>--- Colt VI ---</p>  <p> I Il filtro è posizionato nell'abitacolo dietro il vano portaoggetti GB The filter is located in the passenger compartment behind the glove compartment F Le filtre est situé dans l'habitacle derrière la boîte à gants D Der filter befindet sich im Fahrgastraum hinter dem Handschuhfach E El filtro se encuentra en el habitáculo detrás de la guantera </p>	<p>04/04 -> * *</p>	<p>---</p>	<p>CK 1830-C 202 x 178 x 40</p>  <p><u>O/E numbers</u> Mitsubishi MR958017</p> <p><u>Cross References</u> Fram CFA10582 Mann CUK1830 Micronair MC670 Purflux AHC278 Tecocar EC494 Fiaam PCK8229</p>
--	----------------------------------	------------	--

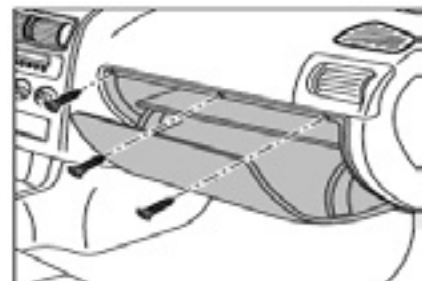
<p>--- Lancer VIII ---</p>  <p> I Il filtro è posizionato nell'abitacolo dietro il vano portaoggetti GB The filter is located in the passenger compartment behind the glove compartment F Le filtre est situé dans l'habitacle derrière la boîte à gants D Der filter befindet sich im Fahrgastraum hinter dem Handschuhfach E El filtro se encuentra en el habitáculo detrás de la guantera </p>	<p>10/07 -> * *</p>	<p>CK 10431 217 x 200 x 30</p>  <p><u>O/E numbers</u> Mitsubishi 780A004</p> <p><u>Cross References</u> Fram CF10431 Mann CU2141 Micronair MP247 Purflux AH262 Tecocar E472 Fiaam PC8201</p>	<p>CK 10431-C 217 x 200 x 30</p>  <p><u>O/E numbers</u> Mitsubishi 780A005</p> <p><u>Cross References</u> Fram CAF10431 Mann CUK2141 Micronair MC747 Purflux AHC262 Tecocar EC472 Fiaam PCK8201</p>
--	----------------------------------	--	--









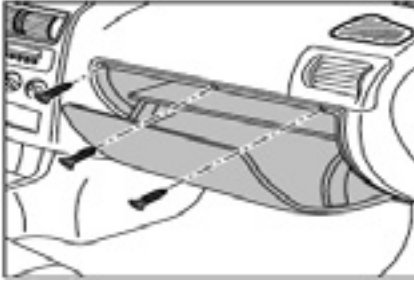

<p>--- Montero ---</p>  <p> I Il filtro è posizionato nell'abitacolo dietro il vano portaoggetti GB The filter is located in the passenger compartment behind the glove compartment F Le filtre est situé dans l'habitacle derrière la boîte à gants D Der filter befindet sich im Fahrgastraum hinter dem Handschuhfach E El filtro se encuentra en el habitáculo detrás de la guantera </p>	<p>03/10 -> * *</p>	<p>---</p>	<p>CK 2230-C 217 x 215 x 30/67</p>  <p><u>O/E numbers</u> Mitsubishi 7803A028 / MR500058</p> <p><u>Cross References</u> Fram CFA11767 Mann CUK2230 Micronair MC855 Purflux AHC418 Tecocar EC710 Fiaam PCK8388</p>
--	----------------------------------	------------	--

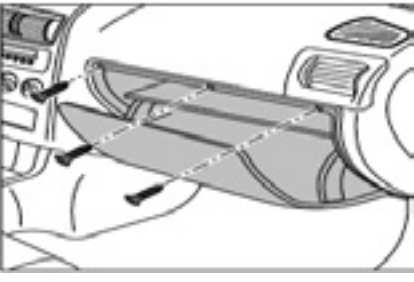

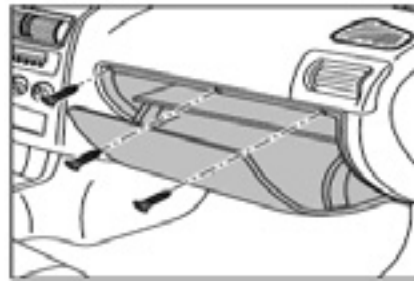
Anti-pollen

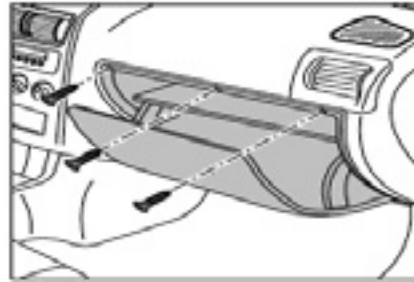
Activated carbon

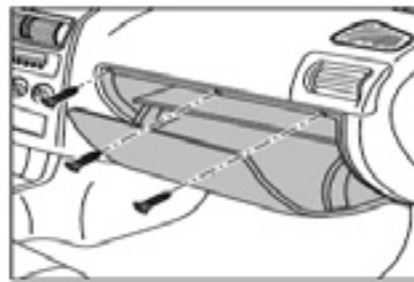
MITSUBISHI

<p>--- Outlander II ---</p>  <p> I Il filtro è posizionato nell'abitacolo dietro il vano portaoggetti GB The filter is located in the passenger compartment behind the glove compartment F Le filtre est situé dans l'habitacle derrière la boîte à gants D Der filter befindet sich im Fahrgastraum hinter dem Handsuhfach E El filtro se encuentra en el habitáculo detrás de la guantera </p>	<p>11/06 -></p>	<p>*</p>	<p>*</p>	<p>CK 10431 217 x 200 x 30</p>  <p><u>O/E numbers</u> Mitsubishi 780A004 <u>Cross References</u> Fram CF10431 Mann CU2141 Micronair MP247 Purflux AH262 Tecocar E472 Fiaam PC8201</p>	<p>CK 10431-C 217 x 200 x 30</p>  <p><u>O/E numbers</u> Mitsubishi 780A005 <u>Cross References</u> Fram CAF10431 Mann CUK2141 Micronair MC747 Purflux AHC262 Tecocar EC472 Fiaam PCK8201</p>
<p>--- Outlander III ---</p>  <p> I Il filtro è posizionato nell'abitacolo dietro il vano portaoggetti GB The filter is located in the passenger compartment behind the glove compartment F Le filtre est situé dans l'habitacle derrière la boîte à gants D Der filter befindet sich im Fahrgastraum hinter dem Handsuhfach E El filtro se encuentra en el habitáculo detrás de la guantera </p>	<p>07/12 -></p>	<p>*</p>	<p>*</p>	<p>CK 10431 217 x 200 x 30</p>  <p><u>O/E numbers</u> Mitsubishi 780A004 <u>Cross References</u> Fram CF10431 Mann CU2141 Micronair MP247 Purflux AH262 Tecocar E472 Fiaam PC8201</p>	<p>CK 10431-C 217 x 200 x 30</p>  <p><u>O/E numbers</u> Mitsubishi 780A005 <u>Cross References</u> Fram CAF10431 Mann CUK2141 Micronair MC747 Purflux AHC262 Tecocar EC472 Fiaam PCK8201</p>
<p>--- Pajero I ---</p>  <p> I Il filtro è posizionato nell'abitacolo dietro il vano portaoggetti GB The filter is located in the passenger compartment behind the glove compartment F Le filtre est situé dans l'habitacle derrière la boîte à gants D Der filter befindet sich im Fahrgastraum hinter dem Handsuhfach E El filtro se encuentra en el habitáculo detrás de la guantera </p>	<p>03/10 -> 12/91</p>	<p></p>	<p></p>	<p>---</p>	<p>CK 2230-C 217 x 215 x 30/67</p>  <p><u>O/E numbers</u> Mitsubishi 7803A028 / MR500058 <u>Cross References</u> Fram CFA11767 Mann CUK2230 Micronair MC855 Purflux AHC418 Tecocar EC710 Fiaam PCK8388</p>
<p>--- Pajero II ---</p>  <p> I Il filtro è posizionato nell'abitacolo dietro il vano portaoggetti GB The filter is located in the passenger compartment behind the glove compartment F Le filtre est situé dans l'habitacle derrière la boîte à gants D Der filter befindet sich im Fahrgastraum hinter dem Handsuhfach E El filtro se encuentra en el habitáculo detrás de la guantera </p>	<p>12/90 -> 04/00</p>	<p></p>	<p></p>	<p>---</p>	<p>CK 2230-C 217 x 215 x 30/67</p>  <p><u>O/E numbers</u> Mitsubishi 7803A028 / MR500058 <u>Cross References</u> Fram CFA11767 Mann CUK2230 Micronair MC855 Purflux AHC418 Tecocar EC710 Fiaam PCK8388</p>
<p>--- Pajero III ---</p>  <p> I Il filtro è posizionato nell'abitacolo dietro il vano portaoggetti GB The filter is located in the passenger compartment behind the glove compartment F Le filtre est situé dans l'habitacle derrière la boîte à gants D Der filter befindet sich im Fahrgastraum hinter dem Handsuhfach E El filtro se encuentra en el habitáculo detrás de la guantera </p>	<p>11/99 -></p>	<p></p>	<p></p>	<p>---</p>	<p>CK 2230-C 217 x 215 x 30/67</p>  <p><u>O/E numbers</u> Mitsubishi 7803A028 / MR500058 <u>Cross References</u> Fram CFA11767 Mann CUK2230 Micronair MC855 Purflux AHC418 Tecocar EC710 Fiaam PCK8388</p>



Anti-pollen

Activated carbon

MITSUBISHI

--- Pajero IV ---

11/99 ->

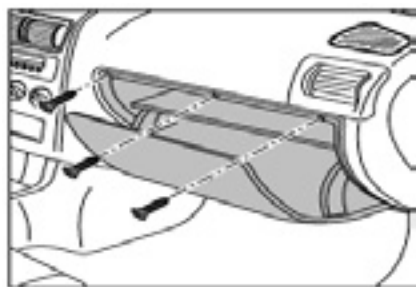

- I** Il filtro è posizionato nell'abitacolo dietro il vano portaoggetti
- GB** The filter is located in the passenger compartment behind the glove compartment
- F** Le filtre est situé dans l'habitacle derrière la boîte à gants
- D** Der filter befindet sich im Fahrgastraum hinter dem Handshuhfach
- E** El filtro se encuentra en el habitáculo detrás de la guantera

CK 2230-C

217 x 215 x 30/67



O/E numbers

Mitsubishi 7803A028 / MR500058

Cross References

Fram CFA11767 Mann CUK2230
 Micronair MC855 Purflux AHC418
 Tecocar EC710 Fiaam PCK8388

--- Space Star ---

10/98 -> 12/04 *



- I** Il filtro è posizionato nell'abitacolo dietro il vano portaoggetti
- GB** The filter is located in the passenger compartment behind the glove compartment
- F** Le filtre est situé dans l'habitacle derrière la boîte à gants
- D** Der filter befindet sich im Fahrgastraum hinter dem Handshuhfach
- E** El filtro se encuentra en el habitáculo detrás de la guantera

CK 9880

194 x 175 x 42/50,5



O/E numbers

Mitsubishi MZ311916 / XZ311916

Cross References

Fram CF9880 Mann CU1915
 Micronair MP349 Purflux AH148
 Tecocar E350 Fiaam.....

--	--	--

--	--	--

--	--	--



Anti-pollen

Activated carbon

NISSAN

--- Almera II (N16) ---

03/00 -> * *

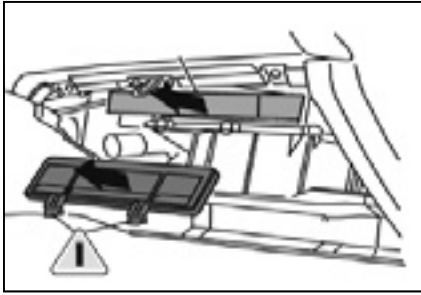

- 1 Il filtro è posizionato nell'abitacolo dietro il vano portaoggetti
- 2 The filter is located in the passenger compartment behind the glove compartment
- 3 Le filtre est situé dans l'habitacle derrière la boîte à gants
- 4 Der filter befindet sich im Fahrgastraum hinter dem Handschuhfach
- 5 El filtro se encuentra en el habitáculo detrás de la guantera

CK 9363

222 x 200 x 30



O/E numbers

Nissan 27891BM401 / 27891BM401KE

Cross References

Fram CF9363 Mann CU2345
Micronair MP063 Purflux AH204
Tecocar E407 Fiaam PC8083

--- Almera Classic ---

03/06 -> * *

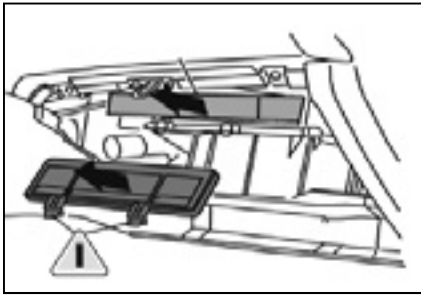

- 1 Il filtro è posizionato nell'abitacolo dietro il vano portaoggetti
- 2 The filter is located in the passenger compartment behind the glove compartment
- 3 Le filtre est situé dans l'habitacle derrière la boîte à gants
- 4 Der filter befindet sich im Fahrgastraum hinter dem Handschuhfach
- 5 El filtro se encuentra en el habitáculo detrás de la guantera

CK 9363

222 x 200 x 30



O/E numbers

Nissan 27891BM401 / 27891BM401KE

Cross References

Fram CF9363 Mann CU2345
Micronair MP063 Purflux AH204
Tecocar E407 Fiaam PC8083

--- Almera Tino ---

07/00 -> * *

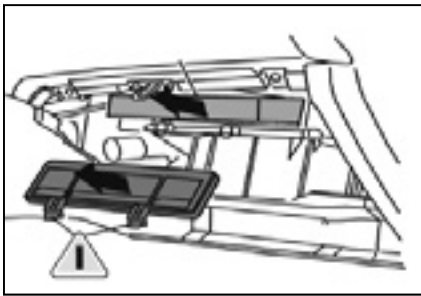

- 1 Il filtro è posizionato nell'abitacolo dietro il vano portaoggetti
- 2 The filter is located in the passenger compartment behind the glove compartment
- 3 Le filtre est situé dans l'habitacle derrière la boîte à gants
- 4 Der filter befindet sich im Fahrgastraum hinter dem Handschuhfach
- 5 El filtro se encuentra en el habitáculo detrás de la guantera

CK 9363

222 x 200 x 30



O/E numbers

Nissan 27891BM401 / 27891BM401KE

Cross References

Fram CF9363 Mann CU2345
Micronair MP063 Purflux AH204
Tecocar E407 Fiaam PC8083

--- Cube ---

08/09 -> *

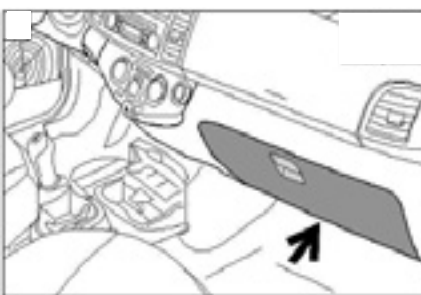

- 1 Il filtro è posizionato nell'abitacolo sotto il vano portaoggetti
- 2 The filter is located in the passenger compartment under the glove compartment
- 3 Le filtre est situé dans l'habitacle en dessous de la boîte à gants
- 4 Der filter befindet sich im Fahrgastraum unter dem Handschuhfach
- 5 El filtro se encuentra en el habitáculo, bajo la guantera in de pasajerruimte

CK 11177

260 x 149 x 25



O/E numbers

Nissan 278911FC0A / 278911FE0A

Cross References

Fram CF11177 Mann CU15001
Micronair MP405 Purflux AH356
Tecocar E649 Fiaam PC8326

CK 11177-C

260 x 149 x 25



O/E numbers

Nissan

Cross References

Fram Mann
Micronair Purflux
Tecocar Fiaam

--- Juke ---

09/10 -> * *

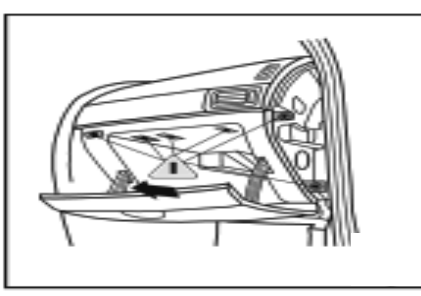

- 1 Il filtro è posizionato nell'abitacolo dietro il vano portaoggetti
- 2 The filter is located in the passenger compartment behind the glove compartment
- 3 Le filtre est situé dans l'habitacle derrière la boîte à gants
- 4 Der filter befindet sich im Fahrgastraum hinter dem Handschuhfach
- 5 El filtro se encuentra en el habitáculo detrás de la guantera

CK 1629

238 x 152 x 32



O/E numbers

Nissan 272771KA0A / 2727700A26

Cross References

Fram CF11119 Mann CU1629
Micronair MP413 Purflux AH306
Tecocar E708 Fiaam PC8264

CK 1629-C

238 x 152 x 32



O/E numbers

Nissan 271T200A00

Cross References

Fram CFA11119 Mann CUK1629
Micronair MC913 Purflux AHC309
Tecocar..... Fiaam PCK8264



Anti-pollen

Activated carbon

NISSAN

--- Kubistar ---

09/03 ->

*



- 1 Il filtro è posizionato nel vano motore
- 2 The filter is located in the engine compartment
- 3 Le filtre est situé dans le compartiment moteur
- 4 Der Filter befindet sich im Motorraum
- 5 El filtro se encuentra en el compartimiento del motor

CK 8838

229 x 159 x 30



O/E numbers

Nissan 2789100QAA

Cross References

Fram CF8838 Mann CU2945
Micronair MP033 Purflux AH143
Tecnocar E344 Fiaam PC8059

CK 8838-C

229 x 159 x 30



O/E numbers

Nissan.....

Cross References

Fram CFA8838 Mann CUK2945
Micronair MC533 Purflux AHC143
Tecnocar EC344 Fiaam PCK8059

--- Leaf ---

11/10 ->

*

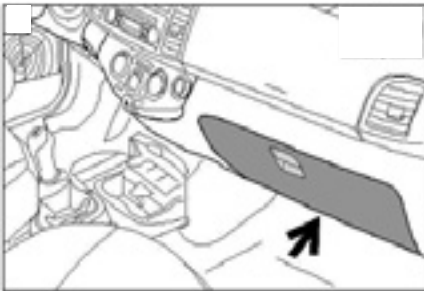

- 1 Il filtro è posizionato nell'abitacolo sotto il vano portaoggetti
- 2 The filter is located in the passenger compartment under the glove compartment
- 3 Le filtre est situé dans l'habitacle en dessous de la boîte à gants
- 4 Der filter befindet sich im Fahrgastraum unter dem Handshuhfach
- 5 El filtro se encuentra en el habitáculo, bajo la guanterain de pasajgeriurimte

CK 11177

260 x 149 x 25



O/E numbers

Nissan 278911FC0A / 278911FE0A

Cross References

Fram CF11177 Mann CU15001
Micronair MP405 Purflux AH356
Tecnocar E649 Fiaam PC8326

CK 11177-C

260 x 149 x 25



O/E numbers

Nissan

Cross References

Fram Mann
Micronair Purflux
Tecnocar Fiaam

--- Livina ---

02/07 ->

*

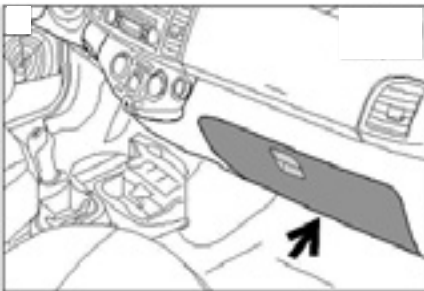

- 1 Il filtro è posizionato nell'abitacolo sotto il vano portaoggetti
- 2 The filter is located in the passenger compartment under the glove compartment
- 3 Le filtre est situé dans l'habitacle en dessous de la boîte à gants
- 4 Der filter befindet sich im Fahrgastraum unter dem Handshuhfach
- 5 El filtro se encuentra en el habitáculo, bajo la guanterain de pasajgeriurimte

CK 11177

260 x 149 x 25



O/E numbers

Nissan 278911FC0A / 278911FE0A

Cross References

Fram CF11177 Mann CU15001
Micronair MP405 Purflux AH356
Tecnocar E649 Fiaam PC8326

CK 11177-C

260 x 149 x 25



O/E numbers

Nissan

Cross References

Fram Mann
Micronair Purflux
Tecnocar Fiaam

--- Micra II (K11) ---

02/98 -> 03/03

*



- 1 Il filtro è posizionato nell'abitacolo dietro il vano portaoggetti
- 2 The filter is located in the passenger compartment behind the glove compartment
- 3 Le filtre est situé dans l'habitacle derrière la boîte à gants
- 4 Der filter befindet sich im Fahrgastraum hinter dem Handshuhfach
- 5 El filtro se encuentra en el habitáculo detrás de la guantera

CK 2516

243 x 206 x 19,5



O/E numbers

Nissan 278936F600

Cross References

Fram CF10923 Mann CU2516
Micronair MP125 Purflux AH364
Tecnocar E658 Fiaam PC8334

--- Micra III (K12) ---

03/06 ->

*

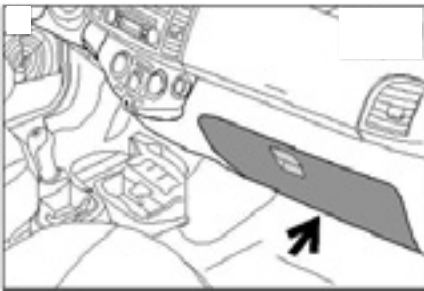

- 1 Il filtro è posizionato nell'abitacolo sotto il vano portaoggetti
- 2 The filter is located in the passenger compartment under the glove compartment
- 3 Le filtre est situé dans l'habitacle en dessous de la boîte à gants
- 4 Der filter befindet sich im Fahrgastraum unter dem Handshuhfach
- 5 El filtro se encuentra en el habitáculo, bajo la guanterain de pasajgeriurimte

CK 9691

205 x 181,5 x 27,5/42

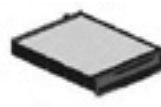

O/E numbers

Nissan 27891AX010

Cross References

Fram CF9691 Mann CU1829
Micronair MP179 Purflux AH207
Tecnocar E411 Fiaam PC8128



Anti-pollen

Activated carbon

NISSAN

--- Micra IV (K13) ---

02/06 -> *

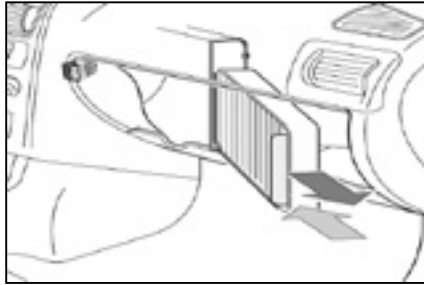

- ① Il filtro è posizionato nell'abitacolo dietro il vano portaoggetti
- ② The filter is located in the passenger compartment behind the glove compartment
- ③ Le filtre est situé dans l'habitacle derrière la boîte à gants
- ④ Der filter befindet sich im Fahrgastraum hinter dem Handshuhfach
- ⑤ El filtro se encuentra en el habitáculo detrás de la guantera

CK 23011

224 x 210 x 20



O/E numbers

Nissan 272771HD0B / 272771HE0E

Cross References

Fram CF11243 Mann CU23011
Micronair Purflux AH341
Tecocar E634 Fiaam PC8298

--- Murano ---

03/05 ->

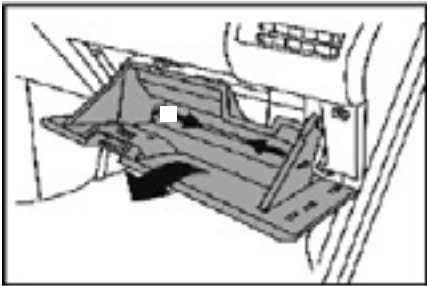

- ① Il filtro è posizionato nell'abitacolo sotto il vano portaoggetti
- ② The filter is located in the passenger compartment under the glove compartment
- ③ Le filtre est situé dans l'habitacle en dessous de la boîte à gants
- ④ Der filter befindet sich im Fahrgastraum unter dem Handshuhfach
- ⑤ El filtro se encuentra en el habitáculo, bajo la guantera en el compartimiento de pasajeros

CK 9882

216 x 200 x 30



O/E numbers

Nissan 27277M400 / 27277M425

Cross References

Fram CF9882 Mann CU2252
Micronair Purflux AH298
Tecocar E454 Fiaam PC8152

CK 9882-C

216 x 200 x 30



O/E numbers

Nissan 27277Z5000

Cross References

Fram Mann CUK2252
Micronair Purflux
Tecocar Fiaam

--- Navara / Hardbody ---

01/98 -> 10/01

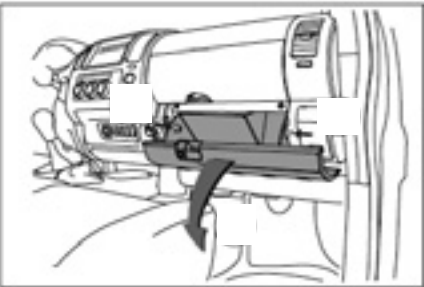

- ① Il filtro è posizionato nell'abitacolo dietro il vano portaoggetti
- ② The filter is located in the passenger compartment behind the glove compartment
- ③ Le filtre est situé dans l'habitacle derrière la boîte à gants
- ④ Der filter befindet sich im Fahrgastraum hinter dem Handshuhfach
- ⑤ El filtro se encuentra en el habitáculo detrás de la guantera

CK 2632-2

259 x 101,5 x 24,5



O/E numbers

Nissan 27274EA000

Cross References

Fram CF10533 Mann CU2623
Micronair MP266 Purflux AH337
Tecocar E630 Fiaam PC8294

--- Navara (D40) ---

06/05 ->

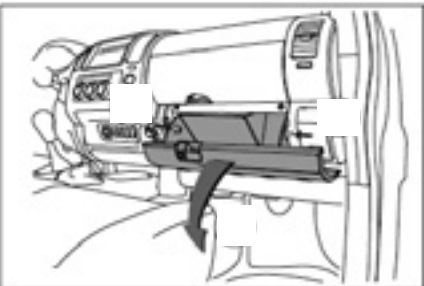

- ① Il filtro è posizionato nell'abitacolo dietro il vano portaoggetti
- ② The filter is located in the passenger compartment behind the glove compartment
- ③ Le filtre est situé dans l'habitacle derrière la boîte à gants
- ④ Der filter befindet sich im Fahrgastraum hinter dem Handshuhfach
- ⑤ El filtro se encuentra en el habitáculo detrás de la guantera

CK 2632-2

259 x 101,5 x 24,5



O/E numbers

Nissan 27274EA000

Cross References

Fram CF10533 Mann CU2623
Micronair MP266 Purflux AH337
Tecocar E630 Fiaam PC8294

--- Note (E11) ---

03/06 -> *

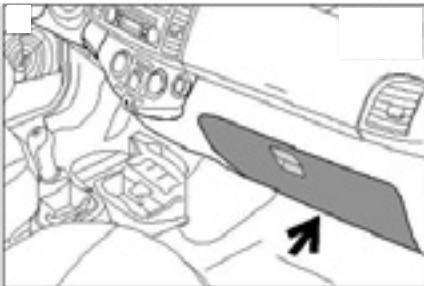

- ① Il filtro è posizionato nell'abitacolo sotto il vano portaoggetti
- ② The filter is located in the passenger compartment under the glove compartment
- ③ Le filtre est situé dans l'habitacle en dessous de la boîte à gants
- ④ Der filter befindet sich im Fahrgastraum unter dem Handshuhfach
- ⑤ El filtro se encuentra en el habitáculo, bajo la guantera en el compartimiento de pasajeros

CK 9691

205 x 181,5 x 27,5/42

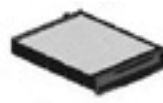

O/E numbers







Nissan 27891AX010

Cross References

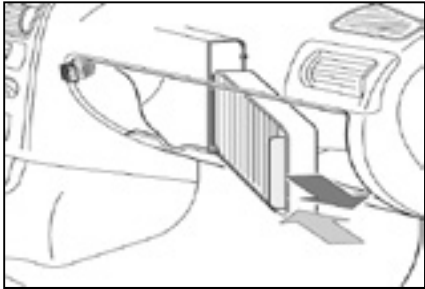
Fram CF9691 Mann CU1829
Micronair MP179 Purflux AH207
Tecocar E411 Fiaam PC8128

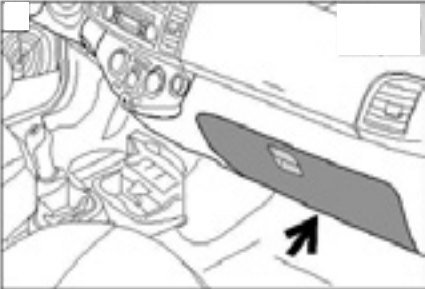
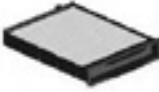
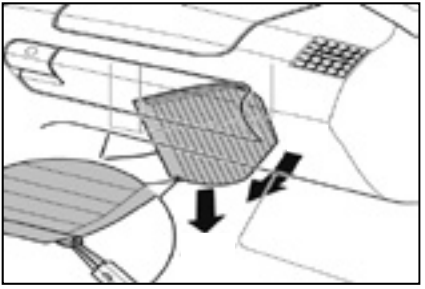

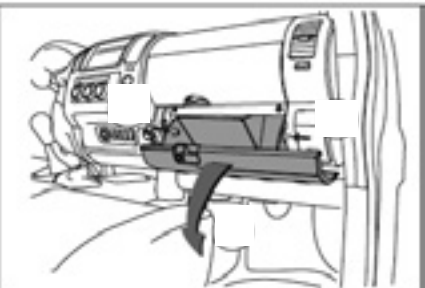
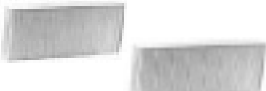
NISSAN

<p>--- Note (E12) ---</p> 	<p>09/13 -> * <input type="checkbox"/></p>	<p>CK 23011 224 x 210 x 20</p>  <p><u>O/E numbers</u> Nissan 272771HD0B / 272771HE0E</p> <p><u>Cross References</u> Fram CF11243 Mann CU23011 Micronair Purflux AH341 Tecocar E634 Fiaam PC8298</p>	
<p>--- NV200 --- vehicle manufacture Spain</p> 	<p>11/09 -> * <input type="checkbox"/></p>	<p>CK 9691 205 x 181,5 x 27,5/42</p>  <p><u>O/E numbers</u> Nissan 27891AX010</p> <p><u>Cross References</u> Fram CF9691 Mann CU1829 Micronair MP179 Purflux AH207 Tecocar E411 Fiaam PC8128</p>	
<p>--- NV400 ---</p> 	<p>10/11 -> * <input type="checkbox"/> * <input type="checkbox"/></p>	<p>CK 10534-2 239 x 108 x 20</p>  <p><u>O/E numbers</u> Nissan 2789100Q0D</p> <p><u>Cross References</u> Fram CF10534-2 Mann CU2418-2 Micronair MP276-2 Purflux AH273-2 Tecocar E487-2 Fiaam PC8217-2</p>	<p>CK 10534-C-2 239 x 108 x 20</p>  <p><u>O/E numbers</u> Nissan</p> <p><u>Cross References</u> Fram Mann Micronair Purflux AHC273 Tecocar..... Fiaam.....</p>
<p>--- Pathfinder ---</p> 	<p>03/05 -> <input type="checkbox"/> <input type="checkbox"/></p>	<p>CK 2632-2 259 x 101,5 x 24,5</p>  <p><u>O/E numbers</u> Nissan 27274EA000</p> <p><u>Cross References</u> Fram CF10533 Mann CU2623 Micronair MP266 Purflux AH337 Tecocar E630 Fiaam PC8294</p>	
<p>--- Pixo ---</p> 	<p>07/09 -> <input type="checkbox"/> <input type="checkbox"/></p>	<p>CK 17001 192 x 165 x 20</p>  <p><u>O/E numbers</u> Nissan 278914A00C</p> <p><u>Cross References</u> Fram CF10823 Mann CU17001 Micronair MP399 Purflux AH291 Tecocar E608 Fiaam PC8257</p>	



Anti-pollen

Activated carbon

NISSAN

--- Primastar ---

09/02 ->



- Il filtro è posizionato nel vano motore
- The filter is located in the engine compartment
- Le filtre est situé dans le compartiment moteur
- Der Filter befindet sich im Motorraum
- El filtro se encuentra en el compartimiento del motor

CK 9934

336 x 191/180 x 30/45



O/E numbers

Nissan 2729800QAA

Cross References

Fram CF9934 MannCU3454
Micronair MP223 Purflux AH186
Tecnocar E389 Fiaam PC8154

--- Primastar II ---

09/14 ->

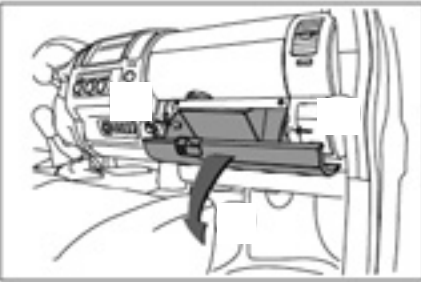

- Il filtro è posizionato nell'abitacolo dietro il vano portaoggetti
- The filter is located in the passenger compartment behind the glove compartment
- Le filtre est situé dans l'habitacle derrière la boîte à gants
- Der filter befindet sich im Fahrgastraum hinter dem Handshuhfach
- El filtro se encuentra en el habitáculo detrás de la guantera

CK 27001-C

263 x 196 x 38



O/E numbers

Nissan

Cross References

Fram CFA10761 Mann CUK27001
Micronair MC907 Purflux AHC284
Tecnocar EC601 Fiaam PCK8253

--- Primera II ---

06/96 -> 07/02

*

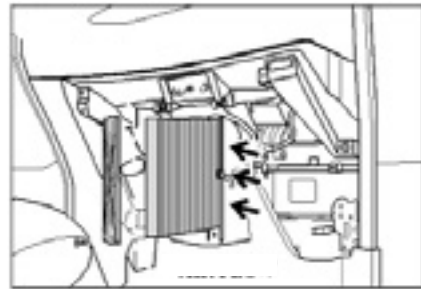

- Il filtro è posizionato nell'abitacolo dietro il vano portaoggetti
- The filter is located in the passenger compartment behind the glove compartment
- Le filtre est situé dans l'habitacle derrière la boîte à gants
- Der filter befindet sich im Fahrgastraum hinter dem Handshuhfach
- El filtro se encuentra en el habitáculo detrás de la guantera

CK 9337

250 x 194 x 20



O/E numbers

Nissan 278939F500 / 278939F500KE

Cross References

Fram CF9337 Mann CU2530
Micronair MP082 Purflux AH225
Tecnocar E424 Fiaam PC8081

--- Primera III ---

02/02 ->

*

*

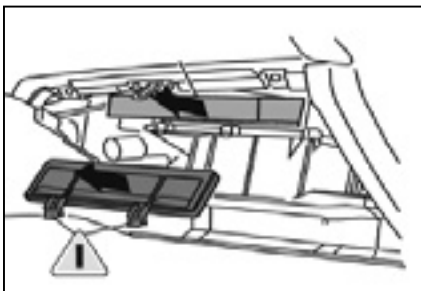

- Il filtro è posizionato nell'abitacolo dietro il vano portaoggetti
- The filter is located in the passenger compartment behind the glove compartment
- Le filtre est situé dans l'habitacle derrière la boîte à gants
- Der filter befindet sich im Fahrgastraum hinter dem Handshuhfach
- El filtro se encuentra en el habitáculo detrás de la guantera

CK 9363

222 x 200 x 30



O/E numbers

Nissan 27891BM401 / 27891BM401KE

Cross References

Fram CF9363 Mann CU2345
Micronair MP063 Purflux AH204
Tecnocar E407 Fiaam PC8083

--- Pulsar ---

10/14 ->

*

*

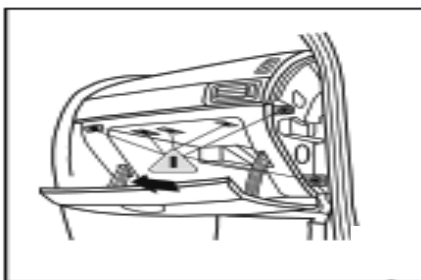

- Il filtro è posizionato nell'abitacolo dietro il vano portaoggetti
- The filter is located in the passenger compartment behind the glove compartment
- Le filtre est situé dans l'habitacle derrière la boîte à gants
- Der filter befindet sich im Fahrgastraum hinter dem Handshuhfach
- El filtro se encuentra en el habitáculo detrás de la guantera

CK 1629

238 x 152 x 32



O/E numbers

Nissan 272771KA0A / 2727700A26

Cross References

Fram CF11119 Mann CU1629
Micronair MP413 Purflux AH306
Tecnocar E708 Fiaam PC8264

CK 1629-C

238 x 152 x 32

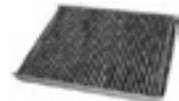

O/E numbers

Nissan 271T200A00

Cross References

Fram CFA11119 Mann CUK1629
Micronair MC913 Purflux AHC309
Tecnocar..... Fiaam PCK8264





Anti-pollen

Activated carbon

NISSAN

--- Qashqai ---

02/07 ->

*

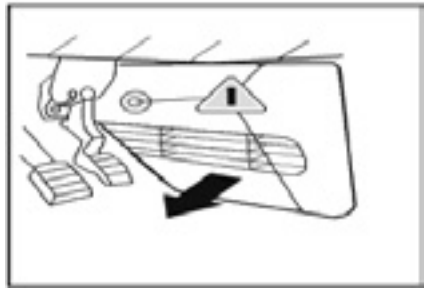

- ① Il filtro è posizionato nell'abitacolo sul lato conducente
- ② The filter is located in the passenger compartment on the driver's side
- ③ Le filtre est situé dans l'habitacle du côté conducteur
- ④ Der Filter befindet sich im Fahrgastraum auf der Fahrerseite
- ⑤ El Filtro se encuentra en el habitáculo, del lado del conductor

CK 1936

263 x 191 x 20



O/E numbers

Nissan 27277EN000 / 27277EN025

Cross References

Fram CF10917 Mann CU1936
Micronair MP270 Purflux AH340
Tecocar E633 Fiaam PC8297

CK 1936-C

263 x 191 x 20



O/E numbers

Nissan 27277JD10A

Cross References

Fram Mann CUK1936
Micronair MC770 Purflux
Tecocar Fiaam

--- Qashqai II ---

02/14 ->

*

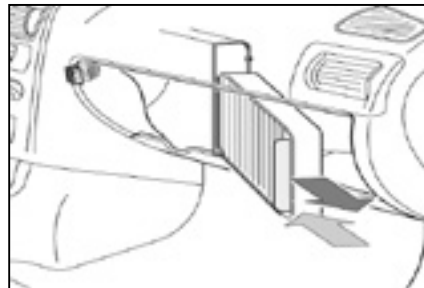

- ① Il filtro è posizionato nell'abitacolo dietro il vano portaoggetti
- ② The filter is located in the passenger compartment behind the glove compartment
- ③ Le filtre est situé dans l'habitacle derrière la boîte à gants
- ④ Der filter befindet sich im Fahrgastraum hinter dem Handschuhfach
- ⑤ El filtro se encuentra en el habitáculo detrás de la guantera

CK 25003

250 x 180 x 35



O/E numbers

Nissan 272774BU0A

Cross References

Fram CF11854 Mann CU25003
Micronair Purflux AH482
Tecocar E724 Fiaam PC8418

--- Sentra ---

08/14 ->

*

*

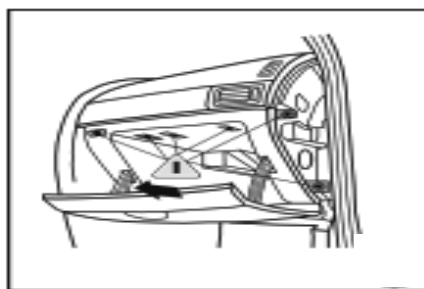

- ① Il filtro è posizionato nell'abitacolo dietro il vano portaoggetti
- ② The filter is located in the passenger compartment behind the glove compartment
- ③ Le filtre est situé dans l'habitacle derrière la boîte à gants
- ④ Der filter befindet sich im Fahrgastraum hinter dem Handschuhfach
- ⑤ El filtro se encuentra en el habitáculo detrás de la guantera

CK 1629

238 x 152 x 32



O/E numbers

Nissan 272771KA0A / 2727700A26

Cross References

Fram CF11119 Mann CU1629
Micronair MP413 Purflux AH306
Tecocar E708 Fiaam PC8264

CK 1629-C

238 x 152 x 32



O/E numbers

Nissan 271T200A00

Cross References

Fram CFA11119 Mann CUK1629
Micronair MC913 Purflux AHC309
Tecocar..... Fiaam PCK8264

--- Teana ---

09/03 -> 02/08

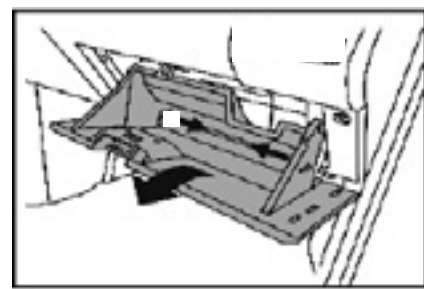

- ① Il filtro è posizionato nell'abitacolo sotto il vano portaoggetti
- ② The filter is located in the passenger compartment under the glove compartment
- ③ Le filtre est situé dans l'habitacle en dessous de la boîte à gants
- ④ Der filter befindet sich im Fahrgastraum unter dem Handschuhfach
- ⑤ El filtro se encuentra en el habitáculo, bajo la guantera en el pasajero

CK 9882

216 x 200 x 30



O/E numbers

Nissan 272774M400 / 27277M425

Cross References

Fram CF9882 Mann CU2252
Micronair..... Purflux AH298
Tecocar E454 Fiaam PC8152

CK 9882-C

216 x 200 x 30



O/E numbers

Nissan 27277Z5000

Cross References

Fram..... Mann CUK2252
Micronair..... Purflux.....
Tecocar..... Fiaam.....

--- Terrano II ---

02/93 -> 06/05

*

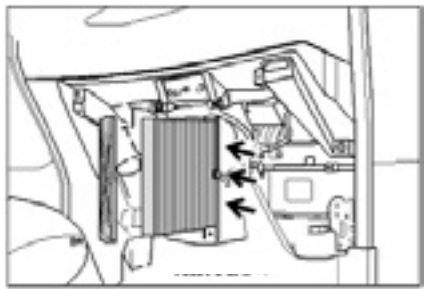

- ① Il filtro è posizionato nell'abitacolo dietro il vano portaoggetti
- ② The filter is located in the passenger compartment behind the glove compartment
- ③ Le filtre est situé dans l'habitacle derrière la boîte à gants
- ④ Der filter befindet sich im Fahrgastraum hinter dem Handschuhfach
- ⑤ El filtro se encuentra en el habitáculo detrás de la guantera

CK 9337

258/250 x 194 x 20



O/E numbers

Nissan 278939F500 / 278939F500KE

Cross References

Fram CF9337 Mann CU2530
Micronair MP082 Purflux AH225
Tecocar E424 Fiaam PC8081



Anti-pollen

Activated carbon

NISSAN

--- Tino ---

02/99 ->

*

*

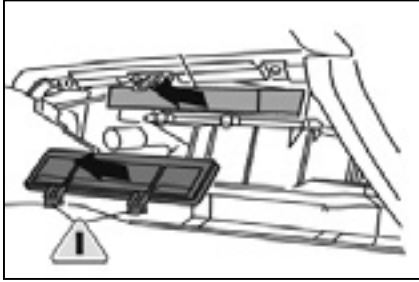

- I** Il filtro è posizionato nell'abitacolo dietro il vano portaoggetti
- GB** The filter is located in the passenger compartment behind the glove compartment
- F** Le filtre est situé dans l'habitacle derrière la boîte à gants
- D** Der filter befindet sich im Fahrgastraum hinter dem Handshuhfach
- E** El filtro se encuentra en el habitáculo detrás de la guantera

CK 9363

222 x 200 x 30



O/E numbers

Nissan 27891BM401 / 27891BM401KE

Cross References

Fram CF9363 Mann CU2345
Micronair MP063 Purflux AH204
Tecocar E407 Fiaam PC8083

--- X-Trail I ---

05/01 -> 06/07

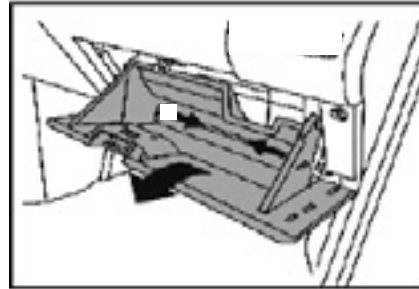

- I** Il filtro è posizionato nell'abitacolo sotto il vano portaoggetti
- GB** The filter is located in the passenger compartment under the glove compartment
- F** Le filtre est situé dans l'habitacle en dessous de la boîte à gants
- D** Der filter befindet sich im Fahrgastraum unter dem Handshuhfach
- E** El filtro se encuentra en el habitáculo, bajo la guantera de pasajerruimte

CK 9882

216 x 200 x 30



O/E numbers

Nissan 272774M400 / 272774M425

Cross References

Fram CF9882 Mann CU2252
Micronair..... Purflux AH298
Tecocar E454 Fiaam PC8152

CK 9882-C

216 x 200 x 30



O/E numbers

Nissan 27277Z5000

Cross References

Fram..... Mann CUK2252
Micronair..... Purflux.....
Tecocar..... Fiaam.....

--- X-Trail II (T31) ---

07/07 ->

*

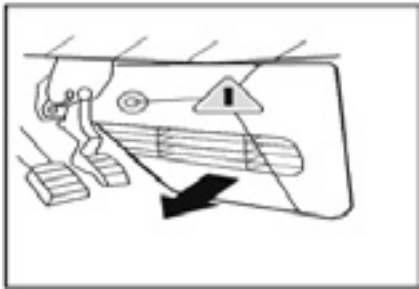

- I** Il filtro è posizionato nell'abitacolo sul lato conducente
- GB** The filter is located in the passenger compartment on the driver's side
- F** Le filtre est situé dans l'habitacle du côté conducteur
- D** Der Filter befindet sich im Fahrgastraum auf der Fahrerseite
- E** El Filtro se encuentra en el habitáculo, del lado del conductor

CK 1936

263 x 191 x 20



O/E numbers

Nissan 27277EN000 / 27277EN025

Cross References

Fram CF10917 Mann CU1936
Micronair MP270 Purflux AH340
Tecocar E633 Fiaam PC8297

CK 1936-C

263 x 191 x 20



O/E numbers

Nissan 27277JD10A

Cross References

Fram Mann CUK1936
Micronair MC770 Purflux
Tecocar Fiaam

--- X-Trail III (T32) ---

04/14 ->

*

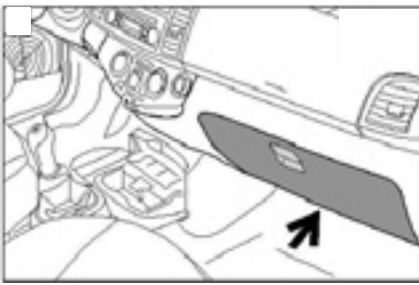

- I** Il filtro è posizionato nell'abitacolo sotto il vano portaoggetti
- GB** The filter is located in the passenger compartment under the glove compartment
- F** Le filtre est situé dans l'habitacle en dessous de la boîte à gants
- D** Der filter befindet sich im Fahrgastraum unter dem Handshuhfach
- E** El filtro se encuentra en el habitáculo, bajo la guantera de pasajerruimte

CK 25012

249 x 180 x 35



O/E numbers

Nissan

Cross References

Fram CF11544 Mann CU25012
Micronair MP427 Purflux AH386
Tecocar E678 Fiaam PC8355

CK 25012-C

249 x 180 x 35



O/E numbers

Nissan

Cross References

Fram CFA11544 Mann CUK25012
Micronair MC927 Purflux AHC386
Tecocar EC678 Fiaam PCK8355











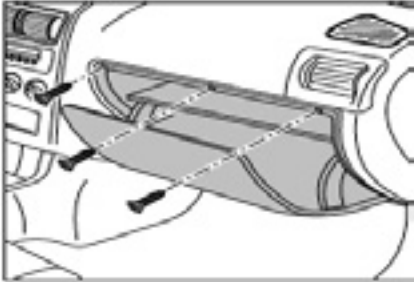

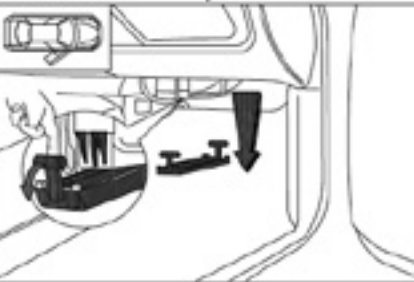

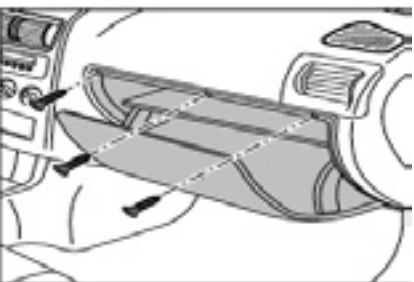
Anti-pollen

Activated carbon

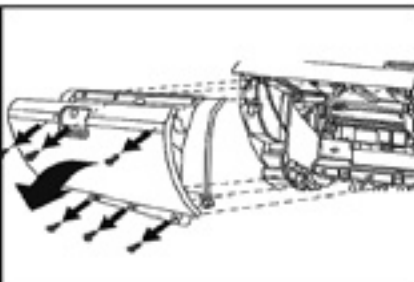
OPEL / VAUXHALL



<p>--- Adam ---</p>  <p> I Il filtro è posizionato nell'abitacolo dietro il vano portaoggetti GB The filter is located in the passenger compartment behind the glove compartment F Le filtre est situé dans l'habitacle derrière la boîte à gants D Der filter befindet sich im Fahrgastraum hinter dem Handschuhfach E El filtro se encuentra en el habitáculo detrás de la guantera </p>	<p>12/12 -> * <input type="checkbox"/></p>	<p>CK 2243 265 x 217 x 20,5</p>  <p><u>O/E numbers</u> Opel 6808622 <u>Cross References</u> Fram CF10282 Mann CU2243 Micronair MP193 Purflux AH244 Tecnicar E465 Fiaam PC8170</p>	<p>CK 2243-C 265 x 217 x 20,5</p>  <p><u>O/E numbers</u> Opel 6808623 <u>Cross References</u> Fram CFA10365 Mann CUK2243 Micronair MC693 Purflux AHC244 Tecnicar EC465 Fiaam PCK8194</p>
<p>--- Agila I ---</p>  <p> I Il filtro è posizionato nell'abitacolo dietro il vano portaoggetti GB The filter is located in the passenger compartment behind the glove compartment F Le filtre est situé dans l'habitacle derrière la boîte à gants D Der filter befindet sich im Fahrgastraum hinter dem Handschuhfach E El filtro se encuentra en el habitáculo detrás de la guantera </p>	<p>09/00 -> 03/08 * <input type="checkbox"/> * <input type="checkbox"/></p>	<p>CK 9335 244 x 207 x 17</p>  <p><u>O/E numbers</u> Opel 4705463 / 09196805 <u>Cross References</u> Fram CF9335 Mann CU2431 Micronair MP077 Purflux AH175 Tecnicar E373 Fiaam PC8079</p>	<p>---</p>
<p>--- Agila II ---</p>  <p> I Il filtro è posizionato nell'abitacolo dietro il vano portaoggetti GB The filter is located in the passenger compartment behind the glove compartment F Le filtre est situé dans l'habitacle derrière la boîte à gants D Der filter befindet sich im Fahrgastraum hinter dem Handschuhfach E El filtro se encuentra en el habitáculo detrás de la guantera </p>	<p>04/08 -> <input type="checkbox"/> <input type="checkbox"/></p>	<p>CK 2028-10 198 x 142 x 29,5</p>  <p><u>O/E numbers</u> Opel 4710210 / 93194847 <u>Cross References</u> Fram CF11244 Mann CU2028 Micronair MP326 Purflux AH343 Tecnicar E636 Fiaam PC8300</p>	<p>---</p>
<p>--- Ampera ---</p>  <p> I Il filtro è posizionato nell'abitacolo dietro il vano portaoggetti GB The filter is located in the passenger compartment behind the glove compartment F Le filtre est situé dans l'habitacle derrière la boîte à gants D Der filter befindet sich im Fahrgastraum hinter dem Handschuhfach E El filtro se encuentra en el habitáculo detrás de la guantera </p>	<p>10/11 -> * <input type="checkbox"/></p>	<p>CK 10774 239 x 204 x 35</p>  <p><u>O/E numbers</u> Chevrolet/Daewoo 13271190 <u>Cross References</u> Fram CF10774 Mann CU2442 Micronair MP366 Purflux AH286 Tecnicar E603 Fiaam PC8255</p>	<p>CK 10774-C 239 x 204 x 35</p>  <p><u>O/E numbers</u> Chevrolet/Daewoo 13271191 <u>Cross References</u> Fram CFA10775 Mann CUK2442 Micronair MC866 Purflux AHC286 Tecnicar EC603 Fiaam PCK8255</p>
<p>--- Antara ---</p>  <p> I Il filtro è posizionato nell'abitacolo dietro il vano portaoggetti GB The filter is located in the passenger compartment behind the glove compartment F Le filtre est situé dans l'habitacle derrière la boîte à gants D Der filter befindet sich im Fahrgastraum hinter dem Handschuhfach E El filtro se encuentra en el habitáculo detrás de la guantera </p>	<p>11/06 -> * <input type="checkbox"/></p>	<p>CK 2622 264 x 198 x 26,5</p>  <p><u>O/E numbers</u> Opel 4803383 <u>Cross References</u> Fram CF11166 Man CU2622 Micronair MP285 Purflux AH307 Tecnicar E656 Fiaam PC8265</p>	<p>CK 2622-C 264 x 198 x 26,5</p>  <p><u>O/E numbers</u> Opel 4819126 <u>Cross References</u> Fram CFA11166 Mann CUK2622 Micronair MC785 Purflux AHC307 Tecnicar EC656 Fiaam PCK8265</p>





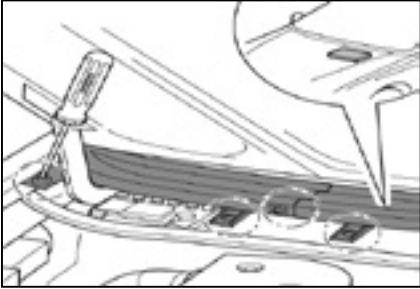

Anti-pollen

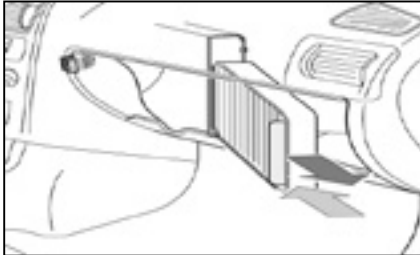

Activated carbon

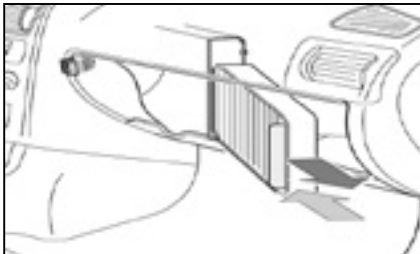

OPEL / VAUXHALL

<p>--- Astra F ---</p> 	09/91 -> 03/01	*	*	<p>CK 5475 429 x 150,5 x 18</p>  <p><u>O/E numbers</u> Opel 1808602 / 6808600 / 93182435</p> <p><u>Cross References</u> Fram CF5475 Mann CU4251 Micronair MP009 Purflux AH106 Tecocar E307 Fiaam PC8002</p>	<p>CK 5475-C 429 x 150,5 x 18</p>  <p><u>O/E numbers</u> Opel 9121625 / 1718044</p> <p><u>Cross References</u> Fram CFA8875 Mann CUK4251 Micronair MC509 Purflux..... Tecocar..... Fiaam PCK8064</p>
	<p>Il filtro è posizionato nel vano motore sul lato passeggero</p> <p>The filter is located in the engine compartment on the passenger's side</p> <p>Le filtre est situé dans le compartiment moteur du côté passager</p> <p>Der filter befindet sich Motorraum auf der Beifahrerseite</p> <p>El filtro se encuentra en el compartimiento del motor, del lado del acompañante</p>				

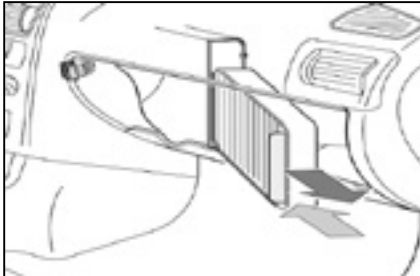
<p>--- Astra G ---</p> <p>With Delphi air conditioning</p> 	02/98 -> 12/09	*	*	<p>CK 8868 295 x 200 x 30</p>  <p><u>O/E numbers</u> Opel 1808610 / 6808606 / 90520689</p> <p><u>Cross References</u> Fram CF8868 Mann CU3054 Micronair MP014 Purflux AH170 Tecocar E366 Fiaam PC8047</p>	<p>CK 8868-C 295 x 200 x 30</p>  <p><u>O/E numbers</u> Opel 1718046 / 13175554 / 6808607</p> <p><u>Cross References</u> Fram CFA8868 Mann CUK3054 Micronair MC514 Purflux..... Tecocar EC366 Fiaam PCK8047</p>
	<p>Il filtro è posizionato nell'abitacolo dietro il vano portaoggetti</p> <p>The filter is located in the passenger compartment behind the glove compartment</p> <p>Le filtre est situé dans l'habitacle derrière la boîte à gants</p> <p>Der filter befindet sich im Fahrgastraum hinter dem Handschuhfach</p> <p>El filtro se encuentra en el habitáculo detrás de la guantera</p>				

<p>--- Astra G ---</p> <p>With Behr air conditioning</p> 	02/98 -> 12/09	*	*	<p>CK 8867 262 x 235 x 30</p>  <p><u>O/E numbers</u> Opel 1808612 / 6808611 / 90559549</p> <p><u>Cross References</u> Fram CF8867 Mann CU2757 Micronair MP047 Purflux AH171 Tecocar E367 Fiaam PC8046</p>	<p>CK 8867-C 262 x 235 x 30</p>  <p><u>O/E numbers</u> Opel 1718042 / 9118699</p> <p><u>Cross References</u> Fram CFA8867 Mann CUK2757 Micronair MC547 Purflux AHC171 Tecocar EC367 Fiaam PCK8046</p>
	<p>Il filtro è posizionato nell'abitacolo dietro il vano portaoggetti</p> <p>The filter is located in the passenger compartment behind the glove compartment</p> <p>Le filtre est situé dans l'habitacle derrière la boîte à gants</p> <p>Der filter befindet sich im Fahrgastraum hinter dem Handschuhfach</p> <p>El filtro se encuentra en el habitáculo detrás de la guantera</p>				

<p>--- Astra H ---</p> 	03/04 ->	*	*	<p>CK 8868 295 x 200 x 30</p>  <p><u>O/E numbers</u> Opel 1808610 / 6808606 / 90520689</p> <p><u>Cross References</u> Fram CF8868 Mann CU3054 Micronair MP014 Purflux AH170 Tecocar E366 Fiaam PC8047</p>	<p>CK 8868-C 295 x 200 x 30</p>  <p><u>O/E numbers</u> Opel 1718046 / 13175554 / 6808607</p> <p><u>Cross References</u> Fram CFA8868 Mann CUK3054 Micronair MC514 Purflux..... Tecocar EC366 Fiaam PCK8047</p>
	<p>Il filtro è posizionato nell'abitacolo dietro il vano portaoggetti</p> <p>The filter is located in the passenger compartment behind the glove compartment</p> <p>Le filtre est situé dans l'habitacle derrière la boîte à gants</p> <p>Der filter befindet sich im Fahrgastraum hinter dem Handschuhfach</p> <p>El filtro se encuentra en el habitáculo detrás de la guantera</p>				



<p>--- Astra J ---</p> 	11/09 ->	*		<p>CK 10774 239 x 204 x 35</p>  <p><u>O/E numbers</u> Opel 1808524</p> <p><u>Cross References</u> Fram CF10774 Mann CU2442 Micronair MP366 Purflux AH286 Tecocar E603 Fiaam PC8255</p>	<p>CK 10774-C 239 x 204 x 35</p>  <p><u>O/E numbers</u> Opel 1808246</p> <p><u>Cross References</u> Fram CFA10775 Mann CUK2442 Micronair MC866 Purflux AHC286 Tecocar EC603 Fiaam PCK8255</p>
	<p>Il filtro è posizionato nell'abitacolo dietro il vano portaoggetti</p> <p>The filter is located in the passenger compartment behind the glove compartment</p> <p>Le filtre est situé dans l'habitacle derrière la boîte à gants</p> <p>Der filter befindet sich im Fahrgastraum hinter dem Handschuhfach</p> <p>El filtro se encuentra en el habitáculo detrás de la guantera</p>				







Anti-pollen

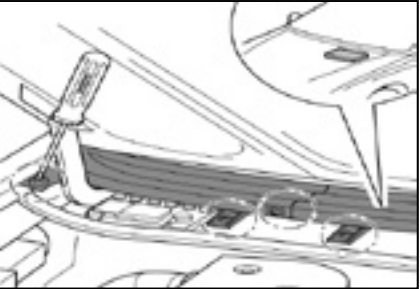

Activated carbon

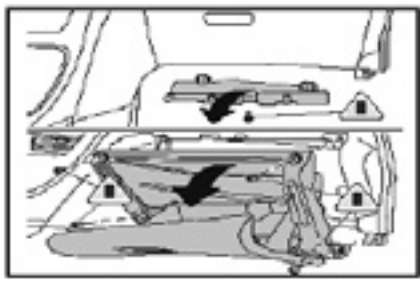

OPEL / VAUXHALL

<p>--- Astra K ---</p>  <p> I Il filtro è posizionato nell'abitacolo dietro il vano portaoggetti GB The filter is located in the passenger compartment behind the glove compartment F Le filtre est situé dans l'habitacle derrière la boîte à gants D Der filter befindet sich im Fahrgastraum hinter dem Handsuhlfach E El filtro se encuentra en el habitáculo detrás de la guantera </p>	<p>08/15 -> * <input type="checkbox"/></p>	<p>CK 24003 240 x 203 x 30</p>  <p><u>O/E numbers</u> Opel</p> <p><u>Cross References</u> Fram Mann Micronair Purflux Tecocar Fiaam</p>	<p>CK 24003-C 240 x 203 x 30</p>  <p><u>O/E numbers</u> Opel 13356914 / 13396514</p> <p><u>Cross References</u> Fram Mann CUK24003 Micronair Purflux Tecocar Fiaam</p>
---	---	--	--

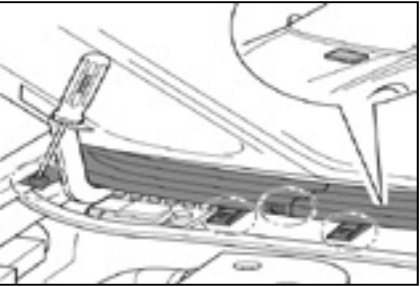
<p>--- Calibra ---</p>  <p> I Il filtro è posizionato nel vano motore sul lato passeggero GB The filter is located in the engine compartment on the passenger's side F Le filtre est situé dans le compartiment moteur du côté passager D Der filter befindet sich Motorraum auf der Beifahrerseite E El filtro se encuentra en el compartimiento del motor, del lado del acompañante </p>	<p>06/90 -> 08/97 * <input type="checkbox"/> * <input type="checkbox"/></p>	<p>CK 5475 429 x 150,5 x 18</p>  <p><u>O/E numbers</u> Opel 1808602 / 6808600 / 93182435</p> <p><u>Cross References</u> Fram CF5475 Mann CU4251 Micronair MP009 Purflux AH106 Tecocar E307 Fiaam PC8002</p>	<p>CK 5475-C 429 x 150,5 x 18</p>  <p><u>O/E numbers</u> Opel 9121625 / 1718044</p> <p><u>Cross References</u> Fram CFA8875 Mann CUK4251 Micronair MC509 Purflux..... Tecocar..... Fiaam PCK8064</p>
---	--	--	--

<p>--- Cascada ---</p>  <p> I Il filtro è posizionato nell'abitacolo dietro il vano portaoggetti GB The filter is located in the passenger compartment behind the glove compartment F Le filtre est situé dans l'habitacle derrière la boîte à gants D Der filter befindet sich im Fahrgastraum hinter dem Handsuhlfach E El filtro se encuentra en el habitáculo detrás de la guantera </p>	<p>02/13 -> * <input type="checkbox"/></p>	<p>CK 10774 239 x 204 x 35</p>  <p><u>O/E numbers</u> Opel 1808524</p> <p><u>Cross References</u> Fram CF10774 Mann CU2442 Micronair MP366 Purflux AH286 Tecocar E603 Fiaam PC8255</p>	<p>CK 10774-C 239 x 204 x 35</p>  <p><u>O/E numbers</u> Opel 1808246</p> <p><u>Cross References</u> Fram CFA10775 Mann CUK2442 Micronair MC866 Purflux AHC286 Tecocar EC603 Fiaam PCK8255</p>
---	---	---	---

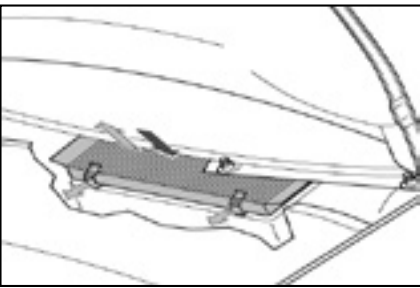
<p>--- Combo A ---</p>  <p> I Il filtro è posizionato nel vano motore sul lato passeggero GB The filter is located in the engine compartment on the passenger's side F Le filtre est situé dans le compartiment moteur du côté passager D Der filter befindet sich Motorraum auf der Beifahrerseite E El filtro se encuentra en el compartimiento del motor, del lado del acompañante </p>	<p>07/94 -> 10/01 * <input type="checkbox"/></p>	<p>CK 5475 429 x 150,5 x 18</p>  <p><u>O/E numbers</u> Opel 1808602 / 6808600 / 93182435</p> <p><u>Cross References</u> Fram CF5475 Mann CU4251 Micronair MP009 Purflux AH106 Tecocar E307 Fiaam PC8002</p>	<p>CK 5475-C 429 x 150,5 x 18</p>  <p><u>O/E numbers</u> Opel 9121625 / 1718044</p> <p><u>Cross References</u> Fram CFA8875 Mann CUK4251 Micronair MC509 Purflux..... Tecocar..... Fiaam PCK8064</p>
---	---	--	--

<p>--- Combo A ---</p>  <p> I Il filtro è posizionato nel vano motore al centro GB The filter is located in the engine compartment centrally F Le filtre est situé dans le compartiment moteur au centre D Der Filter befindet sich im Motorraum mitting E El filtro se encuentra en el compartimiento del motor, en el centro </p>	<p>07/94 -> 10/01 <input type="checkbox"/> * <input type="checkbox"/></p>	<p>CK 5665 335/325 x 197/187 x 17,5</p>  <p><u>O/E numbers</u> Opel 90509367 / 1808604 / 6806612</p> <p><u>Cross References</u> Fram CF5665 Mann CU3455 Micronair MP018 Purflux AH105 Tecocar E310 Fiaam PC8007</p>	<p>CK 5665-C 335/325 x 197/187 x 17,5</p>  <p><u>O/E numbers</u> Opel 9121626 / 1718045 / 91132360</p> <p><u>Cross References</u> Fram CFA8880 Mann CUK3455 Micronair MC518 Purflux AHC105 Tecocar EC310 Fiaam PCK8069</p>
--	--	--	--



Anti-pollen

Activated carbon

OPEL / VAUXHALL

--- Combo B ---

10/01 ->

*

*

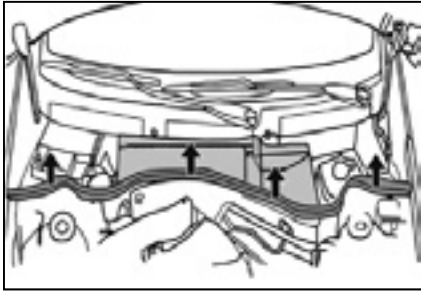

- I** Il filtro è posizionato nel vano motore al centro
- GB** The filter is located in the engine compartment centrally
- F** Le filtre est situé dans le compartiment moteur au centre
- D** Der Filter befindet sich im Motorraum mitting
- E** El filtro se encuentra en el compartimiento del motor, en el centro

CK 9495

332 x 164 x 30



O/E numbers

Opel 1808619 / 6808601

Cross References

Fram CF9495/CF9531 Mann CU3337
 Micronair MP107 Purflux AH198
 Tecocar E400 Fiaam PC8097

CK 9495-C

332 x 164 x 30



O/E numbers

Opel 1808617 / 1808624

Cross References

Fram CFA9495 Mann CUK3337
 Micronair MC607/MC694 Purflux AHC198
 Tecocar EC400 Fiaam PCK8097

--- Combo D --- Left-hand drive

02/12 ->

*

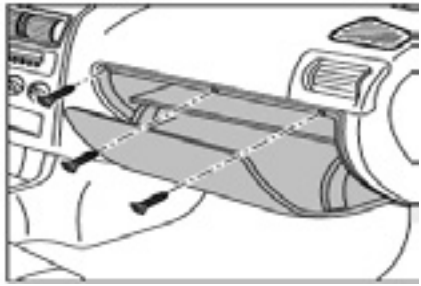

- I** Il filtro è posizionato nell'abitacolo dietro il vano portaoggetti
- GB** The filter is located in the passenger compartment behind the glove compartment
- F** Le filtre est situé dans l'habitacle derrière la boîte à gants
- D** Der filter befindet sich im Fahrgastraum hinter dem Handsuhfach
- E** El filtro se encuentra en el habitáculo detrás de la guantera

CK 10413-10

199 x 177,5 x 30



O/E numbers

Opel 1808029 / 95514195

Cross References

Fram CF10413 Mann CU2040
 Micronair MP283 Purflux AH265
 Tecocar Fiaam PC8200

--- Combo D --- Right-hand drive

02/12 ->

*

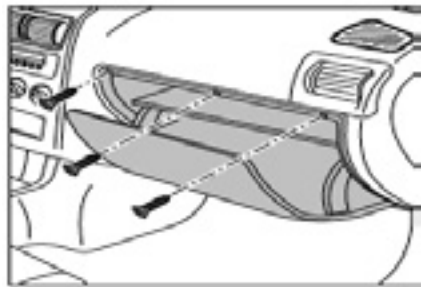

- I** Il filtro è posizionato nell'abitacolo dietro il vano portaoggetti
- GB** The filter is located in the passenger compartment behind the glove compartment
- F** Le filtre est situé dans l'habitacle derrière la boîte à gants
- D** Der filter befindet sich im Fahrgastraum hinter dem Handsuhfach
- E** El filtro se encuentra en el habitáculo detrás de la guantera

CK 2243

265 x 217 x 20,5



O/E numbers

Opel 6808622

Cross References

Fram CF10282 Mann CU2243
 Micronair MP193 Purflux AH244
 Tecocar E465 Fiaam PC8170

CK 2243-C

265 x 217 x 20,5



O/E numbers

Opel 6808623

Cross References

Fram CFA10365 Mann CUK2243
 Micronair MC693 Purflux AHC244
 Tecocar EC465 Fiaam PCK8194

--- Corsa B ---

03/93 -> 08/01

*

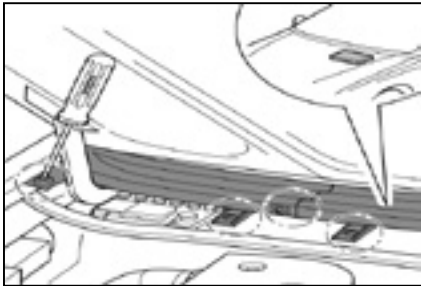

- I** Il filtro è posizionato nel vano motore sul lato passeggero
- GB** The filter is located in the engine compartment on the passenger's side
- F** Le filtre est situé dans le compartiment moteur du côté passager
- D** Der filter befindet sich Motorraum auf der Beifahrerseite
- E** El filtro se encuentra en el compartimiento del motor, del lado del acompañante

CK 5475

429 x 150,5 x 18



O/E numbers

Opel 1808602 / 6808600 / 93182435

Cross References

Fram CF5475 Mann CU4251
 Micronair MP009 Purflux AH106
 Tecocar E307 Fiaam PC8002

CK 5475-C

429 x 150,5 x 18



O/E numbers

Opel 9121625 / 1718044

Cross References

Fram CFA8875 Mann CUK4251
 Micronair MC509 Purflux.....
 Tecocar..... Fiaam PCK8064

--- Corsa B ---

03/93 -> 08/01

*

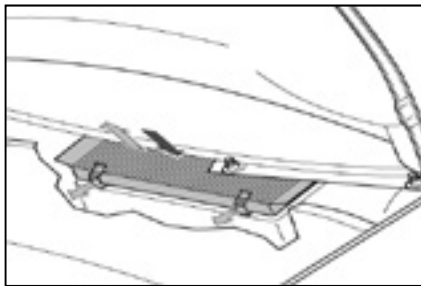

- I** Il filtro è posizionato nel vano motore al centro
- GB** The filter is located in the engine compartment centrally
- F** Le filtre est situé dans le compartiment moteur au centre
- D** Der Filter befindet sich im Motorraum mitting
- E** El filtro se encuentra en el compartimiento del motor, en el centro

CK 5665

335/325 x 197/187 x 17,5



O/E numbers

Opel 90509367 / 1808604 / 6806612

Cross References

Fram CF5665 Mann CU3455
 Micronair MP018 Purflux AH105
 Tecocar E310 Fiaam PC8007

CK 5665-C

335/325 x 197/187 x 17,5



O/E numbers

Opel 9121626 / 1718045 / 91132360

Cross References

Fram CFA8880 Mann CUK3455
 Micronair MC518 Purflux AHC105
 Tecocar EC310 Fiaam PCK8069





Anti-pollen

Activated carbon

OPEL / VAUXHALL

<p>--- Corsa C ---</p>	09/00 -> 06/07	*	*	<p>CK 9495 332 x 164 x 30</p> <p><u>O/E numbers</u> Opel 1808619 / 6808601</p> <p><u>Cross References</u> Fram CF9495/CF9531 Mann CU3337 Micronair MP107 Purflux AH198 Tecocar E400 Fiaam PC8097</p>	<p>CK 9495-C 332 x 164 x 30</p> <p><u>O/E numbers</u> Opel 1808617 / 1808624</p> <p><u>Cross References</u> Fram CFA9495 Mann CUK3337 Micronair MC607/MC694 Purflux AHC198 Tecocar EC400 Fiaam PCK8097</p>
	<p>Il filtro è posizionato nel vano motore al centro</p> <p>The filter is located in the engine compartment centrally</p> <p>Le filtre est situé dans le compartiment moteur au centre</p> <p>Der Filter befindet sich im Motorraum mittig</p> <p>El filtro se encuentra en el compartimiento del motor, en el centro</p>				

<p>--- Corsa D ---</p>	09/06 ->	*		<p>CK 2243 265 x 217 x 20,5</p> <p><u>O/E numbers</u> Opel 6808622</p> <p><u>Cross References</u> Fram CF10282 Mann CU2243 Micronair MP193 Purflux AH244 Tecocar E465 Fiaam PC8170</p>	<p>CK 2243-C 265 x 217 x 20,5</p> <p><u>O/E numbers</u> Opel 6808623</p> <p><u>Cross References</u> Fram CFA10365 Mann CUK2243 Micronair MC693 Purflux AHC244 Tecocar EC465 Fiaam PCK8194</p>
	<p>Il filtro è posizionato nell'abitacolo dietro il vano portaoggetti</p> <p>The filter is located in the passenger compartment behind the glove compartment</p> <p>Le filtre est situé dans l'habitacle derrière la boîte à gants</p> <p>Der filter befindet sich im Fahrgastraum hinter dem Handshuhfach</p> <p>El filtro se encuentra en el habitáculo detrás de la guantera</p>				

<p>--- Corsa E ---</p>	09/14 ->	*		<p>CK 2243 265 x 217 x 20,5</p> <p><u>O/E numbers</u> Opel 6808622</p> <p><u>Cross References</u> Fram CF10282 Mann CU2243 Micronair MP193 Purflux AH244 Tecocar E465 Fiaam PC8170</p>	<p>CK 2243-C 265 x 217 x 20,5</p> <p><u>O/E numbers</u> Opel 6808623</p> <p><u>Cross References</u> Fram CFA10365 Mann CUK2243 Micronair MC693 Purflux AHC244 Tecocar EC465 Fiaam PCK8194</p>
	<p>Il filtro è posizionato nell'abitacolo dietro il vano portaoggetti</p> <p>The filter is located in the passenger compartment behind the glove compartment</p> <p>Le filtre est situé dans l'habitacle derrière la boîte à gants</p> <p>Der filter befindet sich im Fahrgastraum hinter dem Handshuhfach</p> <p>El filtro se encuentra en el habitáculo detrás de la guantera</p>				

<p>--- Insignia ---</p>	11/08 ->	*		<p>CK 10774 239 x 204 x 35</p> <p><u>O/E numbers</u> Opel 1808524</p> <p><u>Cross References</u> Fram CF10774 Mann CU2442 Micronair MP366 Purflux AH286 Tecocar E603 Fiaam PC8255</p>	<p>CK 10774-C 239 x 204 x 35</p> <p><u>O/E numbers</u> Opel 1808246</p> <p><u>Cross References</u> Fram CFA10775 Mann CUK2442 Micronair MC866 Purflux AHC286 Tecocar EC603 Fiaam PCK8255</p>
	<p>Il filtro è posizionato nell'abitacolo dietro il vano portaoggetti</p> <p>The filter is located in the passenger compartment behind the glove compartment</p> <p>Le filtre est situé dans l'habitacle derrière la boîte à gants</p> <p>Der filter befindet sich im Fahrgastraum hinter dem Handshuhfach</p> <p>El filtro se encuentra en el habitáculo detrás de la guantera</p>				

<p>--- Karl ---</p>	05/15 ->	*		<p>CK 10774 239 x 204 x 35</p> <p><u>O/E numbers</u> Opel 1808524</p> <p><u>Cross References</u> Fram CF10774 Mann CU2442 Micronair MP366 Purflux AH286 Tecocar E603 Fiaam PC8255</p>	<p>CK 10774-C 239 x 204 x 35</p> <p><u>O/E numbers</u> Opel 1808246</p> <p><u>Cross References</u> Fram CFA10775 Mann CUK2442 Micronair MC866 Purflux AHC286 Tecocar EC603 Fiaam PCK8255</p>
	<p>Il filtro è posizionato nell'abitacolo dietro il vano portaoggetti</p> <p>The filter is located in the passenger compartment behind the glove compartment</p> <p>Le filtre est situé dans l'habitacle derrière la boîte à gants</p> <p>Der filter befindet sich im Fahrgastraum hinter dem Handshuhfach</p> <p>El filtro se encuentra en el habitáculo detrás de la guantera</p>				



Anti-pollen

Activated carbon

OPEL / VAUXHALL

--- Meriva A ---

02/03 -> 05/10

*

*

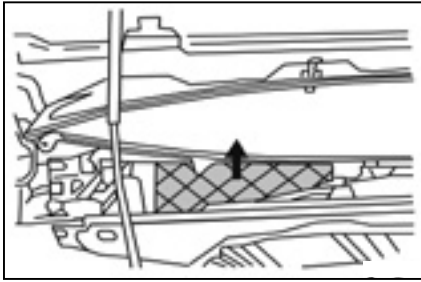

- I** Il filtro è posizionato nel vano motore al centro
- GB** The filter is located in the engine compartment centrally
- F** Le filtre est situé dans le compartiment moteur au centre
- D** Der Filter befindet sich im Motorraum mittig
- E** El filtro se encuentra en el compartimiento del motor, en el centro

CK 9904

239,5 x 209 x 31,5



O/E numbers

Opel 6808604 / 93174800

Cross References

Fram CF9904 Mann CU2143
 Micronair MP139 Purflux AH206
 Tecocar E410 Fiaam PC8151

CK 9904-C

239,5 x 209 x 31,5



O/E numbers

Opel 6808605 / 93174801

Cross References

Fram CFA9904 Mann CUK2143
 Micronair MC639 Purflux AHC206
 Tecocar EC410 Fiaam PCK8151

--- Meriva B ---

-> chassis C4999999

05/10 -> 06/12

*

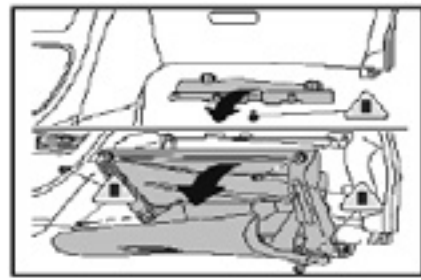

- I** Il filtro è posizionato nell'abitacolo dietro il vano portaoggetti
- GB** The filter is located in the passenger compartment behind the glove compartment
- F** Le filtre est situé dans l'habitacle derrière la boîte à gants
- D** Der filter befindet sich im Fahrgastraum hinter dem Handshuhfach
- E** El filtro se encuentra en el habitáculo detrás de la guantera

CK 10774

239 x 204 x 35



O/E numbers

Opel 1808524

Cross References

Fram CF10774 Mann CU2442
 Micronair MP366 Purflux AH286
 Tecocar E603 Fiaam PC8255

CK 10774-C

239 x 204 x 35



O/E numbers

Opel 1808246

Cross References

Fram CFA10775 Mann CUK2442
 Micronair MC866 Purflux AHC286
 Tecocar EC603 Fiaam PCK8255

--- Meriva B ---

-> chassis C4999999

07/12 ->

*

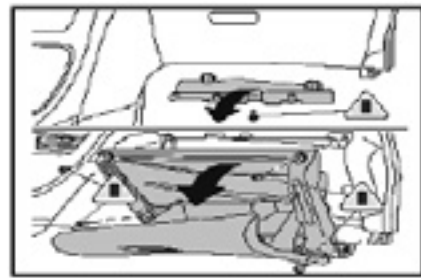

- I** Il filtro è posizionato nell'abitacolo dietro il vano portaoggetti
- GB** The filter is located in the passenger compartment behind the glove compartment
- F** Le filtre est situé dans l'habitacle derrière la boîte à gants
- D** Der filter befindet sich im Fahrgastraum hinter dem Handshuhfach
- E** El filtro se encuentra en el habitáculo detrás de la guantera

CK 24003

240 x 203 x 30



O/E numbers

Opel

Cross References

Fram Mann
 Micronair Purflux
 Tecocar Fiaam

CK 24003-C

240 x 203 x 30



O/E numbers

Opel 13356914 / 13396514

Cross References

Fram Mann CUK24003
 Micronair Purflux
 Tecocar Fiaam

--- Mokka ---

09/12 ->

*



- I** Il filtro è posizionato nell'abitacolo dietro il vano portaoggetti
- GB** The filter is located in the passenger compartment behind the glove compartment
- F** Le filtre est situé dans l'habitacle derrière la boîte à gants
- D** Der filter befindet sich im Fahrgastraum hinter dem Handshuhfach
- E** El filtro se encuentra en el habitáculo detrás de la guantera

CK 10774

239 x 204 x 35



O/E numbers

Opel 1808524

Cross References

Fram CF10774 Mann CU2442
 Micronair MP366 Purflux AH286
 Tecocar E603 Fiaam PC8255

CK 10774-C

239 x 204 x 35



O/E numbers

Opel 1808246

Cross References

Fram CFA10775 Mann CUK2442
 Micronair MC866 Purflux AHC286
 Tecocar EC603 Fiaam PCK8255

--- Movano B ---

04/10 ->



- I** Il filtro è posizionato nell'abitacolo dietro il vano portaoggetti
- GB** The filter is located in the passenger compartment behind the glove compartment
- F** Le filtre est situé dans l'habitacle derrière la boîte à gants
- D** Der filter befindet sich im Fahrgastraum hinter dem Handshuhfach
- E** El filtro se encuentra en el habitáculo detrás de la guantera

CK 10534-2

239 x 108 x 20



O/E numbers

Opel 4419683

Cross References

Fram CF10534-2 Mann CU2418-2
 Micronair MP276-2 Purflux AH273
 Tecocar E487-2 Fiaam PC8217-2

CK 10534-C-2

239 x 108 x 20

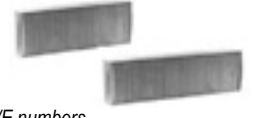

O/E numbers

Opel.....

Cross References

Fram..... Mann.....
 Micronair..... Purflux AHC273
 Tecocar..... Fiaam.....



Anno di fabbricazione / Year of construction
 Anné de fabrication / Baujahr / Año de fabricaci6n



Con climatizzatore / With air-conditioning / Avec climatisation
 Mit Klimaanlage / Con instalaci6n de aire acondicionado



Senza climatizzatore / Without air-conditioning / Sans climatisation
 Ohne Klimaanlage / Sin instalaci6n de aire acondicionado



Anti-pollen

Activated carbon

OPEL / VAUXHALL

--- Omega B ---

04/94 -> 08/99

*

*

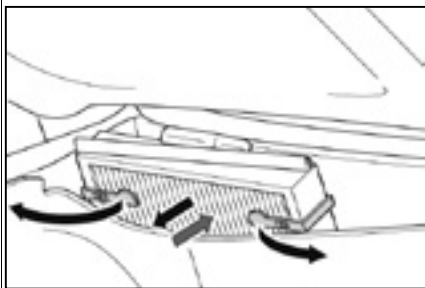

- I** Il filtro è posizionato nel vano motore
- GB** The filter is located in the engine compartment
- F** Le filtre est situé dans le compartiment moteur
- D** Der Filter befindet sich im Motorraum
- E** El filtro se encuentra en el compartimiento del motor

CK 5816

290 x 224 x 17



O/E numbers

Opel 1808605 / 6808613 / 93182438

Cross References

Fram CF5816 Mann CU3059
Micronair MP015 Purflux AH128
Tecnocar E346 Fiaam PC8010

CK 5816-C

290 x 224 x 17



O/E numbers

Opel 1718022 / 631916 / 9121624

Cross References

Fram CFA8874 Mann CUK3059
Micronair MC515 Purflux AHC128
Tecnocar EC346 FiaamPCK8104/PCK8073

--- Signum ---

04/03 -> 10/09

*

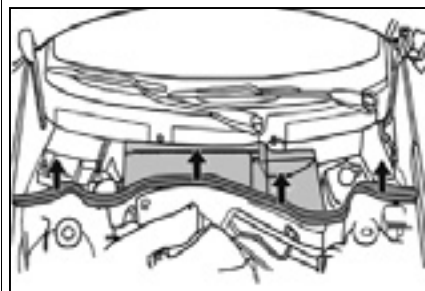

- I** Il filtro è posizionato nel vano motore al centro
- GB** The filter is located in the engine compartment centrally
- F** Le filtre est situé dans le compartiment moteur au centre
- D** Der Filter befindet sich im Motorraum mitting
- E** El filtro se encuentra en el compartimiento del motor, en el centro

CK 9495

332 x 164 x 30



O/E numbers

Opel 1808619 / 6808601

Cross References

Fram CF9495/CF9531 Mann CU3337
Micronair MP107 Purflux AH198
Tecnocar E400 Fiaam PC8097

CK 9495-C

332 x 164 x 30



O/E numbers

Opel 1808617 / 1808624

Cross References

Fram CFA9495 Mann CUK3337
Micronair MC607/MC694 Purflux AHC198
Tecnocar EC400 Fiaam PCK8097

--- Sintra ---

11/96 -> 06/99

*

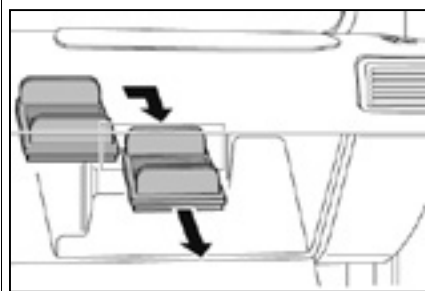

- I** Il filtro è posizionato nell'abitacolo dietro il vano portaoggetti
- GB** The filter is located in the passenger compartment behind the glove compartment
- F** Le filtre est situé dans l'habitacle derrière la boîte à gants
- D** Der filter befindet sich im Fahrgastraum hinter dem Handsuhfach
- E** El filtro se encuentra en el habitáculo detrás de la guantera

CK 8914-2

226 x 113 x 30/57



O/E numbers

Opel 09121653 / 1718962

Cross References

Fram CF8914 Mann CU2224-2
Micronair MP058-2 Purflux AH157
Tecnocar E356 Fiaam PC8052

--- Tigra ---

07/94 -> 12/00

*

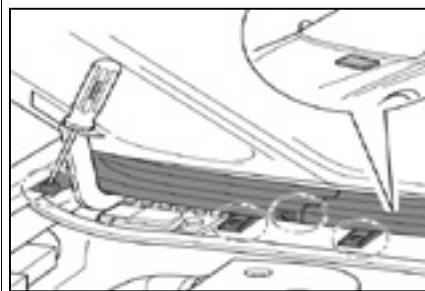

- I** Il filtro è posizionato nel vano motore sul lato passeggero
- GB** The filter is located in the engine compartment on the passenger's side
- F** Le filtre est situé dans le compartiment moteur du côté passager
- D** Der filter befindet sich im Motorraum auf der Beifahrerseite
- E** El filtro se encuentra en el compartimiento del motor, del lado del acompañante

CK 5475

429 x 150,5 x 18



O/E numbers

Opel 1808602 / 6808600 / 93182435

Cross References

Fram CF5475 Mann CU4251
Micronair MP009 Purflux AH106
Tecnocar E307 Fiaam PC8002

CK 5475-C

429 x 150,5 x 18



O/E numbers

Opel 9121625 / 1718044

Cross References

Fram CFA8875 Mann CUK4251
Micronair MC509 Purflux.....
Tecnocar..... Fiaam PCK8064

--- Tigra ---

07/94 -> 12/00

*

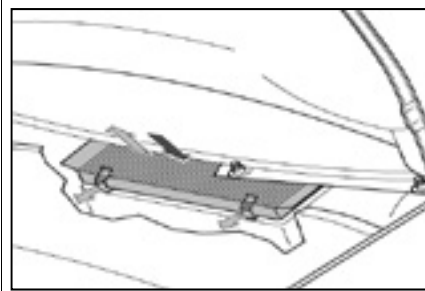

- I** Il filtro è posizionato nel vano motore al centro
- GB** The filter is located in the engine compartment centrally
- F** Le filtre est situé dans le compartiment moteur au centre
- D** Der Filter befindet sich im Motorraum mitting
- E** El filtro se encuentra en el compartimiento del motor, en el centro

CK 5665

335/325 x 197/187 x 17,5



O/E numbers

Opel 90509367 / 1808604 / 6806612

Cross References

Fram CF5665 Mann CU3455
Micronair MP018 Purflux AH105
Tecnocar E310 Fiaam PC8007

CK 5665-C

335/325 x 197/187 x 17,5



O/E numbers

Opel 9121626 / 1718045 / 91132360

Cross References

Fram CFA8880 Mann CUK3455
Micronair MC518 Purflux AHC105
Tecnocar EC310 Fiaam PCK8069



Anti-pollen

Activated carbon

OPEL / VAUXHALL

--- Tigra Twin Top ---

07/04 -> 10/09

*

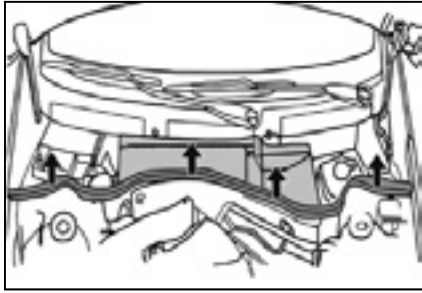

- I** Il filtro è posizionato nel vano motore al centro
- GB** The filter is located in the engine compartment centrally
- F** Le filtre est situé dans le compartiment moteur au centre
- D** Der Filter befindet sich im Motorraum mittig
- E** El filtro se encuentra en el compartimiento del motor, en el centro

CK 9495

332 x 164 x 30



O/E numbers

Opel 1808619 / 6808601

Cross References

Fram CF9495/CF9531 Mann CU3337
Micronair MP107 Purflux AH198
Tecocar E400 Fiaam PC8097

CK 9495-C

332 x 164 x 30



O/E numbers

Opel 1808617 / 1808624

Cross References

Fram CFA9495 Mann CUK3337
Micronair MC607/MC694 Purflux AHC198
Tecocar EC400 Fiaam PCK8097

--- Vectra B ---

10/95 -> 09/02

*

*

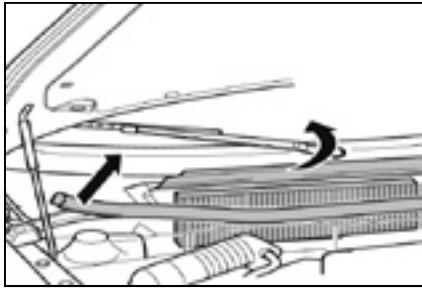

- I** Il filtro è posizionato nel vano motore sul lato passeggero
- GB** The filter is located in the engine compartment on the passenger's side
- F** Le filtre est situé dans le compartiment moteur du côté passager
- D** Der filter befindet sich Motorraum auf der Beifahrerseite
- E** El filtro se encuentra en el compartimiento del motor, del lado del acompañante

CK 5863

412 x 145 x 24



O/E numbers

Opel 1808607 / 90512779

Cross References

Fram CF5863 Mann CU4151
Micronair MP032 Purflux AH124
Tecocar E325 Fiaam PC8028

CK 5863-C

417/412 x 141 x 25



O/E numbers

Opel 1808608 / 9054317/911323367

Cross References

Fram CFA8879 Mann CUK4151
Micronair MC532 Purflux AHC124
Tecocar..... Fiaam PCK8067

--- Vectra C ---

03/02 ->

*

*

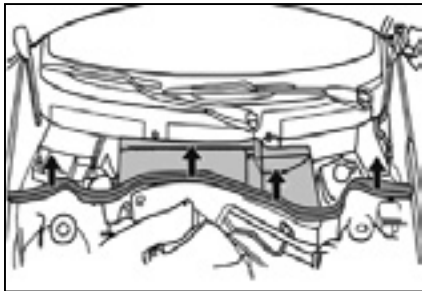

- I** Il filtro è posizionato nel vano motore al centro
- GB** The filter is located in the engine compartment centrally
- F** Le filtre est situé dans le compartiment moteur au centre
- D** Der Filter befindet sich im Motorraum mittig
- E** El filtro se encuentra en el compartimiento del motor, en el centro

CK 9495

332 x 164 x 30



O/E numbers

Opel 1808619 / 6808601

Cross References

Fram CF9495/CF9531 Mann CU3337
Micronair MP107 Purflux AH198
Tecocar E400 Fiaam PC8097

CK 9495-C

332 x 164 x 30



O/E numbers

Opel 1808617 / 1808624

Cross References

Fram CFA9495 Mann CUK3337
Micronair MC607/MC694 Purflux AHC198
Tecocar EC400 Fiaam PCK8097

--- Vivaro A ---

03/01 ->

*

*



- I** Il filtro è posizionato nel vano motore
- GB** The filter is located in the engine compartment
- F** Le filtre est situé dans le compartiment moteur
- D** Der Filter befindet sich im Motorraum
- E** El filtro se encuentra en el compartimiento del motor

CK 9934

336 x 191/180 x 30/45



O/E numbers

Opel 91160128 / 4408840

Cross References

Fram CF9934 Mann CU3454
Micronair MP223 Purflux AH186
Tecocar E389 Fiaam PC8154

--- Vivaro B ---

07/14 ->



- I** Il filtro è posizionato nell'abitacolo dietro il vano portaoggetti
- GB** The filter is located in the passenger compartment behind the glove compartment
- F** Le filtre est situé dans l'habitacle derrière la boîte à gants
- D** Der filter befindet sich im Fahrgastraum hinter dem Handsuhfach
- E** El filtro se encuentra en el habitáculo detrás de la guantera

CK 27001-C

263 x 196 x 38



O/E numbers

Opel 4407080

Cross References



Fram CFA10761 Mann CUK27001
Micronair MC907 Purflux AHC284
Tecocar EC601 Fiaam PCK8253





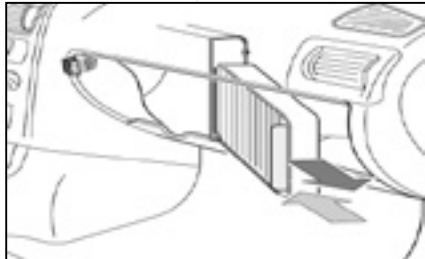

Anti-pollen

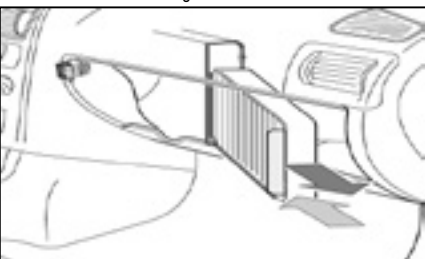

Activated carbon

OPEL / VAUXHALL

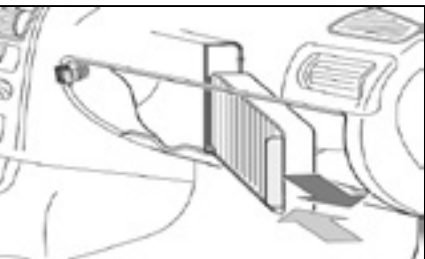
<p>--- Zafira A ---</p> <p>With Delphi air conditioning</p> 	02/99 -> 07/05	*		<p>CK 8868</p> <p>295 x 200 x 30</p>  <p><u>O/E numbers</u> Opel 1808610 / 6808606 / 90520689</p> <p><u>Cross References</u> Fram CF8868 Mann CU3054 Micronair MP014 Purflux AH170 Tecocar E366 Fiaam PC8047</p>	<p>CK 8868-C</p> <p>295 x 200 x 30</p>  <p><u>O/E numbers</u> Opel 1718046 / 13175554 / 6808607</p> <p><u>Cross References</u> Fram CFA8868 Mann CUK3054 Micronair MC514 Purflux..... Tecocar EC366 Fiaam PCK8047</p>
	<p>Il filtro è posizionato nell'abitacolo dietro il vano portaoggetti</p> <p>The filter is located in the passenger compartment behind the glove compartment</p> <p>Le filtre est situé dans l'habitacle derrière la boîte à gants</p> <p>Der filter befindet sich im Fahrgastraum hinter dem Handschuhfach</p> <p>El filtro se encuentra en el habitáculo detrás de la guantera</p>				

<p>--- Zafira A ---</p> <p>With Behr air conditioning</p> 	02/99 -> 07/05	*		<p>CK 8867</p> <p>262 x 235 x 30</p>  <p><u>O/E numbers</u> Opel 1808612 / 6808611 / 90559549</p> <p><u>Cross References</u> Fram CF8867 Mann CU2757 Micronair MP047 Purflux AH171 Tecocar E367 Fiaam PC8046</p>	<p>CK 8867-C</p> <p>262 x 235 x 30</p>  <p><u>O/E numbers</u> Opel 1718042 / 9118699</p> <p><u>Cross References</u> Fram CFA8867 Mann CUK2757 Micronair MC547 Purflux AHC171 Tecocar EC367 Fiaam PCK8046</p>
	<p>Il filtro è posizionato nell'abitacolo dietro il vano portaoggetti</p> <p>The filter is located in the passenger compartment behind the glove compartment</p> <p>Le filtre est situé dans l'habitacle derrière la boîte à gants</p> <p>Der filter befindet sich im Fahrgastraum hinter dem Handschuhfach</p> <p>El filtro se encuentra en el habitáculo detrás de la guantera</p>				

<p>--- Zafira B ---</p> 	07/05 ->	*		<p>CK 8867</p> <p>262 x 235 x 30</p>  <p><u>O/E numbers</u> Opel 1808612 / 6808611 / 90559549</p> <p><u>Cross References</u> Fram CF8867 Mann CU2757 Micronair MP047 Purflux AH171 Tecocar E367 Fiaam PC8046</p>	<p>CK 8867-C</p> <p>262 x 235 x 30</p>  <p><u>O/E numbers</u> Opel 1718042 / 9118699</p> <p><u>Cross References</u> Fram CFA8867 Mann CUK2757 Micronair MC547 Purflux AHC171 Tecocar EC367 Fiaam PCK8046</p>
	<p>Il filtro è posizionato nell'abitacolo dietro il vano portaoggetti</p> <p>The filter is located in the passenger compartment behind the glove compartment</p> <p>Le filtre est situé dans l'habitacle derrière la boîte à gants</p> <p>Der filter befindet sich im Fahrgastraum hinter dem Handschuhfach</p> <p>El filtro se encuentra en el habitáculo detrás de la guantera</p>				

<p>--- Zafira Tourer / Zafira C ---</p> 	10/11 ->	*		<p>CK 10774</p> <p>239 x 204 x 35</p>  <p><u>O/E numbers</u> Opel 1808524</p> <p><u>Cross References</u> Fram CF10774 Mann CU2442 Micronair MP366 Purflux AH286 Tecocar E603 Fiaam PC8255</p>	<p>CK 10774-C</p> <p>239 x 204 x 35</p>  <p><u>O/E numbers</u> Opel 1808246</p> <p><u>Cross References</u> Fram CFA10775 Mann CUK2442 Micronair MC866 Purflux AHC286 Tecocar EC603 Fiaam PCK8255</p>
	<p>Il filtro è posizionato nell'abitacolo dietro il vano portaoggetti</p> <p>The filter is located in the passenger compartment behind the glove compartment</p> <p>Le filtre est situé dans l'habitacle derrière la boîte à gants</p> <p>Der filter befindet sich im Fahrgastraum hinter dem Handschuhfach</p> <p>El filtro se encuentra en el habitáculo detrás de la guantera</p>				

--	--	--	--







Anti-pollen

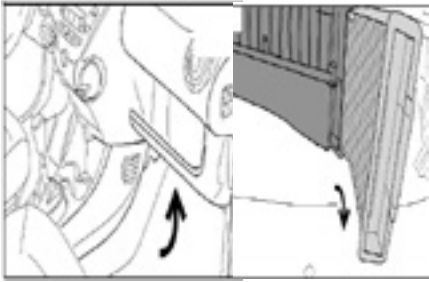

Activated carbon

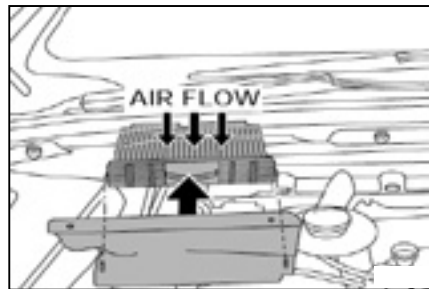

PEUGEOT

--- 107 ---	06/05 ->	*	*	<p>CK 207 225/215 x 164/150,5 x 44</p>  <p><u>O/E numbers</u> Peugeot 6479A5 - 6447TT</p> <p><u>Cross References</u> Fram CF10080 Mann CU2317 Micronair MP207 Purflux AH223 Tecocar E440 Fiaam PC8243</p>	---
 <ul style="list-style-type: none"> I Il filtro è posizionato nell'abitacolo dietro il vano portaoggetti GB The filter is located in the passenger compartment behind the glove compartment F Le filtre est situé dans l'habitacle derrière la boîte à gants D Der filter befindet sich im Fahrgastraum hinter dem Handshuhfach E El filtro se encuentra en el habitáculo detrás de la guantera 					

--- 1007 ---	04/05 ->	*		<p>CK 9398 284 x 175 x 36</p>  <p><u>O/E numbers</u> Peugeot 6447KK</p> <p><u>Cross References</u> Fram CF9398 Mann CU2940 Micronair MP071 Purflux AH179 Tecocar E382 Fiaam PC8088</p>	<p>CK 9398-C 284 x 175 x 36</p>  <p><u>O/E numbers</u> Peugeot 6447KL</p> <p><u>Cross References</u> Fram CFA9587 Mann CUK2940 Micronair MC571 Purflux AHC179 Tecocar EC382 Fiaam PCK8109</p>
 <ul style="list-style-type: none"> I Il filtro è posizionato nel vano motore sul lato passeggero GB The filter is located in the engine compartment on the passenger's side F Le filtre est situé dans le compartiment moteur du côté passager D Der filter befindet sich Motorraum auf der Beifahrerseite E El filtro se encuentra en el compartimiento del motor, del lado del acompañante 					

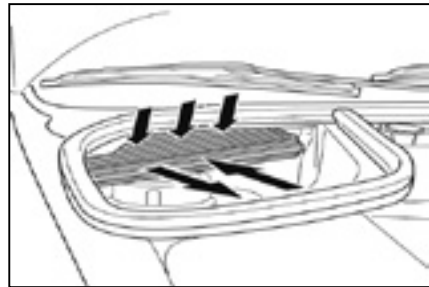
--- 108 ---	05/14 ->	*	*	<p>CK 20013 194 x 145 x 30</p>  <p><u>O/E numbers</u> Peugeot B000975480</p> <p><u>Cross References</u> Fram Mann CU20013 Micronair Purflux Tecocar Fiaam</p>	---
 <ul style="list-style-type: none"> I Il filtro è posizionato nell'abitacolo dietro il vano portaoggetti GB The filter is located in the passenger compartment behind the glove compartment F Le filtre est situé dans l'habitacle derrière la boîte à gants D Der filter befindet sich im Fahrgastraum hinter dem Handshuhfach E El filtro se encuentra en el habitáculo detrás de la guantera 					

--- 206 ---	08/98 ->	*	*	<p>CK 9071 345/333 x 164/154 x 29</p>  <p><u>O/E numbers</u> Peugeot 6447AZ</p> <p><u>Cross References</u> Fram CF9071 Mann CU3448 Micronair MP057 Purflux AH140 Tecocar E341 Fiaam PC8060</p>	<p>CK 9071-C 345/333 x 164/154 x 29</p>  <p><u>O/E numbers</u> Peugeot 6447PE</p> <p><u>Cross References</u> Fram CFA9071 Mann CUK3448 Micronair MC557 Purflux AHC140 Tecocar Fiaam PCK8060</p>
 <ul style="list-style-type: none"> I Il filtro è posizionato nel vano motore sul lato passeggero GB The filter is located in the engine compartment on the passenger's side F Le filtre est situé dans le compartiment moteur du côté passager D Der filter befindet sich Motorraum auf der Beifahrerseite E El filtro se encuentra en el compartimiento del motor, del lado del acompañante 					

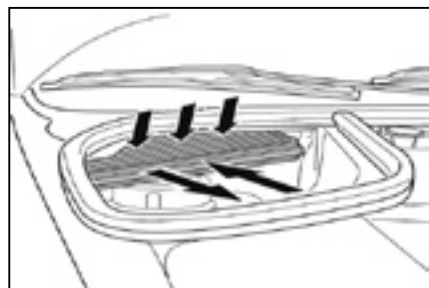





--- 206 Plus ---	03/09 ->	*	*	<p>CK 9071 345/333 x 164/154 x 29</p>  <p><u>O/E numbers</u> Peugeot 6447AZ</p> <p><u>Cross References</u> Fram CF9071 Mann CU3448 Micronair MP057 Purflux AH140 Tecocar E341 Fiaam PC8060</p>	<p>CK 9071-C 345/333 x 164/154 x 29</p>  <p><u>O/E numbers</u> Peugeot 6447PE</p> <p><u>Cross References</u> Fram CFA9071 Mann CUK3448 Micronair MC557 Purflux AHC140 Tecocar Fiaam PCK8060</p>
 <p>Il filtro è posizionato nel vano motore sul lato passeggero The filter is located in the engine compartment on the passenger's side Le filtre est situé dans le compartiment moteur du côté passager Der filter befindet sich Motorraum auf der Beifahrerseite El filtro se encuentra en el compartimiento del motor, del lado del acompañante</p>					

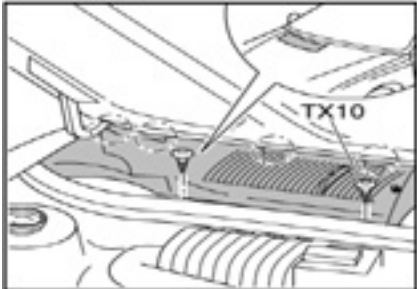
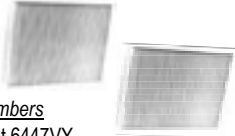

Anti-pollen

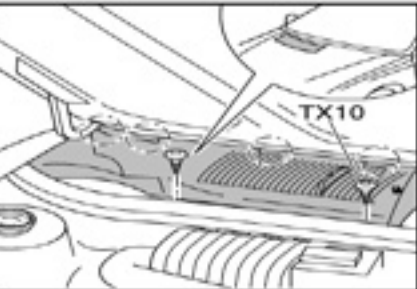
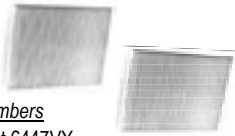
Activated carbon

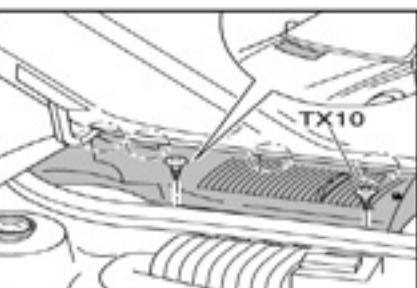
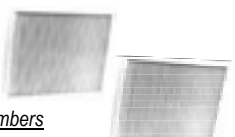
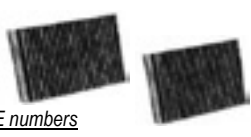
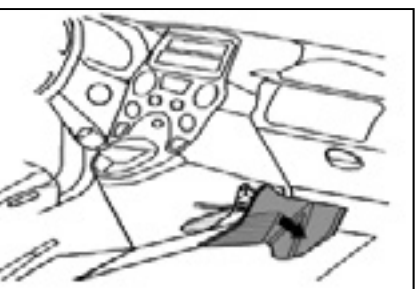
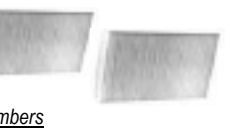
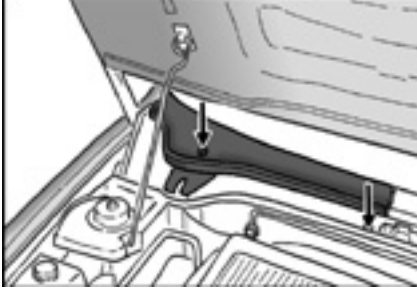
PEUGEOT



<p>--- 207 ---</p>  <p>Il filtro è posizionato nel vano motore</p> <p>The filter is located in the engine compartment</p> <p>Le filtre est situé dans le compartiment moteur</p> <p>Der Filter befindet sich im Motorraum</p> <p>El filtro se encuentra en el compartimiento del motor</p>	<p>02/06 -> * </p>	<p>CK 10205-2</p> <p>203 x 158 x 31 / 153 x 158 x 31</p>  <p><u>O/E numbers</u> Peugeot 6447VY</p> <p><u>Cross References</u> Fram CF10204-2 Mann CU21000-2 Micronair MP264-2 Purflux AH245 Tecnocar E461-2 Fiaam PC8241-2</p>	<p>CK 10205-C-2</p> <p>203 x 158 x 31 / 153 x 158 x 31</p>  <p><u>O/E numbers</u> Peugeot 6447VX</p> <p><u>Cross References</u> Fram CFA10205-2 Mann CUK21000-2 Micronair MC764-2 Purflux AHC245 Tecnocar EC461-2 Fiaam PCK8173-2</p>
<p>--- 208 ---</p>  <p>Il filtro è posizionato nel vano motore</p> <p>The filter is located in the engine compartment</p> <p>Le filtre est situé dans le compartiment moteur</p> <p>Der Filter befindet sich im Motorraum</p> <p>El filtro se encuentra en el compartimiento del motor</p>	<p>04/12 -> * </p>	<p>CK 10205-2</p> <p>203 x 158 x 31 / 153 x 158 x 31</p>  <p><u>O/E numbers</u> Peugeot 6447VY</p> <p><u>Cross References</u> Fram CF10204-2 Mann CU21000-2 Micronair MP264-2 Purflux AH245 Tecnocar E461-2 Fiaam PC8241-2</p>	<p>CK 10205-C-2</p> <p>203 x 158 x 31 / 153 x 158 x 31</p>  <p><u>O/E numbers</u> Peugeot 6447VX</p> <p><u>Cross References</u> Fram CFA10205-2 Mann CUK21000-2 Micronair MC764-2 Purflux AHC245 Tecnocar EC461-2 Fiaam PCK8173-2</p>
<p>--- 2008 ---</p>  <p>Il filtro è posizionato nel vano motore</p> <p>The filter is located in the engine compartment</p> <p>Le filtre est situé dans le compartiment moteur</p> <p>Der Filter befindet sich im Motorraum</p> <p>El filtro se encuentra en el compartimiento del motor</p>	<p>03/13 -> * </p>	<p>CK 10205-2</p> <p>203 x 158 x 31 / 153 x 158 x 31</p>  <p><u>O/E numbers</u> Peugeot 6447VY</p> <p><u>Cross References</u> Fram CF10204-2 Mann CU21000-2 Micronair MP264-2 Purflux AH245 Tecnocar E461-2 Fiaam PC8241-2</p>	<p>CK 10205-C-2</p> <p>203 x 158 x 31 / 153 x 158 x 31</p>  <p><u>O/E numbers</u> Peugeot 6447VX</p> <p><u>Cross References</u> Fram CFA10205-2 Mann CUK21000-2 Micronair MC764-2 Purflux AHC245 Tecnocar EC461-2 Fiaam PCK8173-2</p>
<p>--- 301 ---</p>  <p>Il filtro è posizionato nell'abitacolo sotto il vano portaoggetti</p> <p>The filter is located in the passenger compartment under the glove compartment</p> <p>Le filtre est situé dans l'habitacle en dessous de la boîte à gants</p> <p>Der filter befindet sich im Fahrgastraum unter dem Handschuhfach</p> <p>El filtro se encuentra en el habitáculo, bajo la guantera de pasajerruimte</p>	<p>01/13 -> * </p>	<p>CK 921-2</p> <p>240 x 84 x 20</p>  <p><u>O/E numbers</u> Peugeot 9678792080</p> <p><u>Cross References</u> Fram CF11745-2 Mann CU24012-2 Micronair Purflux AH415-2 Tecnocar E706-2 Fiaam PC8385-2</p>	<p>---</p>
<p>--- 306 ---</p>  <p>Il filtro è posizionato nel vano motore sul lato passeggero</p> <p>The filter is located in the engine compartment on the passenger's side</p> <p>Le filtre est situé dans le compartiment moteur du côté passager</p> <p>Der filter befindet sich im Motorraum auf der Beifahrerseite</p> <p>El filtro se encuentra en el compartimiento del motor, del lado del acompañante</p>	<p>05/93 -> * </p>	<p>CK 3435</p> <p>335/35 x 115/105 x 31</p>  <p><u>O/E numbers</u> Peugeot 002484</p> <p><u>Cross References</u> Fram CF11785 Mann CU3435 Micronair MP251 Purflux AH423 Tecnocar E716 Fiaam PC8394</p>	<p>CK 3435-C</p> <p>335/35 x 115/105 x 31</p>  <p><u>O/E numbers</u> Peugeot 0002442</p> <p><u>Cross References</u> Fram..... Mann..... Micronair MC751 Purflux..... Tecnocar..... Fiaam.....</p>







Anti-pollen

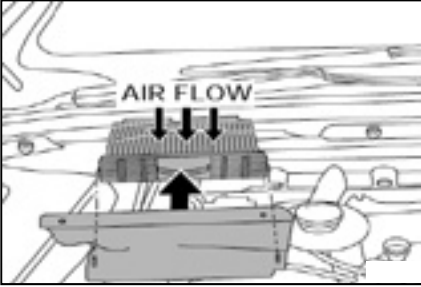

Activated carbon

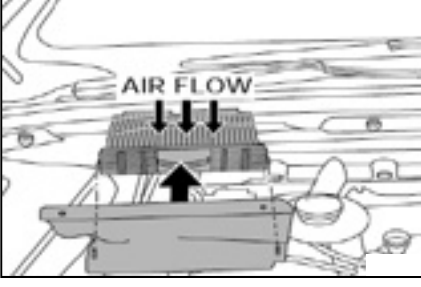
PEUGEOT

--- 307 ---	03/01 ->	*		<p>CK 9398 284 x 175 x 36</p>  <p><u>O/E numbers</u> Peugeot 6447KK <u>Cross References</u> Fram CF9398 Mann CU2940 Micronair MP071 Purflux AH179 Tecnocar E382 Fiaam PC8088</p>	<p>CK 9398-C 284 x 175 x 36</p>  <p><u>O/E numbers</u> Peugeot 6447KL <u>Cross References</u> Fram CFA9587 Mann CUK2940 Micronair MC571 Purflux AHC179 Tecnocar EC382 Fiaam PCK8109</p>
 <p>AIR FLOW</p> <p>Il filtro è posizionato nel vano motore sul lato passeggero The filter is located in the engine compartment on the passenger's side Le filtre est situé dans le compartiment moteur du côté passager Der filter befindet sich Motorraum auf der Beifahrerseite El filtro se encuentra en el compartimiento del motor, del lado del acompañante</p>					

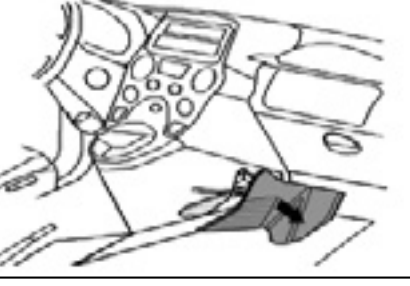
--- 308 ---	09/07 ->	*		<p>CK 9398 284 x 175 x 36</p>  <p><u>O/E numbers</u> Peugeot 6447KK <u>Cross References</u> Fram CF9398 Mann CU2940 Micronair MP071 Purflux AH179 Tecnocar E382 Fiaam PC8088</p>	<p>CK 9398-C 284 x 175 x 36</p>  <p><u>O/E numbers</u> Peugeot 6447KL <u>Cross References</u> Fram CFA9587 Mann CUK2940 Micronair MC571 Purflux AHC179 Tecnocar EC382 Fiaam PCK8109</p>
 <p>AIR FLOW</p> <p>Il filtro è posizionato nel vano motore sul lato passeggero The filter is located in the engine compartment on the passenger's side Le filtre est situé dans le compartiment moteur du côté passager Der filter befindet sich Motorraum auf der Beifahrerseite El filtro se encuentra en el compartimiento del motor, del lado del acompañante</p>					

--- 308 II ---	09/13 ->	*		<p>CK 26014-2 260 x 98 x 32</p>  <p><u>O/E numbers</u> Peugeot 9804163380 <u>Cross References</u> Fram CF11808-2 Mann CU26014-2 Micronair MP457-2 Purflux AH425-2 Tecnocar E718-2 Fiaam PC8396-2</p>	<p>CK 26014-C-2 260 x 98 x 32</p>  <p><u>O/E numbers</u> Peugeot 9804163480 <u>Cross References</u> Fram CFA11808-2 Mann CUK26014-2 Micronair Purflux AHC425-2 Tecnocar EC718-2 Fiaam PCK8396-2</p>
 <p>Il filtro è posizionato nell'abitacolo sotto il vano portaoggetti The filter is located in the passenger compartment under the glove compartment Le filtre est situé dans l'habitacle en dessous de la boîte à gants Der filter befindet sich im Fahrgastraum unter dem Handshuhfach El filtro se encuentra en el habitáculo, bajo la guantera en el compartimiento de pasajero</p>					

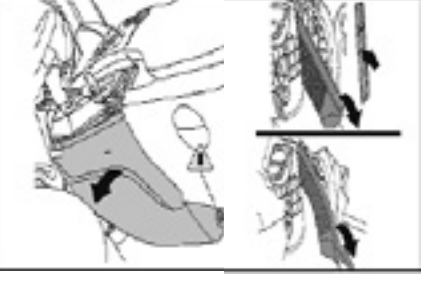
--- 3008 ---	06/09 ->	*		<p>CK 10536-10-2 291 x 97 x 30</p>  <p><u>O/E numbers</u> Peugeot 6447992 <u>Cross References</u> Fram CF10536-2 Mann CU3039-2 Micronair MP201-2 Purflux AH261 Tecnocar E475-2 Fiaam PC8218-2</p>	<p>CK 10536-10-C-2 291 x 97 x 30</p>  <p><u>O/E numbers</u> Peugeot 6447993 <u>Cross References</u> Fram CFA10419-2 Mann CUK3039-2 Micronair MC701-2 Purflux AHC261 Tecnocar EC475-2 Fiaam PCK8204-2</p>
 <p>Il filtro è posizionato nell'abitacolo dietro il vano portaoggetti The filter is located in the passenger compartment behind the glove compartment Le filtre est situé dans l'habitacle derrière la boîte à gants Der filter befindet sich im Fahrgastraum hinter dem Handshuhfach El filtro se encuentra en el habitáculo detrás de la guantera</p>					

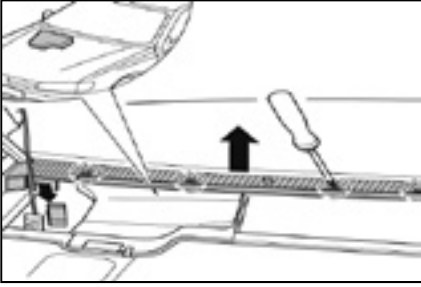

--- 405 ---	09/92 -> 10/96	*	*	<p>CK 5864 263/253 x 176/166 x 28</p>  <p><u>O/E numbers</u> Peugeot 644793 <u>Cross References</u> Fram CF5864 Mann CU2861 Micronair MP012 Purflux AH114 Tecnocar E317 Fiaam PC8018</p>	
 <p>Il filtro è posizionato nel vano motore sul lato passeggero The filter is located in the engine compartment on the passenger's side Le filtre est situé dans le compartiment moteur du côté passager Der filter befindet sich Motorraum auf der Beifahrerseite El filtro se encuentra en el compartimiento del motor, del lado del acompañante</p>					





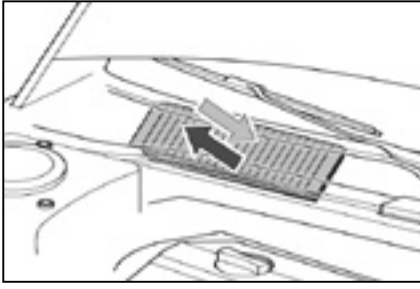

Anti-pollen

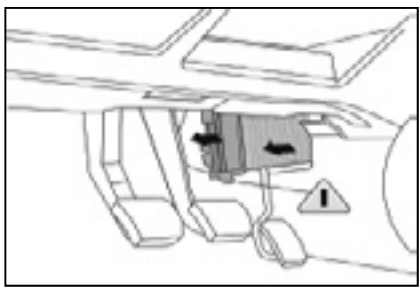

Activated carbon

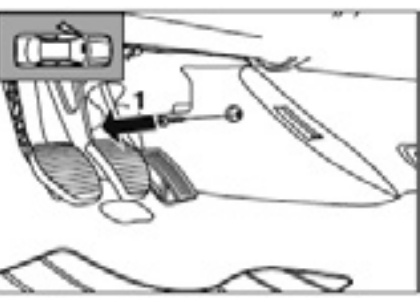

PEUGEOT

<p>--- 406 ---</p> 	<p>10/95 -> 05/04</p> <p>* *</p> <p>I Il filtro è posizionato nel vano motore sul lato passeggero GB The filter is located in the engine compartment on the passenger's side F Le filtre est situé dans le compartiment moteur du côté passager D Der filter befindet sich Motorraum auf der Beifahrerseite E El filtro se encuentra en el compartimiento del motor, del lado del acompañante</p>	<p>CK 5846 325/302 x 161,5 x 38</p>  <p><u>O/E numbers</u> Peugeot 6447S5 <u>Cross References</u> Fram CF5846 Mann CU3340/CU3360 Micronair MP055 Purflux AH102 Tecocar E306 Fiaam PC8020</p>	<p>CK 5846-C 325/302 x 161,5 x 38</p>  <p><u>O/E numbers</u> Peugeot 6447PG <u>Cross References</u> Fram CFA5846 Mann CUK3340/CUK3360 Micronair MC555 Purflux AHC102 Tecocar..... Fiaam PCK8020</p>
---	---	---	---

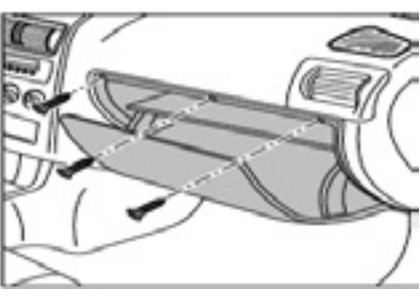
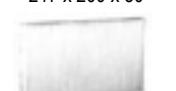
<p>--- 407 --- -> Chassis ORGA 11437</p> 	<p>04/04 -> 02/08</p> <p>* *</p> <p>I Il filtro è posizionato nell'abitacolo sul lato conducente GB The filter is located in the passenger compartment on the driver's side F Le filtre est situé dans l'habitacle du côté conducteur D Der Filter befindet sich im Fahrgastraum auf der Fahrerseite E El Filtro se encuentra en el habitáculo, del lado del conductor</p>	<p>---</p>	<p>CK 9920-C 315 x 152 x 40</p>  <p><u>O/E numbers</u> Peugeot 6447RG <u>Cross References</u> Fram CFA9920 Mann CUK3240 Micronair MC640 Purflux AHC213 Tecocar EC417 Fiaam PCK8153</p>
--	--	------------	--

<p>--- 407 --- Chassis ORGA 11438 -></p> 	<p>03/08 -></p> <p>* </p> <p>I Il filtro è posizionato nell'abitacolo sul lato conducente GB The filter is located in the passenger compartment on the driver's side F Le filtre est situé dans l'habitacle du côté conducteur D Der Filter befindet sich im Fahrgastraum auf der Fahrerseite E El Filtro se encuentra en el habitáculo, del lado del conductor</p>	<p>CK 10529 270 x 196 x 32</p>  <p><u>O/E numbers</u> Peugeot</p> <p><u>Cross References</u> Fram Mann Micronair MP367 Purflux Tecocar Fiaam</p>	<p>CK 10529-C 270 x 196 x 32</p>  <p><u>O/E numbers</u> Peugeot 647946 <u>Cross References</u> Fram CFA10529 Mann CUK2742 Micronair MC867 Purflux AHC272 Tecocar Fiaam PCK8216</p>
--	---	---	--

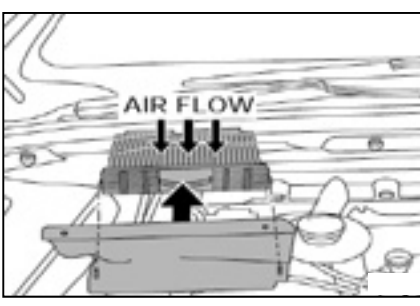
<p>--- 4007 ---</p> 	<p>09/07 -></p> <p> </p> <p>I Il filtro è posizionato nell'abitacolo dietro il vano portaoggetti GB The filter is located in the passenger compartment behind the glove compartment F Le filtre est situé dans l'habitacle derrière la boîte à gants D Der filter befindet sich im Fahrgastraum hinter dem Handsuhlfach E El filtro se encuentra en el habitáculo detrás de la guantera</p>	<p>CK 10431 217 x 200 x 30</p>  <p><u>O/E numbers</u> Peugeot 6447ZX / 6479E9 <u>Cross References</u> Fram CF10431 Mann CU2141 Micronair MP247 Purflux AH262 Tecocar E472 Fiaam PC8201</p>	<p>CK 10431-C 217 x 200 x 30</p>  <p><u>O/E numbers</u> Peugeot..... <u>Cross References</u> Fram CFA10431 Mann CUK2141 Micronair MC747 Purflux AHC262 Tecocar EC472 Fiaam PCK8201</p>
--	---	---	--



<p>--- 408 ---</p> 	<p>09/12 -></p> <p>* </p> <p>I Il filtro è posizionato nel vano motore sul lato passeggero GB The filter is located in the engine compartment on the passenger's side F Le filtre est situé dans le compartiment moteur du côté passager D Der filter befindet sich Motorraum auf der Beifahrerseite E El filtro se encuentra en el compartimiento del motor, del lado del acompañante</p>	<p>CK 9398 284 x 175 x 36</p>  <p><u>O/E numbers</u> Peugeot 6447KK <u>Cross References</u> Fram CF9398 Mann CU2940 Micronair MP071 Purflux AH179 Tecocar E382 Fiaam PC8088</p>	<p>CK 9398-C 284 x 175 x 36</p>  <p><u>O/E numbers</u> Peugeot 6447KL <u>Cross References</u> Fram CFA9587 Mann CUK2940 Micronair MC571 Purflux AHC179 Tecocar EC382 Fiaam PCK8109</p>
---	--	--	--





Anti-pollen

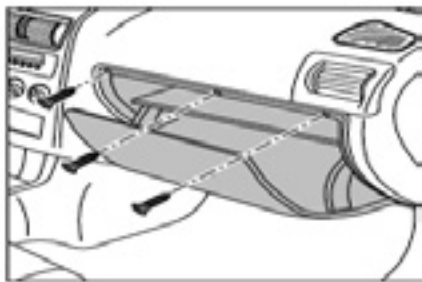

Activated carbon

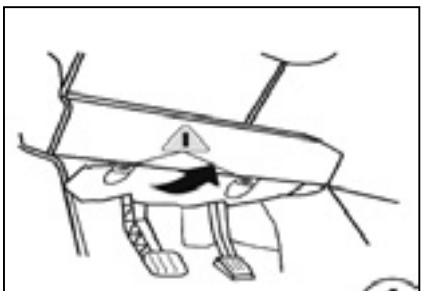

PEUGEOT

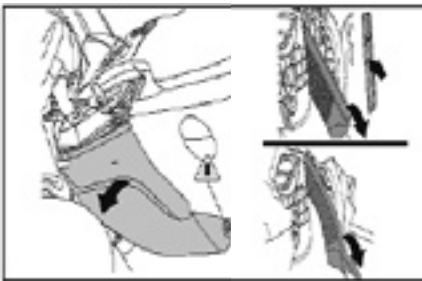
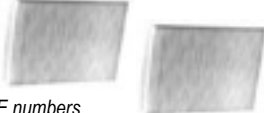
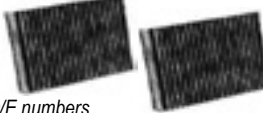
<p>--- 4008 ---</p>  <p>I Il filtro è posizionato nell'abitacolo dietro il vano portaoggetti</p> <p>CB The filter is located in the passenger compartment behind the glove compartment</p> <p>F Le filtre est situé dans l'habitacle derrière la boîte à gants</p> <p>D Der filter befindet sich im Fahrgastraum hinter dem Handshuhfach</p> <p>E El filtro se encuentra en el habitáculo detrás de la guantera</p>	<p>04/12 -></p>	<p>CK 10431 217 x 200 x 30</p>  <p><u>O/E numbers</u> Peugeot 6447ZX / 6479E9</p> <p><u>Cross References</u> Fram CF10431 Mann CU2141 Micronair MP247 Purflux AH262 Tecnocar E472 Fiaam PC8201</p>	<p>CK 10431-C 217 x 200 x 30</p>  <p><u>O/E numbers</u> Peugeot.....</p> <p><u>Cross References</u> Fram CFA10431 Mann CUK2141 Micronair MC747 Purflux AHC262 Tecnocar EC472 Fiaam PCK8201</p>
--	--------------------	--	---

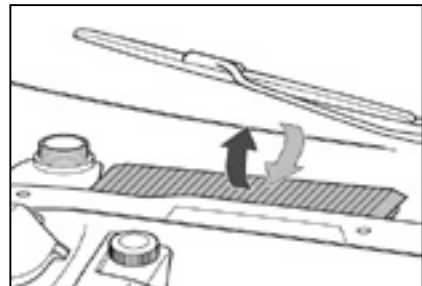
<p>--- 508 ---</p>  <p>I Il filtro è posizionato nell'abitacolo sul lato conducente</p> <p>CB The filter is located in the passenger compartment on the driver's side</p> <p>F Le filtre est situé dans l'habitacle du côté conducteur</p> <p>D Der Filter befindet sich im Fahrgastraum auf der Fahrerseite</p> <p>E El Filtro se encuentra en el habitáculo, del lado del conductor</p>	<p>11/10 -></p>	<p>---</p>	<p>CK 2743-C 270 x 187 x 35</p>  <p><u>O/E numbers</u> Peugeot 6479K9</p> <p><u>Cross References</u> Fram CFA11285 Mann CUK2743 Micronair MC918 Purflux AHC352 Tecnocar EC645 Fiaam PCK8320</p>
--	--------------------	------------	--

<p>--- 5008 ---</p>  <p>I Il filtro è posizionato nell'abitacolo dietro il vano portaoggetti</p> <p>CB The filter is located in the passenger compartment behind the glove compartment</p> <p>F Le filtre est situé dans l'habitacle derrière la boîte à gants</p> <p>D Der filter befindet sich im Fahrgastraum hinter dem Handshuhfach</p> <p>E El filtro se encuentra en el habitáculo detrás de la guantera</p>	<p>09/09 -> * *</p>	<p>CK 10536-10-2 291 x 97 x 30</p>  <p><u>O/E numbers</u> Peugeot 6447992</p> <p><u>Cross References</u> Fram CF10536-2 Mann CU3039-2 Micronair MP201-2 Purflux AH261 Tecnocar E475-2 Fiaam PC8218-2</p>	<p>CK 10536-10-C-2 291 x 97 x 30</p>  <p><u>O/E numbers</u> Peugeot 6447993</p> <p><u>Cross References</u> Fram CFA10419-2 Mann CUK3039-2 Micronair MC701-2 Purflux AHC261 Tecnocar EC475-2 Fiaam PCK8204-2</p>
--	------------------------------	--	--

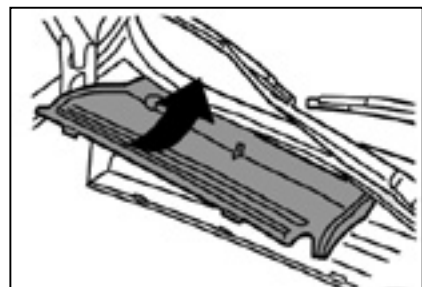
<p>--- 605 ---</p>  <p>I Il filtro è posizionato nel vano motore sul lato passeggero</p> <p>CB The filter is located in the engine compartment on the passenger's side</p> <p>F Le filtre est situé dans le compartiment moteur du côté passager</p> <p>D Der filter befindet sich im Motorraum auf der Beifahrerseite</p> <p>E El filtro se encuentra en el compartimiento del motor, del lado del acompañante</p>	<p>06/89 -> 09/99 * *</p>	<p>CK 5845 412/402 x 166/156 x 28</p>  <p><u>O/E numbers</u> Peugeot 6447K6</p> <p><u>Cross References</u> Fram CF5845 Mann CU4260 Micronair MP054 Purflux AH115 Tecnocar E318 Fiaam PC8019</p>	<p>---</p>
--	------------------------------------	---	------------



<p>--- 607 ---</p>  <p>I Il filtro è posizionato nel vano motore sul lato passeggero</p> <p>CB The filter is located in the engine compartment on the passenger's side</p> <p>F Le filtre est situé dans le compartiment moteur du côté passager</p> <p>D Der filter befindet sich im Motorraum auf der Beifahrerseite</p> <p>E El filtro se encuentra en el compartimiento del motor, del lado del acompañante</p>	<p>02/00 -></p>	<p>---</p>	<p>CK 384-C 530/501 x 144 x 38</p>  <p><u>O/E numbers</u> Peugeot 6447GW</p> <p><u>Cross References</u> Fram..... Mann CUK5258 Micronair MC659 Purflux AHC181 Tecnocar EC384 Fiaam.....</p>
--	--------------------	------------	--





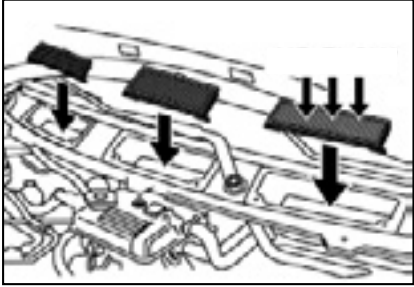

Anti-pollen

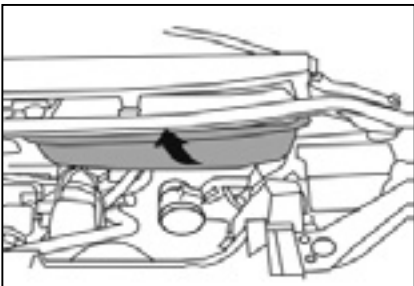

Activated carbon

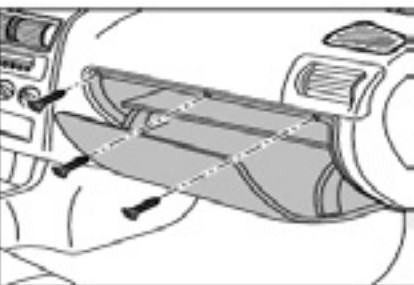

PEUGEOT

<p>--- 806 ---</p> 	<p>06/94 -> 08/02</p> <p>*</p>	<p>CK 8947-3</p> <p>1) 194 x 94/86 x 33 2) 194 x 67/64 x 33</p>  <p><u>O/E numbers</u> Peugeot 6447P2 / 6447P3</p> <p><u>Cross References</u> Fram CF8947/CF8948 Mann CU19000-3 Micronair MP087-3 Puflex AH112/AH113 Tecnocar E315/E316 Fiaam PC8055/PC8056</p>	<p>---</p>
---	-----------------------------------	--	------------

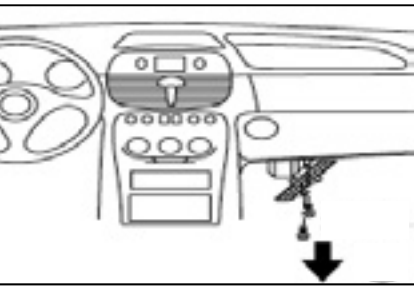
<p>--- 807 ---</p> 	<p>06/02 -></p> <p>*</p>	<p>CK 9586</p> <p>405 x 164 x 32</p>  <p><u>O/E numbers</u> Peugeot 6447SY</p> <p><u>Cross References</u> Fram CF9586 Mann CU4179 Micronair MP116 Puflex AH205 Tecnocar E408 Fiaam PC8108</p>	<p>CK 9586-C</p> <p>405 x 164 x 32</p>  <p><u>O/E numbers</u> Peugeot 6447TA</p> <p><u>Cross References</u> Fram CFA10307 Mann CUK4179 Micronair MC616 Puflex AHC205 Tecnocar EC408 Fiaam PCK8190</p>
---	-----------------------------	--	---

<p>--- Bipper --- Left-hand drive</p> 	<p>02/08 -></p> <p>*</p>	<p>CK 10413-10</p> <p>199 x 177,5 x 30</p>  <p><u>O/E numbers</u> Peugeot 647963</p> <p><u>Cross References</u> Fram CF10413 Mann CU2040 Micronair MP283 Puflex AH265 Tecnocar Fiaam PC8200</p>	<p>---</p>
--	-----------------------------	--	------------

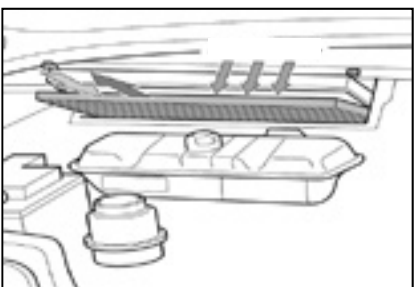
<p>--- Bipper --- Right-hand drive</p> 	<p>02/08 -></p> <p>*</p>	<p>CK 2243</p> <p>265 x 217 x 20,5</p>  <p><u>O/E numbers</u> Peugeot 647961</p> <p><u>Cross References</u> Fram CF10282 Mann CU2243 Micronair MP193 Puflex AH244 Tecnocar E465 Fiaam PC8170</p>	<p>CK 2243-C</p> <p>265 x 217 x 20,5</p>  <p><u>O/E numbers</u> Peugeot.....</p> <p><u>Cross References</u> Fram CFA10365 Mann CUK2243 Micronair MC693 Puflex AHC244 Tecnocar EC465 Fiaam PCK8194</p>
---	-----------------------------	---	---

<p>--- Boxer I ---</p> 	<p>03/94-> 03/02</p> <p>*</p>	<p>CK 8890</p> <p>435 x 144,5 x 17</p>  <p><u>O/E numbers</u> Peugeot 6447JO / 6447SY</p> <p><u>Cross References</u> Fram CF8890 Mann CU4442 Micronair MP013 Puflex AH231 Tecnocar E430 Fiaam PC8051</p>	<p>---</p>
---	----------------------------------	---	------------





Anti-pollen

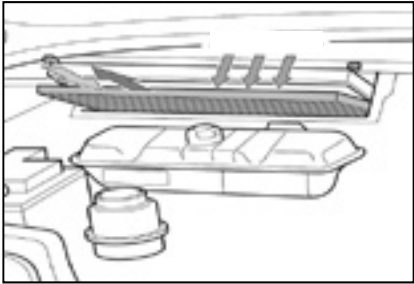

Activated carbon

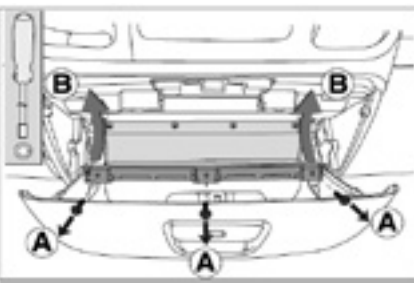

PEUGEOT

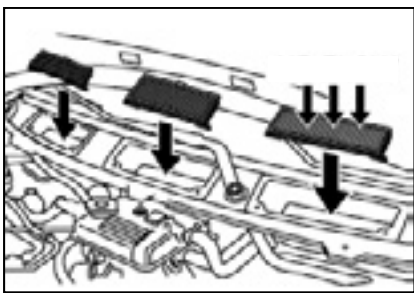
--- Boxer II ---	02/02-> 06/06	*	<p>CK 8890 435 x 144,5 x 17</p>  <p><u>O/E numbers</u> Peugeot 6447JO / 6447SY</p> <p><u>Cross References</u> Fram CF8890 Mann CU4442 Micronair MP013 Purlux AH231 Tecocar E430 Fiaam PC8051</p>
	<p>I Il filtro è posizionato nel vano motore sul lato passeggero</p> <p>CB The filter is located in the engine compartment on the passenger's side</p> <p>F Le filtre est situé dans le compartiment moteur du côté passager</p> <p>D Der filter befindet sich Motorraum auf der Beifahrerseite</p> <p>E El filtro se encuentra en el compartimiento del motor, del lado del acompañante</p>		

--- Boxer III ---	07/06 ->	*	<p>CK 2544 250 x 234 x 25</p>  <p><u>O/E numbers</u> Peugeot 6447YA / 6479C9</p> <p><u>Cross References</u> Fram CF10420 Mann CU2544 Micronair MP262 Purlux AH263 Tecocar E476 Fiaam PC8205</p>
	<p>I Il filtro è posizionato nell'abitacolo dietro il vano portaoggetti</p> <p>CB The filter is located in the passenger compartment behind the glove compartment</p> <p>F Le filtre est situé dans l'habitacle derrière la boîte à gants</p> <p>D Der filter befindet sich im Fahrgastraum hinter dem Handshuhfach</p> <p>E El filtro se encuentra en el habitáculo detrás de la guantera</p>		

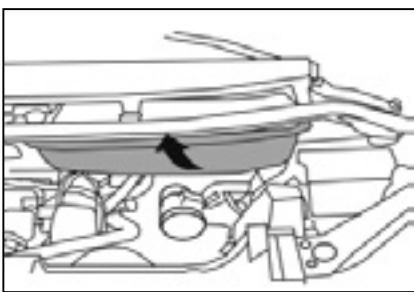
--- Expert I ---	02/96 -> 03/04	*	<p>CK 8947-3 1) 194 x 94/86 x 33 2) 194 x 67/64 x 33</p>  <p><u>O/E numbers</u> Peugeot 6447P2 / 6447P3</p> <p><u>Cross References</u> Fram CF8947/CF8948 Mann CU19000-3 Micronair MP087-3 Purlux AH112/AH113 Tecocar E315/E316 Fiaam PC8055/PC8056</p>
	<p>I Il filtro è posizionato nel vano motore sul lato passeggero</p> <p>CB The filter is located in the engine compartment on the passenger's side</p> <p>F Le filtre est situé dans le compartiment moteur du côté passager</p> <p>D Der filter befindet sich Motorraum auf der Beifahrerseite</p> <p>E El filtro se encuentra en el compartimiento del motor, del lado del acompañante</p>		

--- Expert I ---	04/04 -> 01/07	*	<p>CK 9586 405 x 164 x 32</p>  <p><u>O/E numbers</u> Peugeot 6447SY</p> <p><u>Cross References</u> Fram CF9586 Mann CU4179 Micronair MP116 Purlux AH205 Tecocar E408 Fiaam PC8108</p>	<p>CK 9586-C 405 x 164 x 32</p>  <p><u>O/E numbers</u> Peugeot 6447TA</p> <p><u>Cross References</u> Fram CFA10307 Mann CUK4179 Micronair MC616 Purlux AHC205 Tecocar EC408 Fiaam PCK8190</p>
	<p>I Il filtro è posizionato nel vano motore sul lato passeggero</p> <p>CB The filter is located in the engine compartment on the passenger's side</p> <p>F Le filtre est situé dans le compartiment moteur du côté passager</p> <p>D Der filter befindet sich Motorraum auf der Beifahrerseite</p> <p>E El filtro se encuentra en el compartimiento del motor, del lado del acompañante</p>			

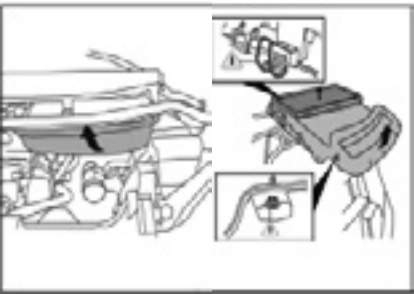
--- Expert II ---	01/07 ->	*	<p>CK 10366-10 375 x 175 x 48</p>  <p><u>O/E numbers</u> Peugeot 6447YJ</p> <p><u>Cross References</u> Fram Mann CU3847 Micronair MP300 Purlux Tecocar Fiaam</p>	<p>CK 10366-10-C 375 x 175 x 48</p>  <p><u>O/E numbers</u> Peugeot 6447YL</p> <p><u>Cross References</u> Fram CFA10366 Mann CUK3847 Micronair MC800 Purlux AHC258 Tecocar EC464 Fiaam PCK8193</p>
	<p>I Il filtro è posizionato nel vano motore</p> <p>CB The filter is located in the engine compartment</p> <p>F Le filtre est situé dans le compartiment moteur</p> <p>D Der Filter befindet sich im Motorraum</p> <p>E El filtro se encuentra en el compartimiento del motor</p>			





PEUGEOT

--- Partner (Ranch) ---

06/96 -> 10/02

*

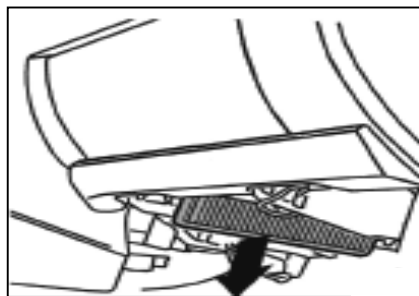

- I** Il filtro è posizionato nell'abitacolo sotto il vano portaoggetti
- GB** The filter is located in the passenger compartment under the glove compartment
- F** Le filtre est situé dans l'habitacle en dessous de la boîte à gants
- D** Der filter befindet sich im Fahrgastraum unter dem Handschuhfach
- E** El filtro se encuentra en el habitáculo, bajo la guantera de pasajerruimte

CK 5551

207/197 x 218/208 x 19



O/E numbers

Peugeot 6447Z5

Cross References

Fram CF5551 Mann CU2225
Micronair MP034 Purflux AH101
Tecocar E308 Fiaam PC8003

--- Partner (Ranch) ---

11/02 -> 12/09

*

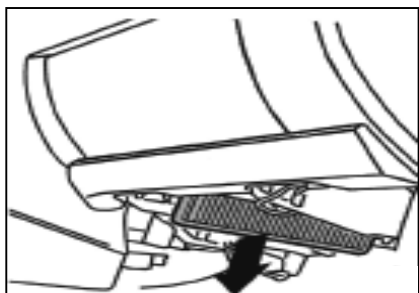

- I** Il filtro è posizionato nell'abitacolo sotto il vano portaoggetti
- GB** The filter is located in the passenger compartment under the glove compartment
- F** Le filtre est situé dans l'habitacle en dessous de la boîte à gants
- D** Der filter befindet sich im Fahrgastraum unter dem Handschuhfach
- E** El filtro se encuentra en el habitáculo, bajo la guantera de pasajerruimte

CK 9294

220 x 225 x 35



O/E numbers

Peugeot 6447KR

Cross References

Fram CF9294 Mann CU2245
Micronair MP173 Purflux AH193
Tecocar E396 Fiaam PC8076

CK 9294-C

220 x 225 x 35



O/E numbers

Peugeot 6447SZ

Cross References

Fram CFA9294 Mann CUK2245
Micronair MC673 Purflux AHC193
Tecocar..... Fiaam PCK8076

--- Partner II ---

04/08 ->

*



- I** Il filtro è posizionato nell'abitacolo dietro il vano portaoggetti
- GB** The filter is located in the passenger compartment behind the glove compartment
- F** Le filtre est situé dans l'habitacle derrière la boîte à gants
- D** Der filter befindet sich im Fahrgastraum hinter dem Handschuhfach
- E** El filtro se encuentra en el habitáculo detrás de la guantera

CK 10536-10-2

291 x 97 x 30

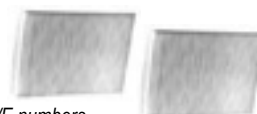

O/E numbers

Peugeot 6447992

Cross References

Fram CF10536-2 Mann CU3039-2
Micronair MP201-2 Purflux AH261
Tecocar E475-2 Fiaam PC8218-2

CK 10536-10-C-2

291 x 97 x 30

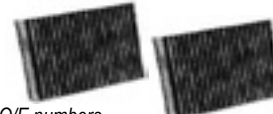

O/E numbers

Peugeot 6447993

Cross References

Fram CFA10419-2 Mann CUK3039-2
Micronair MC701-2 Purflux AHC261
Tecocar EC475-2 Fiaam PCK8204-2

--- RCZ ---

03/10 ->

*



- I** Il filtro è posizionato nel vano motore sul lato passeggero
- GB** The filter is located in the engine compartment on the passenger's side
- F** Le filtre est situé dans le compartiment moteur du côté passager
- D** Der filter befindet sich Motorraum auf der Beifahrerseite
- E** El filtro se encuentra en el compartimiento del motor, del lado del acompañante

CK 9398

284 x 175 x 36



O/E numbers

Peugeot 6447KK

Cross References

Fram CF9398 Mann CU2940
Micronair MP071 Purflux AH179
Tecocar E382 Fiaam PC8088

CK 9398-C

284 x 175 x 36

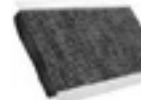

O/E numbers

Peugeot 6447KL

Cross References

Fram CFA9587 Mann CUK2940
Micronair MC571 Purflux AHC179
Tecocar EC382 Fiaam PCK8109



Anti-pollen

Activated carbon

PORSCHE

--- Boxster / Boxster S ---

09/96 -> 01/12

*

*

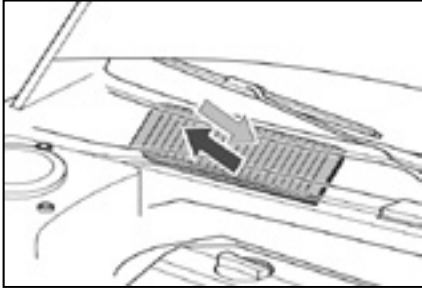

- I** Il filtro è posizionato nel vano motore, nel gruppo riscaldatore (climatizzatore)
- GB** The filter is located in the engine compartment at the heater (air-conditioner)
- F** Le filtre est situé dans le compartiment moteur sur le circuit de chauffage (la climatisation)
- D** Der Filter befindet sich im Motorraum beim Heizungssystem (Klimaanlage)
- E** El filtro se encuentra en el compartimiento del motor, en el sistema de calefacción (la instalación de aire acondicionado)

CK 5846

325/302 x 161,5 x 38



O/E numbers

Porsche 99657221902 / 99657221901

Cross References

Fram CF5846 Mann CU3340/CU3360
 Micronair MP055 Purflux AH102
 Tecocar E306 Fiaam PC8020

CK 5846-C

325/302 x 161,5 x 38



O/E numbers

Porsche 99657121903 / 99757121900

Cross References

Fram CFA5846 Mann CUK3340/CUK3360
 Micronair MC555 Purflux AHC102
 Tecocar..... Fiaam PCK8020

--- Cayenne I (955) ---

11/02 -> 05/10

*

*

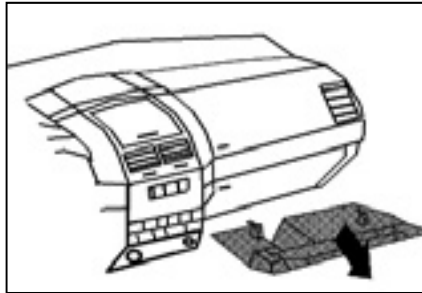

- I** Il filtro è posizionato nell'abitacolo sotto il vano portaoggetti
- GB** The filter is located in the passenger compartment under the glove compartment
- F** Le filtre est situé dans l'habitacle en dessous de la boîte à gants
- D** Der filter befindet sich im Fahrgastraum unter dem Handsuhfach
- E** El filtro se encuentra en el habitáculo, bajo la guantera de pasajerruimte

CK 9881

227 x 218 x 31



O/E numbers

Porsche.....

Cross References

Fram CF9881 Mann CU2842
 Micronair MP141 Purflux AH209
 Tecocar E413 Fiaam PC8158

CK 9881-C

227 X 218 X 31



O/E numbers

Porsche 95557221910

Cross References

Fram CFA9881 Mann CUK2842
 Micronair MC641 Purflux AHC209
 Tecocar EC413 Fiaam PCK8158

--- Cayenne II (958) ---

05/10 ->

*

*

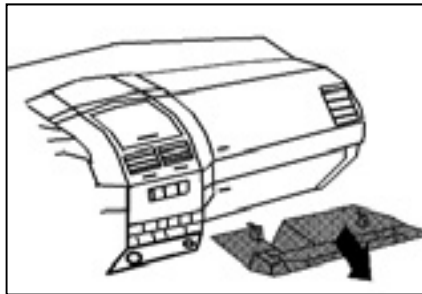

- I** Il filtro è posizionato nell'abitacolo sotto il vano portaoggetti
- GB** The filter is located in the passenger compartment under the glove compartment
- F** Le filtre est situé dans l'habitacle en dessous de la boîte à gants
- D** Der filter befindet sich im Fahrgastraum unter dem Handsuhfach
- E** El filtro se encuentra en el habitáculo, bajo la guantera de pasajerruimte

CK 2847-C

278 X 220 X 40



O/E numbers

Porsche 95857221900

Cross References

Fram CFA11429 Mann CUK2847
 Micronair MC917 Purflux AHC353
 Tecocar EC646 Fiaam PCK8321

--- Cayman / Cayman R, S, GT4 ---

11/05 ->

*

*

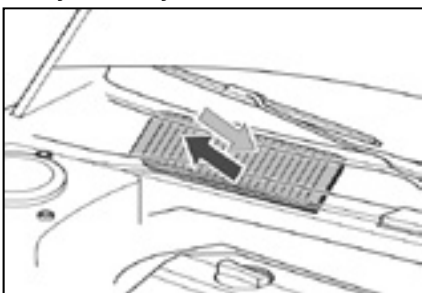

- I** Il filtro è posizionato nel vano motore, nel gruppo riscaldatore (climatizzatore)
- GB** The filter is located in the engine compartment at the heater (air-conditioner)
- F** Le filtre est situé dans le compartiment moteur sur le circuit de chauffage (la climatisation)
- D** Der Filter befindet sich im Motorraum beim Heizungssystem (Klimaanlage)
- E** El filtro se encuentra en el compartimiento del motor, en el sistema de calefacción (la instalación de aire acondicionado)

CK 5846

325/302 x 161,5 x 38



O/E numbers

Porsche 99657221902 / 99657221901

Cross References

Fram CF5846 Mann CU3340/CU3360
 Micronair MP055 Purflux AH102
 Tecocar E306 Fiaam PC8020

CK 5846-C

325/302 x 161,5 x 38



O/E numbers

Porsche 99657121903 / 99757121900

Cross References

Fram CFA5846 Mann CUK3340/CUK3360
 Micronair MC555 Purflux AHC102
 Tecocar..... Fiaam PCK8020

--- Macan ---

03/14 ->

*



- I** Il filtro è posizionato nell'abitacolo dietro il vano portaoggetti
- GB** The filter is located in the passenger compartment behind the glove compartment
- F** Le filtre est situé dans l'habitacle derrière la boîte à gants
- D** Der filter befindet sich im Fahrgastraum hinter dem Handsuhfach
- E** El filtro se encuentra en el habitáculo detrás de la guantera

CK 10457

238 x 280/189 x 35



O/E numbers

Audi 8K0819439

Cross References

Fram CF10457 Mann CU2450
 Micronair MP271 Purflux AH269
 Tecocar E478 Fiaam PC8209

CK 10457-C

238 x 280/189 x 35



O/E numbers

Audi 8K0819439A

Cross References

Fram CFA10458 Mann CUK2450
 Micronair MC771 Purflux AHC269
 Tecocar EC478 Fiaam PCK8120



Anti-pollen

Activated carbon

PORSCHE

--- 911 (996) ---

06/97 -> 05/06

*

*

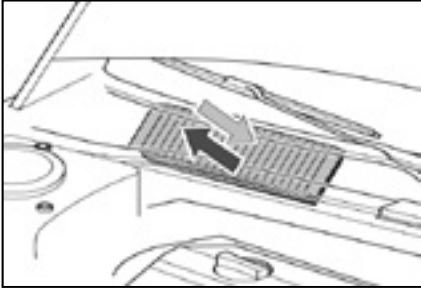

- I** Il filtro è posizionato nel vano motore, nel gruppo riscaldatore (climatizzatore)
- GB** The filter is located in the engine compartment at the heater (air-conditioner)
- F** Le filtre est situé dans le compartiment moteur sur le circuit de chauffage (la climatisation)
- D** Der Filter befindet sich im Motorraum beim Heizungssystem (Klimaanlage)
- E** El fitro se encuentra en el compartimiento del motor, en el sistema de calefacción (la instalación de aire acondicionado)

CK 5846

325/302 x 161,5 x 38



O/E numbers

Porsche 99657221902 / 99657221901

Cross References

Fram CF5846 Mann CU3340/CU3360
 Micronair MP055 Purflux AH102
 Tecnocar E306 Fiaam PC8020

CK 5846-C

325/302 x 161,5 x 38



O/E numbers

Porsche 99657121903 / 99757121900

Cross References

Fram CFA5846 Mann CUK3340/CUK3360
 Micronair MC555 Purflux AHC102
 Tecnocar..... Fiaam PCK8020

--- 911 (997) ---

07/04 ->

*

*

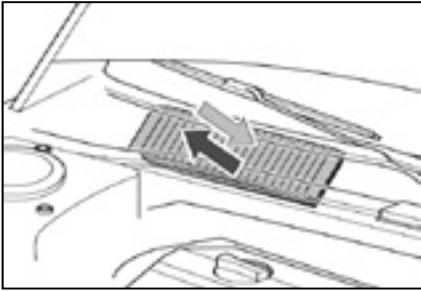

- I** Il filtro è posizionato nel vano motore, nel gruppo riscaldatore (climatizzatore)
- GB** The filter is located in the engine compartment at the heater (air-conditioner)
- F** Le filtre est situé dans le compartiment moteur sur le circuit de chauffage (la climatisation)
- D** Der Filter befindet sich im Motorraum beim Heizungssystem (Klimaanlage)
- E** El fitro se encuentra en el compartimiento del motor, en el sistema de calefacción (la instalación de aire acondicionado)

CK 5846

325/302 x 161,5 x 38



O/E numbers

Porsche 99657221902 / 99657221901

Cross References

Fram CF5846 Mann CU3340/CU3360
 Micronair MP055 Purflux AH102
 Tecnocar E306 Fiaam PC8020

CK 5846-C

325/302 x 161,5 x 38



O/E numbers

Porsche 99657121903 / 99757121900

Cross References

Fram CFA5846 Mann CUK3340/CUK3360
 Micronair MC555 Purflux AHC102
 Tecnocar..... Fiaam PCK8020



Anti-pollen

Activated carbon

RENAULT

--- Avantime ---

06/01 -> 05/03

*

*

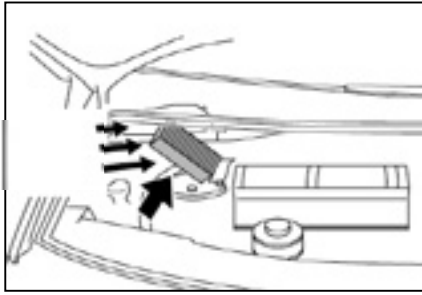

- I** Il filtro è posizionato nel vano motore
- GB** The filter is located in the engine compartment
- F** Le filtre est situé dans le compartiment moteur
- D** Der Filter befindet sich im Motorraum
- E** El filtro se encuentra en el compartimiento del motor

CK 8832-2

195 x 191 x 30

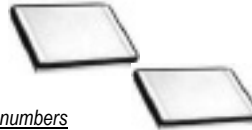

O/E numbers

Renault 6025370624

Cross References

Fram CF8832 Mann CU1931-2
Micronair MP068-2 Purflux AH163
TecnoCar E354 Fiaam PC8041

--- Captur ---

05/13 ->

*

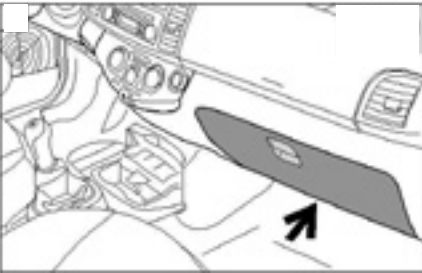

- I** Il filtro è posizionato nell'abitacolo sotto il vano portaoggetti
- GB** The filter is located in the passenger compartment under the glove compartment
- F** Le filtre est situé dans l'habitacle en dessous de la boîte à gants
- D** Der filter befindet sich im Fahrgastraum unter dem Handshuhfach
- E** El filtro se encuentra en el habitáculo, bajo la guanterain de pasajerruimte

CK 22011

216 x 200 x 35



O/E numbers

Renault 272773016R / 272778214R

Cross References

Fram CF11706 Mann CU22011
Micronair MP428 Purflux AH405
TecnoCar E626 Fiaam PC8374

CK 22011-C

216 x 200 x 35



O/E numbers

Renault 272770567R / 272779683R

Cross References

Fram CFA11706 Mann CUK22011
Micronair Purflux AHC405
TecnoCar EC696 Fiaam PCK8374

--- Clio II ---

09/98 ->

*



- I** Il filtro è posizionato nel vano motore
- GB** The filter is located in the engine compartment
- F** Le filtre est situé dans le compartiment moteur
- D** Der Filter befindet sich im Motorraum
- E** El filtro se encuentra en el compartimiento del motor

CK 8838

229 x 159 x 30



O/E numbers

Renault 7700424098

Cross References

Fram CF8838 Mann CU2945
Micronair MP033 Purflux AH143
TecnoCar E344 Fiaam PC8059

CK 8838-C

229 x 159 x 30



O/E numbers

Renault 7711228912

Cross References

Fram CFA8838 Mann CUK2945
Micronair MC533 Purflux AHC143
TecnoCar EC344 Fiaam PCK8059

--- Clio III ---

09/05 ->

*

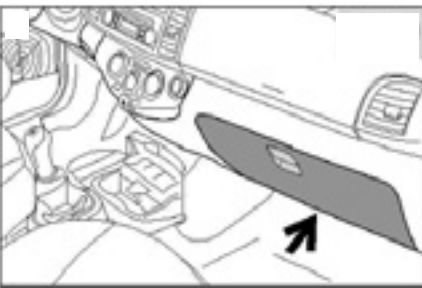

- I** Il filtro è posizionato nell'abitacolo sotto il vano portaoggetti
- GB** The filter is located in the passenger compartment under the glove compartment
- F** Le filtre est situé dans l'habitacle en dessous de la boîte à gants
- D** Der filter befindet sich im Fahrgastraum unter dem Handshuhfach
- E** El filtro se encuentra en el habitáculo, bajo la guanterain de pasajerruimte

CK 9691

205 x 181,5 x 27,5/42



O/E numbers

Renault 7701059997 / 7701062227

Cross References

Fram CF9691 Mann CU1829
Micronair MP179 Purflux AH207
TecnoCar E411 Fiaam PC8128

--- Clio IV ---

11/12 ->

*

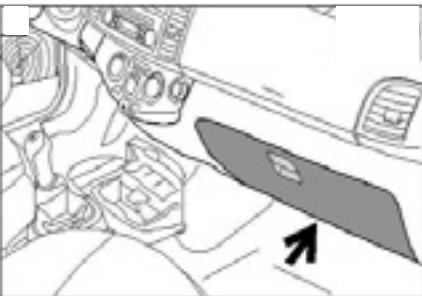

- I** Il filtro è posizionato nell'abitacolo sotto il vano portaoggetti
- GB** The filter is located in the passenger compartment under the glove compartment
- F** Le filtre est situé dans l'habitacle en dessous de la boîte à gants
- D** Der filter befindet sich im Fahrgastraum unter dem Handshuhfach
- E** El filtro se encuentra en el habitáculo, bajo la guanterain de pasajerruimte

CK 22011

216 x 200 x 35



O/E numbers

Renault 272773016R / 272778214R

Cross References

Fram CF11706 Mann CU22011
Micronair MP428 Purflux AH405
TecnoCar E626 Fiaam PC8374

CK 22011-C

216 x 200 x 35



O/E numbers

Renault 272770567R / 272779683R

Cross References

Fram CFA11706 Mann CUK22011
Micronair Purflux AHC405
TecnoCar EC696 Fiaam PCK8374





Anti-pollen

Activated carbon

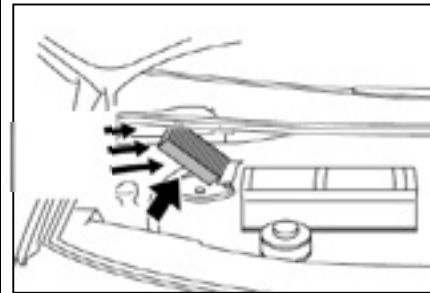
RENAULT

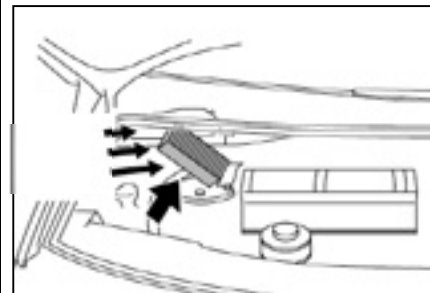
--- Espace II ---	03/96 -> 10/96	*	*	<p>CK 8832-2 195 x 191 x 30</p>  <p><u>O/E numbers</u> Renault 6025370624</p> <p><u>Cross References</u> Fram CF8832 Mann CU1931-2 Micronair MP068-2 Purflux AH163 Tecnocar E354 Fiaam PC8041</p>	
 <p>I Il filtro è posizionato nel vano motore GB The filter is located in the engine compartment F Le filtre est situé dans le compartiment moteur D Der Filter befindet sich im Motorraum E El filtro se encuentra en el compartimiento del motor</p>					

--- Espace III ---	03/96 -> 11/02	*	*	<p>CK 8832-2 195 x 191 x 30</p>  <p><u>O/E numbers</u> Renault 6025370624</p> <p><u>Cross References</u> Fram CF8832 Mann CU1931-2 Micronair MP068-2 Purflux AH163 Tecnocar E354 Fiaam PC8041</p>	
 <p>I Il filtro è posizionato nel vano motore GB The filter is located in the engine compartment F Le filtre est situé dans le compartiment moteur D Der Filter befindet sich im Motorraum E El filtro se encuentra en el compartimiento del motor</p>					

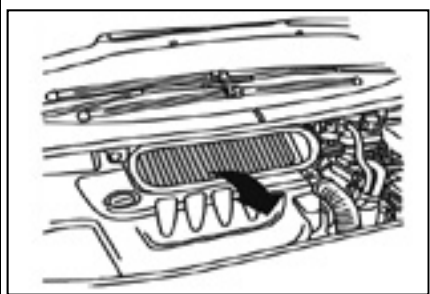
--- Espace IV---	10/02 ->	*	*	<p>CK 9827 386 x 155 x 30/50</p>  <p><u>O/E numbers</u> Renault 7701056389</p> <p><u>Cross References</u> Fram CF9827 Mann CU3840 Micronair MP115 Purflux AH203 Tecnocar E406 Fiaam PC8142</p>	<p>CK 9827-C 386 x 155 x 30/50</p>  <p><u>O/E numbers</u> Renault 7701056390</p> <p><u>Cross References</u> Fram CFA9827 Mann CUK3840 Micronair MC615 Purflux AHC203 Tecnocar EC406 Fiaam PCK8142</p>
 <p>I Il filtro è posizionato nel vano motore GB The filter is located in the engine compartment F Le filtre est situé dans le compartiment moteur D Der Filter befindet sich im Motorraum E El filtro se encuentra en el compartimiento del motor</p>					

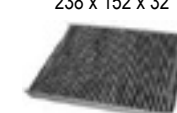
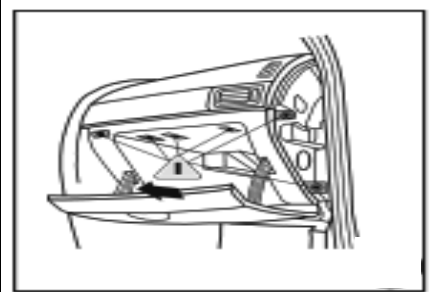
--- Fluence ---	02/10 ->	*	*	<p>CK 1629 238 x 152 x 32</p>  <p><u>O/E numbers</u> Renault 272772100R</p> <p><u>Cross References</u> Fram CF11119 Mann CU1629 Micronair MP413 Purflux AH306 Tecnocar E708 Fiaam PC8264</p>	<p>CK 1629-C 238 x 152 x 32</p>  <p><u>O/E numbers</u> Renault 272774936R</p> <p><u>Cross References</u> Fram CFA11119 Mann CUK1629 Micronair MC913 Purflux AHC309 Tecnocar..... Fiaam PCK8264</p>
 <p>I Il filtro è posizionato nell'abitacolo dietro il vano portaoggetti GB The filter is located in the passenger compartment behind the glove compartment F Le filtre est situé dans l'habitacle derrière la boîte à gants D Der filter befindet sich im Fahrgastraum hinter dem Handshuhfach E El filtro se encuentra en el habitáculo detrás de la guantera</p>					

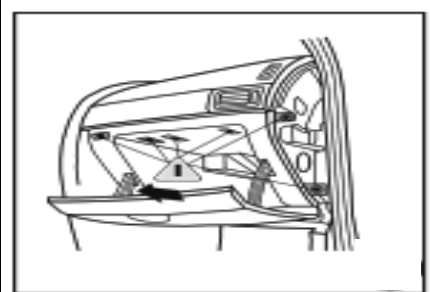
--- Fluence --- with automatic climate control	02/10 ->	*	*	<p>---</p>	<p>CK 10657-10-C 262 x 173 x 35</p>  <p><u>O/E numbers</u> Renault 272773488R / 272778970R</p> <p><u>Cross References</u> Fram CFA10657 Mann CUK26005 Micronair Purflux AHC281 Tecnocar EC498 Fiaam PCK8249</p>
 <p>I Il filtro è posizionato nell'abitacolo dietro il vano portaoggetti GB The filter is located in the passenger compartment behind the glove compartment F Le filtre est situé dans l'habitacle derrière la boîte à gants D Der filter befindet sich im Fahrgastraum hinter dem Handshuhfach E El filtro se encuentra en el habitáculo detrás de la guantera</p>					



Anti-pollen

Activated carbon

RENAULT

--- Kangoo ---

10/97 -> *

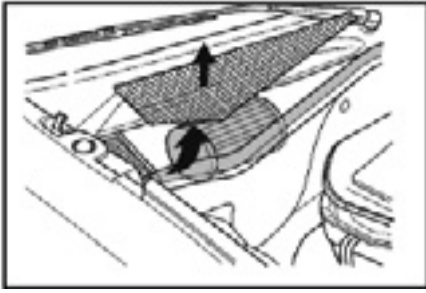

- I** Il filtro è posizionato nel vano motore
- GB** The filter is located in the engine compartment
- F** Le filtre est situé dans le compartiment moteur
- D** Der Filter befindet sich im Motorraum
- E** El filtro se encuentra en el compartimiento del motor

CK 9742

Ø145/99 H 199



O/E numbers

Renault 7701042499

Cross References

Fram CF9742 Mann CU1546
Micronair..... Purflux AH141
Tecocar E342 Fiaam PC8132

--- Kangoo ---

10/97 -> *



- I** Il filtro è posizionato nel vano motore
- GB** The filter is located in the engine compartment
- F** Le filtre est situé dans le compartiment moteur
- D** Der Filter befindet sich im Motorraum
- E** El filtro se encuentra en el compartimiento del motor

CK 8838

229 x 159 x 30



O/E numbers

Renault 7700424098

Cross References

Fram CF8838 Mann CU2945
Micronair MP033 Purflux AH143
Tecocar E344 Fiaam PC8059

CK 8838-C

229 x 159 x 30



O/E numbers

Renault 7711228912

Cross References

Fram CFA8838 Mann CUK2945
Micronair MC533 Purflux AHC143
Tecocar EC344 Fiaam PCK8059

--- Kango II ---

02/08 ->

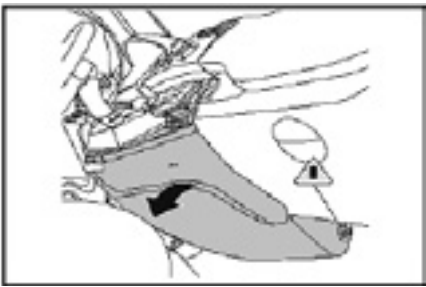

- I** Il filtro è posizionato nell'abitacolo dietro il vano portaoggetti
- GB** The filter is located in the passenger compartment behind the glove compartment
- F** Le filtre est situé dans l'habitacle derrière la boîte à gants
- D** Der filter befindet sich im Fahrgastraum hinter dem Handsuhfach
- E** El filtro se encuentra en el habitáculo detrás de la guantera

CK 10534-2

239 x 108 x 20



O/E numbers

Renault 7701209837

Cross References

Fram CF10534-2 Mann CU2418-2
Micronair MP276-2 Purflux AH273
Tecocar E487-2 Fiaam PC8217-2

CK 10534-C-2

239 x 108 x 20

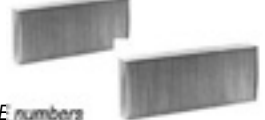

O/E numbers

Renault

Cross References

Fram..... Mann.....
Micronair..... Purflux AHC273
Tecocar..... Fiaam.....

--- Koleos ---

09/08 -> *

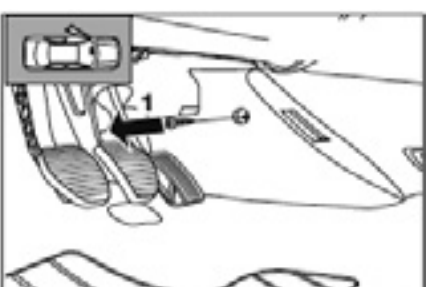

- I** Il filtro è posizionato nell'abitacolo sul lato conducente
- GB** The filter is located in the passenger compartment on the driver's side
- F** Le filtre est situé dans l'habitacle du côté conducteur
- D** Der Filter befindet sich im Fahrgastraum auf der Fahrerseite
- E** El Filtro se encuentra en el habitáculo, del lado del conductor

CK 2620-C

248 x 181 x 20



O/E numbers

Renault 272770840R / 272774658R

Cross References

Fram Mann CUK2620
Micronair MC878 Purflux AHC274
Tecocar E493 Fiaam

--- Laguna I ---

11/93 -> 03/01 *

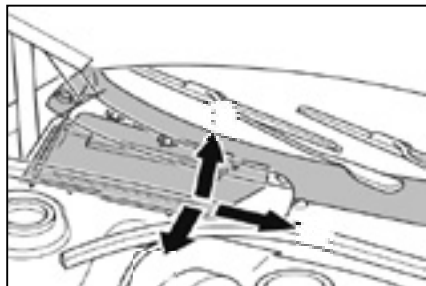

- I** Il filtro è posizionato nel vano motore sul lato passeggero
- GB** The filter is located in the engine compartment on the passenger's side
- F** Le filtre est situé dans le compartiment moteur du côté passager
- D** Der filter befindet sich im Motorraum auf der Beifahrerseite
- E** El filtro se encuentra en el compartimiento del motor, del lado del acompañante

CK 5848

240/230 x 180/170 x 17



O/E numbers

Renault 7700834816

Cross References

Fram CF5848 Mann CU2525
Micronair MP051 Purflux AH117
Tecocar E320 Fiaam PC8022

CK 5848-C

240/230 x 180/170 x 17



O/E numbers

Renault 7711228920

Cross References

Fram CFA5848 Mann CUK2525.
Micronair..... Purflux AHC117
Tecocar EC320 Fiaam PCK8022



Anti-pollen

Activated carbon

RENAULT

--- Laguna II ---

11/00 ->

*

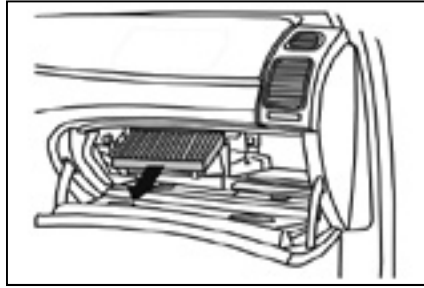

- I** Il filtro è posizionato nell'abitacolo dietro il vano portaoggetti
- GB** The filter is located in the passenger compartment behind the glove compartment
- F** Le filtre est situé dans l'habitacle derrière la boîte à gants
- D** Der filter befindet sich im Fahrgastraum hinter dem Handsuhfach
- E** El filtro se encuentra en el habitáculo detrás de la guantera

CK 9364

211 x 210 x 30



O/E numbers

Renault 7701048748

Cross References

Fram CF9364 Mann CU2149
Micronair MP064 Purflux AH185
Tecocar E388 Fiaam PC8084

CK 9364-C

211 x 210 x 30



O/E numbers

Renault 7701048749

Cross References

Fram CFA9364 Mann CUK2149
Micronair MC564 Purflux AHC185
Tecocar EC388 Fiaam PCK8084

--- Laguna III ---

10/07 ->

*

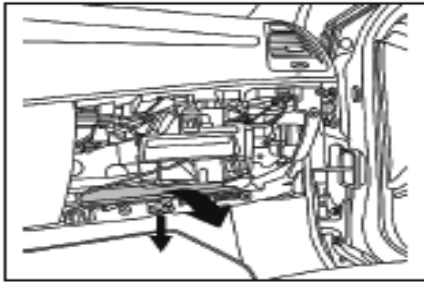

- I** Il filtro è posizionato nell'abitacolo dietro il vano portaoggetti
- GB** The filter is located in the passenger compartment behind the glove compartment
- F** Le filtre est situé dans l'habitacle derrière la boîte à gants
- D** Der filter befindet sich im Fahrgastraum hinter dem Handsuhfach
- E** El filtro se encuentra en el habitáculo detrás de la guantera

CK 10474-2

265 x 132 x 30



O/E numbers

Renault.....

Cross References

Fram..... Mann.....
Micronair MP336-2 Purflux.....
Tecocar..... Fiaam.....

CK 10474-C-2

265 x 132 x 30



O/E numbers

Renault 272770001R

Cross References

Fram CFA10474-2 Mann CUK2723-2
Micronair MC836-2 Purflux AHC264
Tecocar EC477-2 Fiaam PCK8208-2

--- Master IV ---

04/10 ->

*

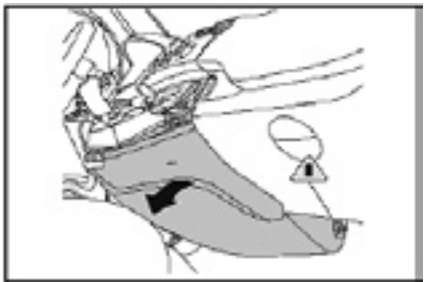

- I** Il filtro è posizionato nell'abitacolo dietro il vano portaoggetti
- GB** The filter is located in the passenger compartment behind the glove compartment
- F** Le filtre est situé dans l'habitacle derrière la boîte à gants
- D** Der filter befindet sich im Fahrgastraum hinter dem Handsuhfach
- E** El filtro se encuentra en el habitáculo detrás de la guantera

CK 10534-2

239 x 108 x 20



O/E numbers

Renault 7701209837

Cross References

Fram CF10534-2 Mann CU2418-2
Micronair MP276-2 Purflux AH273
Tecocar E487-2 Fiaam PC8217-2

CK 10534-C-2

239 x 108 x 20

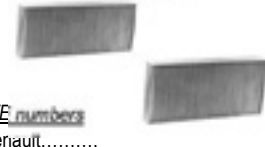

O/E numbers

Renault.....

Cross References

Fram..... Mann.....
Micronair..... Purflux.....
Tecocar..... Fiaam.....

--- Megane I ---

01/96 -> 03/98

*

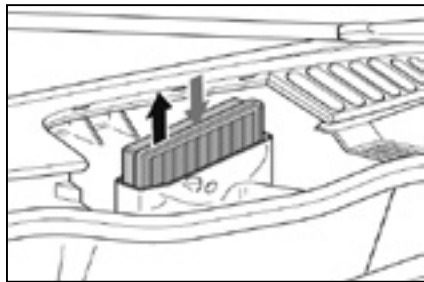

- I** Il filtro è posizionato nel vano motore al centro
- GB** The filter is located in the engine compartment centrally
- F** Le filtre est situé dans le compartiment moteur au centre
- D** Der Filter befindet sich im Motorraum mittig
- E** El filtro se encuentra en el compartimiento del motor, en el centro

CK 9545

290 x 183 x 18



O/E numbers

Renault 7700845811 / 7701205278

Cross References

Fram CF9545 Mann CU3032
Micronair MP052 Purflux AH116
Tecocar E319 Fiaam PC8023/PC8102

--- Megane I ---

04/98 ->

*



- I** Il filtro è posizionato nel vano motore sul lato passeggero sotto il coperchio della vaschetta del radiatore
- GB** The filter is located in the engine compartment on the passenger's side under the radiator tank cover
- F** Le filtre est situé dans le compartiment moteur du côté passager en dessous du cache du réservoir à eau
- D** Der filter befindet sich Motorraum auf der Beifahrerseite unter der Wasserkastenabdeckung
- E** El filtro se encuentra en el compartimiento del motor, lado del acompañante, bajo la cubierta del depósito del agua

CK 8838

229 x 159 x 30



O/E numbers

Renault 7700424098

Cross References

Fram CF8838 Mann CU2945
Micronair MP033 Purflux AH143
Tecocar E344 Fiaam PC8059

CK 8838-C

229 x 159 x 30



O/E numbers

Renault 7711228912

Cross References

Fram CFA8838 Mann CUK2945
Micronair MC533 Purflux AHC143
Tecocar EC344 Fiaam PCK8059



Anti-pollen

Activated carbon

RENAULT

--- Megane I ---

04/98 -> *

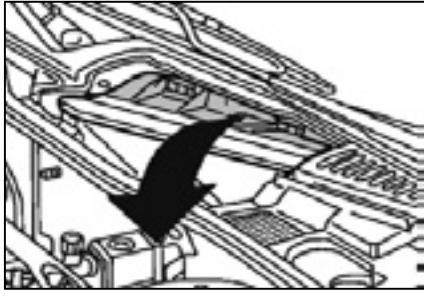

- I** Il filtro è posizionato nel vano motore al centro
- GB** The filter is located in the engine compartment centrally
- F** Le filtre est situé dans le compartiment moteur au centre
- D** Der Filter befindet sich im Motorraum mittig
- E** El filtro se encuentra en el compartimiento del motor, en el centro

CK 5893

256 x 189 x 17



O/E numbers

Renault 7700424093

Cross References

Fram CF5893 Mann CU2424
 Micronair MP084 Purflux AH150
 Tecocar E348 Fiaam PC8030

CK 5893-C

256 x 189 x 17



O/E numbers

Renault 7711228914

Cross References

Fram CFA5893 Mann CUK2424
 Micronair MC584 Purflux AHC150
 Tecocar EC348 Fiaam PCK8030

--- Megane II ---

10/02 -> *

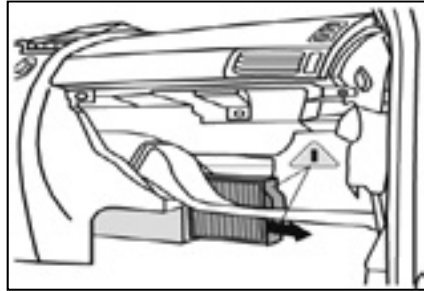

- I** Il filtro è posizionato nell'abitacolo dietro il vano portaoggetti
- GB** The filter is located in the passenger compartment behind the glove compartment
- F** Le filtre est situé dans l'habitacle derrière la boîte à gants
- D** Der filter befindet sich im Fahrgastraum hinter dem Handsuhfach
- E** El filtro se encuentra en el habitáculo detrás de la guantera

CK 9442

269/257 x 186/180 x 30/42,5

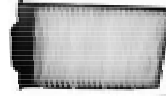

O/E numbers

Renault 7701055109

Cross References

Fram CF9442 Mann CU2316
 Micronair MP167 Purflux AH199
 Tecocar E401 Fiaam PC8111

CK 9442-C

269/257 x 186/180 x 30/42,5



O/E numbers

Renault 7701064235

Cross References

Fram CFA9442 Mann CUK2316
 Micronair MC667 Purflux AHC199
 Tecocar EC401 Fiaam PCK8111

--- Megane III ---

11/08 ->

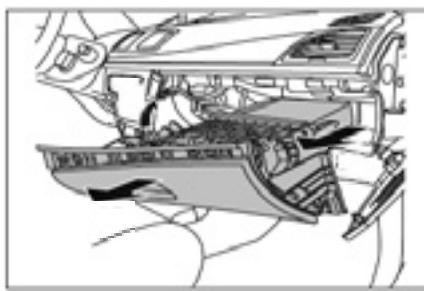

- I** Il filtro è posizionato nell'abitacolo dietro il vano portaoggetti
- GB** The filter is located in the passenger compartment behind the glove compartment
- F** Le filtre est situé dans l'habitacle derrière la boîte à gants
- D** Der filter befindet sich im Fahrgastraum hinter dem Handsuhfach
- E** El filtro se encuentra en el habitáculo detrás de la guantera

CK 10657-10-C

262 x 173 x 35



O/E numbers

Renault 272778970R

Cross References

Fram CFA10657 Mann CUK26005
 Micronair Purflux AHC281
 Tecocar EC498 Fiaam PCK8249

--- Megane CC ---

06/10 ->

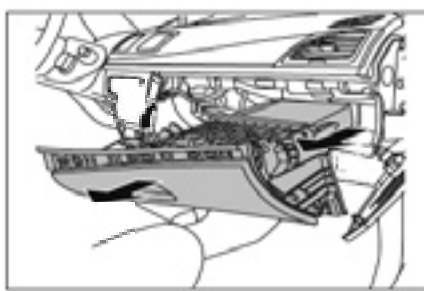

- I** Il filtro è posizionato nell'abitacolo dietro il vano portaoggetti
- GB** The filter is located in the passenger compartment behind the glove compartment
- F** Le filtre est situé dans l'habitacle derrière la boîte à gants
- D** Der filter befindet sich im Fahrgastraum hinter dem Handsuhfach
- E** El filtro se encuentra en el habitáculo detrás de la guantera

CK 10657-10-C

262 x 173 x 35

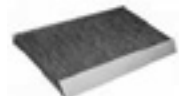

O/E numbers

Renault 272778970R

Cross References

Fram CFA10657 Mann CUK26005
 Micronair Purflux AHC281
 Tecocar EC498 Fiaam PCK8249

--- Modus ---

12/04 ->

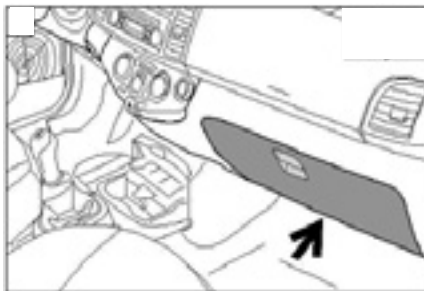

- I** Il filtro è posizionato nell'abitacolo sotto il vano portaoggetti
- GB** The filter is located in the passenger compartment under the glove compartment
- F** Le filtre est situé dans l'habitacle en dessous de la boîte à gants
- D** Der filter befindet sich im Fahrgastraum unter dem Handsuhfach
- E** El filtro se encuentra en el habitáculo, bajo la guantera in de passagieruimte

CK 9691

205 x 181,5 x 27,5/42



O/E numbers

Renault 7701059997 / 7701062227

Cross References

Fram CF9691 Mann CU1829
 Micronair MP179 Purflux AH207
 Tecocar E411 Fiaam PC8128



Anno di fabbricazione / Year of construction
 Année de fabrication / Baujahr / Año de fabricació



Con climatizzatore / With air-conditioning / Avec climatisation
 Mit Klimaanlage / Con instalación de aire acondicionado





Senza climatizzatore / Without air-conditioning / Sans climatisation
 Ohne Klimaanlage / Sin instalación de aire acondicionado





Anti-pollen

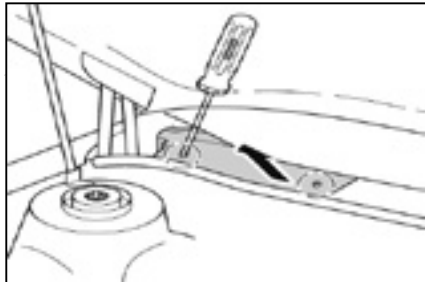

Activated carbon

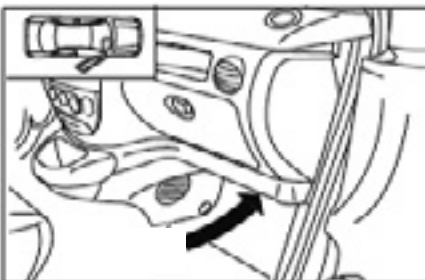

RENAULT

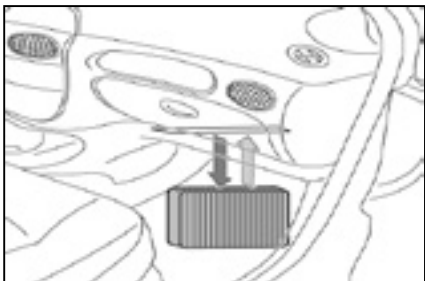
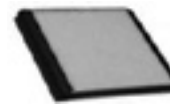
--- Safrane ---	04/92 -> 07/96	*		CK 5847	---
	<p>I Il filtro è posizionato nel vano motore sul lato passeggero</p> <p>GB The filter is located in the engine compartment on the passenger's side</p> <p>F Le filtre est situé dans le compartiment moteur du côté passager</p> <p>D Der filter befindet sich Motorraum auf der Beifahrerseite</p> <p>E El filtro se encuentra en el compartimiento del motor, del lado del acompañante</p>	242/233 x 200/190 x 25		<p><u>O/E numbers</u> Renault 7701418727</p> <p><u>Cross References</u> Fram CF5847 Mann CU2531 Micronair MP035 Purflux AH118 Tecnocar E321 Fiaam PC8021</p>	---

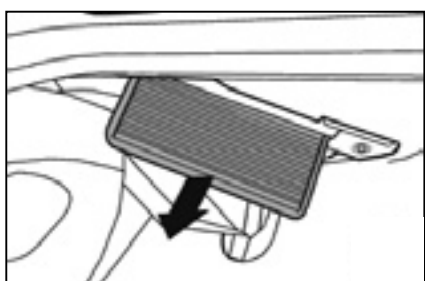
--- Scenic I ---	01/97 -> 09/99	*		CK 9546	---
	<p>I Il filtro è posizionato nell'abitacolo dietro il vano portaoggetti</p> <p>GB The filter is located in the passenger compartment behind the glove compartment</p> <p>F Le filtre est situé dans l'habitacle derrière la boîte à gants</p> <p>D Der filter befindet sich im Fahrgastraum hinter dem Handshuhfach</p> <p>E El filtro se encuentra en el habitáculo detrás de la guantera</p>	281 x 206 x 18		<p><u>O/E numbers</u> Renault 7700845219 / 7701205279</p> <p><u>Cross References</u> Fram CF9546 Mann CU2930 Micronair MP357 Purflux AH132 Tecnocar E331 Fiaam PC8061</p>	---

--- Scenic I ---	01/97 -> 09/99	*		CK 8799	---
	<p>I Il filtro è posizionato nell'abitacolo sotto il vano portaoggetti</p> <p>GB The filter is located in the passenger compartment under the glove compartment</p> <p>F Le filtre est situé dans l'habitacle en dessous de la boîte à gants</p> <p>D Der filter befindet sich im Fahrgastraum unter dem Handshuhfach</p> <p>E El filtro se encuentra en el habitáculo, bajo la guantera in de pasajerruimte</p>	253/249 x 228/218 x 19		<p><u>O/E numbers</u> Renault 7700428820</p> <p><u>Cross References</u> Fram CF8799 Mann CU2435/CU2734 Micronair MP065 Purflux AH133/AH144 Tecnocar E332/E345 Fiaam PC8038</p>	---

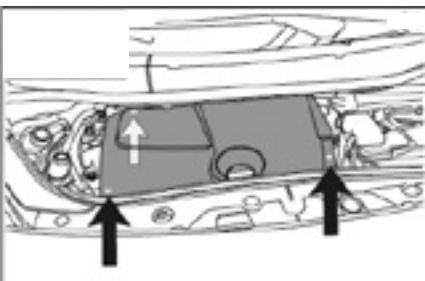
--- Scenic I ---	08/99 -> 06/03	*		CK 9293	CK 9293-C
	<p>I Il filtro è posizionato nell'abitacolo sotto il vano portaoggetti</p> <p>GB The filter is located in the passenger compartment under the glove compartment</p> <p>F Le filtre est situé dans l'habitacle en dessous de la boîte à gants</p> <p>D Der filter befindet sich im Fahrgastraum unter dem Handshuhfach</p> <p>E El filtro se encuentra en el habitáculo, bajo la guantera in de pasajerruimte</p>	230 x 195 x 30		230 x 195 x 30	
<p><u>O/E numbers</u> Renault 770147513</p> <p><u>Cross References</u> Fram CF9293 Mann CU2240 Micronair MP088 Purflux AH169 Tecnocar E365 Fiaam PC8075</p>	<p><u>O/E numbers</u> Renault 7711228919</p> <p><u>Cross References</u> Fram CFA9931 Mann CUK2240 Micronair MC588 Purflux AHC169 Tecnocar EC365 Fiaam PCK8157</p>				

--- Scenic II ---	06/03 ->	*		CK 10067	CK 10067-C
	<p>I Il filtro è posizionato nel vano motore</p> <p>GB The filter is located in the engine compartment</p> <p>F Le filtre est situé dans le compartiment moteur</p> <p>D Der Filter befindet sich im Motorraum</p> <p>E El filtro se encuentra en el compartimiento del motor</p>	216 x 237 x 39,5/47,5		238/216 x 237/230 x 39,5/47,5	
<p><u>O/E numbers</u> Renault 770105510</p> <p><u>Cross References</u> Fram CF10067 Mann CU2430 Micronair MP304 Purflux AH234 Tecnocar E439 Fiaam PC8164</p>	<p><u>O/E numbers</u> Renault 7711060012</p> <p><u>Cross References</u> Fram CFA10067 Mann CUK2430 Micronair..... Purflux AHC234 Tecnocar EC439 Fiaam PCK8164</p>				



Anti-pollen

Activated carbon

RENAULT

--- Scenic III ---

04/09 ->

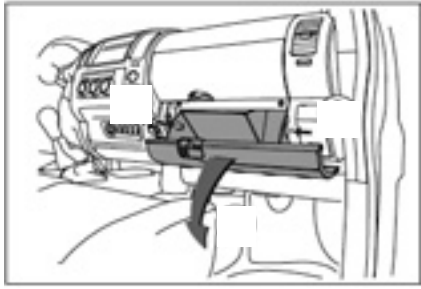

- I** Il filtro è posizionato nell'abitacolo dietro il vano portaoggetti
- GB** The filter is located in the passenger compartment behind the glove compartment
- F** Le filtre est situé dans l'habitacle derrière la boîte à gants
- D** Der filter befindet sich ihm Fahrgastraum hinter dem Handshuhfach
- E** El filtro se encuentra en el habitáculo detrás de la guantera

CK 27001-C
263 x 196 x 38



O/E numbers
Opel 272771128R / 272778859R
Cross References
Fram CFA10761 Mann CUK27001
Micronair MC907 Purflux AHC284
Tecocar EC601 Fiaam PCK8253

--- Scenic RX4 ---

09/99 -> 08/03 *

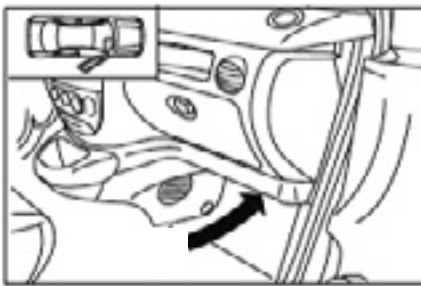

- I** Il filtro è posizionato nell'abitacolo dietro il vano portaoggetti
- GB** The filter is located in the passenger compartment behind the glove compartment
- F** Le filtre est situé dans l'habitacle derrière la boîte à gants
- D** Der filter befindet sich ihm Fahrgastraum hinter dem Handshuhfach
- E** El filtro se encuentra en el habitáculo detrás de la guantera

CK 9546
281 x 206 x 18



O/E numbers
Renault 7700845219 / 7701205279
Cross References
Fram CF9546 Mann CU2930
Micronair MP357 Purflux AH132
Tecocar E331 Fiaam PC8061

--- Scenic RX4 ---

09/99 -> 08/03 *

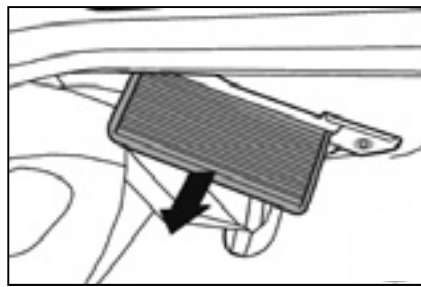

- I** Il filtro è posizionato nell'abitacolo sotto il vano portaoggetti
- GB** The filter is located in the passenger compartment under the glove compartment
- F** Le filtre est situé dans l'habitacle en dessous de la boîte à gants
- D** Der filter befindet sich ihm Fahrgastraum unter dem Handshuhfach
- E** El filtro se encuentra en el habitáculo, bajo la guantera in de passagjeriurimte

CK 9293
230 x 195 x 30

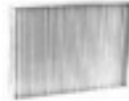

O/E numbers
Renault 770147513
Cross References
Fram CF9293 Mann CU2240
Micronair MP088 Purflux AH169
Tecocar E365 Fiaam PC8075

CK 9293-C
230 x 195 x 30



O/E numbers
Renault 7711228919
Cross References
Fram CFA9931 Mann CUK2240
Micronair MC588 Purflux AHC169
Tecocar EC365 Fiaam PCK8157

--- Symbol ---

09/08 -> *



- I** Il filtro è posizionato nel vano motore sul lato passeggero sotto il coperchio della vaschetta del radiatore
- GB** The filter is located in the engine compartment on the passenger's side under the radiator tank cover
- F** Le filtre est situé dans le compartiment moteur du côté passager en dessous du cache du réservoir à eau
- D** Der filter befindet sich Motorraum auf der Beifahrerseite unter der Wasserkastenabdeckung
- E** El filtro se encuentra en el compartimiento del motor, lado del acompañante, bajo la cubierta del depósito del agua

CK 8838
229 x 159 x 30



O/E numbers
Renault 7700424098
Cross References
Fram CF8838 Mann CU2945
Micronair MP033 Purflux AH143
Tecocar E344 Fiaam PC8059

CK 8838-C
229 x 159 x 30

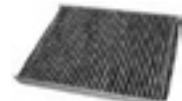

O/E numbers
Renault 7711228912
Cross References
Fram CFA8838 Mann CUK2945
Micronair MC533 Purflux AHC143
Tecocar EC344 Fiaam PCK8059

--- Thalia I ---

03/98 -> 08/08 *



- I** Il filtro è posizionato nel vano motore sul lato passeggero sotto il coperchio della vaschetta del radiatore
- GB** The filter is located in the engine compartment on the passenger's side under the radiator tank cover
- F** Le filtre est situé dans le compartiment moteur du côté passager en dessous du cache du réservoir à eau
- D** Der filter befindet sich Motorraum auf der Beifahrerseite unter der Wasserkastenabdeckung
- E** El filtro se encuentra en el compartimiento del motor, lado del acompañante, bajo la cubierta del depósito del agua

CK 8838
229 x 159 x 30



O/E numbers
Renault 7700424098
Cross References
Fram CF8838 Mann CU2945
Micronair MP033 Purflux AH143
Tecocar E344 Fiaam PC8059

CK 8838-C
229 x 159 x 30



O/E numbers
Renault 7711228912
Cross References
Fram CFA8838 Mann CUK2945
Micronair MC533 Purflux AHC143
Tecocar EC344 Fiaam PCK8059



Anti-pollen

Activated carbon

RENAULT

--- Thalia II ---

09/08 ->

*



- I** Il filtro è posizionato nel vano motore sul lato passeggero sotto il coperchio della vaschetta del radiatore
- GB** The filter is located in the engine compartment on the passenger's side under the radiator tank cover
- F** Le filtre est situé dans le compartiment moteur du côté passager en dessous du cache du réservoir à eau
- D** Der filter befindet sich Motorraum auf der Beifahrerseite unter der Wasserkastenabdeckung
- E** El filtro se encuentra en el compartimiento del motor, lado del acompañante, bajo la cubierta del depósito del agua

CK 8838

229 x 159 x 30



O/E numbers

Renault 7700424098

Cross References

Fram CF8838 Mann CU2945
Micronair MP033 Purflux AH143
Tecocar E344 Fiaam PC8059

CK 8838-C

229 x 159 x 30



O/E numbers

Renault 7711228912

Cross References

Fram CFA8838 Mann CUK2945
Micronair MC533 Purflux AHC143
Tecocar EC344 Fiaam PCK8059

--- Trafic II ---

03/01 ->

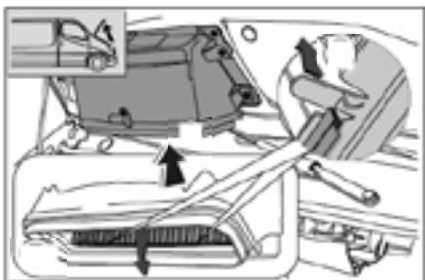

- I** Il filtro è posizionato nel vano motore
- GB** The filter is located in the engine compartment
- F** Le filtre est situé dans le compartiment moteur
- D** Der Filter befindet sich im Motorraum
- E** El filtro se encuentra en el compartimiento del motor

CK 9934

336 x 191/180 x 30/45



O/E numbers

Renault 7701050319

Cross References

Fram CF9934 Mann CU3454
Micronair MP223 Purflux AH186
Tecocar E389 Fiaam PC8154

--- Trafic III ---

07/14 ->

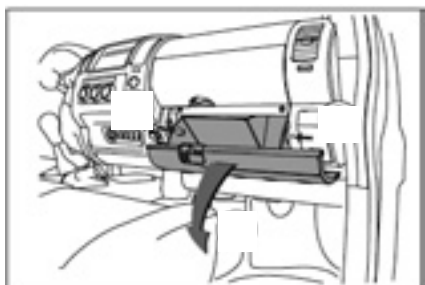

- I** Il filtro è posizionato nell'abitacolo dietro il vano portaoggetti
- GB** The filter is located in the passenger compartment behind the glove compartment
- F** Le filtre est situé dans l'habitacle derrière la boîte à gants
- D** Der filter befindet sich im Fahrgastraum hinter dem Handschuhfach
- E** El filtro se encuentra en el habitáculo detrás de la guantera

CK 27001-C

263 x 196 x 38



O/E numbers

Renault 272771128R / 272778859R

Cross References

Fram CFA10761 Mann CUK27001
Micronair MC907 Purflux AHC284
Tecocar EC601 Fiaam PCK8253

--- Twingo I ---

03/93 -> 05/07

*

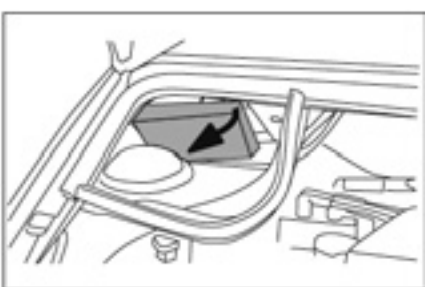

- I** Il filtro è posizionato nel vano motore sul lato passeggero sotto il coperchio della vaschetta del radiatore
- GB** The filter is located in the engine compartment on the passenger's side under the radiator tank cover
- F** Le filtre est situé dans le compartiment moteur du côté passager en dessous du cache du réservoir à eau
- D** Der filter befindet sich Motorraum auf der Beifahrerseite unter der Wasserkastenabdeckung
- E** El filtro se encuentra en el compartimiento del motor, lado del acompañante, bajo la cubierta del depósito del agua

CK 9595

264 x 118 x 31



O/E numbers

Renault 7701409324

Cross References

Fram CF9595 Mann CU2642
Micronair MP062 Purflux AH142
Tecocar E343 Fiaam PC8112

--- Twingo II ---

06/07 ->

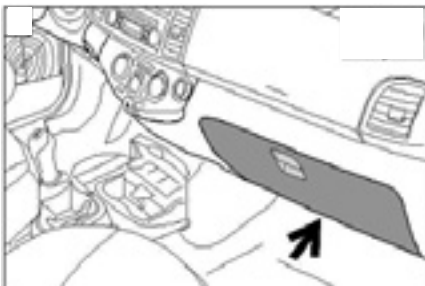

- I** Il filtro è posizionato nell'abitacolo sotto il vano portaoggetti
- GB** The filter is located in the passenger compartment under the glove compartment
- F** Le filtre est situé dans l'habitacle en dessous de la boîte à gants
- D** Der filter befindet sich im Fahrgastraum unter dem Handschuhfach
- E** El filtro se encuentra en el habitáculo, bajo la guantera en el compartimiento de pasajero

CK 9691

205 x 181,5 x 27,5/42



O/E numbers

Renault 7701059997 / 7701062227

Cross References

Fram CF9691 Mann CU1829
Micronair MP179 Purflux AH207
Tecocar E411 Fiaam PC8128



Anti-pollen

Activated carbon

RENAULT

--- Twingo II ---

06/07 ->

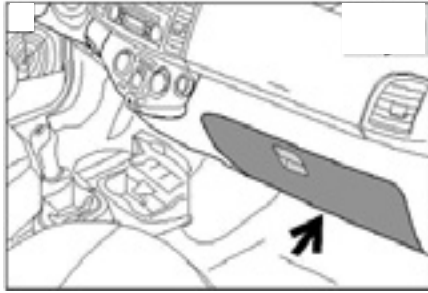

- I** Il filtro è posizionato nell'abitacolo sotto il vano portaoggetti
- GB** The filter is located in the passenger compartment under the glove compartment
- F** Le filtre est situé dans l'habitacle en dessous de la boîte à gants
- D** Der filter befindet sich im Fahrgastraum unter dem Handshuhfach
- E** El filtro se encuentra en el habitáculo, bajo la guantera de pasajerruimte

CK 22021-C

214 x 214 x 25



O/E numbers

Renault 272774711R

Cross References

Fram Mann CUK22021
Micronair Purflux
Tecnocar Fiaam

--- Vel Satis ---

06/02 ->

*

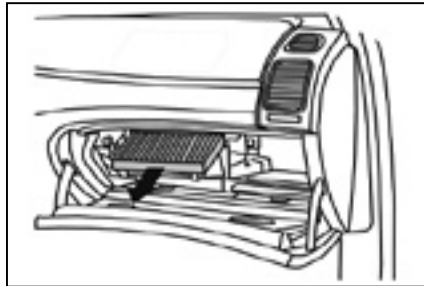

- I** Il filtro è posizionato nell'abitacolo dietro il vano portaoggetti
- GB** The filter is located in the passenger compartment behind the glove compartment
- F** Le filtre est situé dans l'habitacle derrière la boîte à gants
- D** Der filter befindet sich im Fahrgastraum hinter dem Handshuhfach
- E** El filtro se encuentra en el habitáculo detrás de la guantera

CK 9364

211 x 210 x 30



O/E numbers

Renault 7701048748

Cross References

Fram CF9364 Mann CU2149
Micronair MP064 Purflux AH185
Tecnocar E388 Fiaam PC8084

CK 9364-C

211 x 210 x 30



O/E numbers

Renault 7701048749

Cross References

Fram CFA9364 Mann CUK2149
Micronair MC564 Purflux AHC185
Tecnocar EC388 Fiaam PCK8084

--- Wind ---

06/10 ->

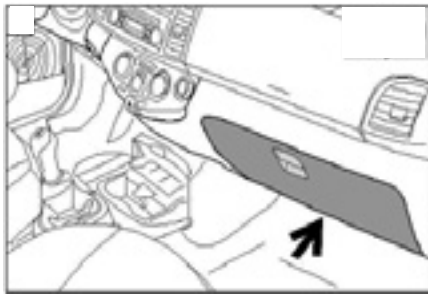

- I** Il filtro è posizionato nell'abitacolo sotto il vano portaoggetti
- GB** The filter is located in the passenger compartment under the glove compartment
- F** Le filtre est situé dans l'habitacle en dessous de la boîte à gants
- D** Der filter befindet sich im Fahrgastraum unter dem Handshuhfach
- E** El filtro se encuentra en el habitáculo, bajo la guantera de pasajerruimte

CK 9691

205 x 181,5 x 27,5/42



O/E numbers

Renault 7701059997 / 7701062227

Cross References

Fram CF9691 Mann CU1829
Micronair MP179 Purflux AH207
Tecnocar E411 Fiaam PC8128

--- Zoe ---

06/12 ->

*

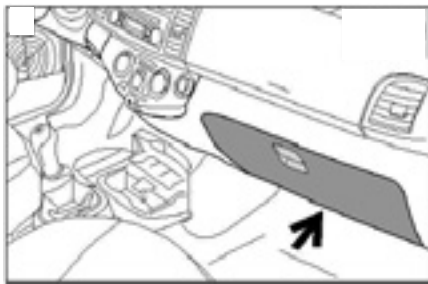

- I** Il filtro è posizionato nell'abitacolo sotto il vano portaoggetti
- GB** The filter is located in the passenger compartment under the glove compartment
- F** Le filtre est situé dans l'habitacle en dessous de la boîte à gants
- D** Der filter befindet sich im Fahrgastraum unter dem Handshuhfach
- E** El filtro se encuentra en el habitáculo, bajo la guantera de pasajerruimte

CK 25012

249 x 180 x 35



O/E numbers

Renault 272775340R

Cross References

Fram CF11544 Mann CU25012
Micronair MP427 Purflux AH386
Tecnocar E678 Fiaam PC8355

CK 25012-C

249 x 180 x 35



O/E numbers

Renault 272775081R



Cross References

Fram CFA11544 Mann CUK25012
Micronair MC927 Purflux AHC386
Tecnocar EC678 Fiaam PCK8355

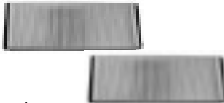
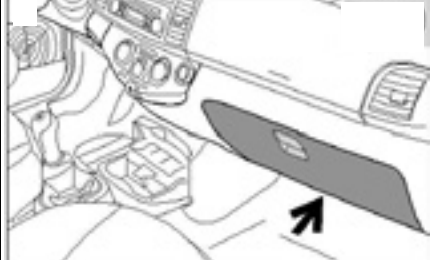

ROLLS-ROYCE

--- Dawn ---	09/15 ->	*		<p>CK 2533-2 245 x 206 x 32</p>  <p><u>O/E numbers</u> Bmw 64119163328 / 64119272641</p> <p><u>Cross References</u> Fram CF11220-2 Mann CU2533-2 Micronair MP380-2 Puflex AH336-2 Tecnocar E629-2 Fiaam PC8293-2</p>	---
 <p>I Il filtro è posizionato nell'abitacolo sotto il vano portaoggetti</p> <p>GB The filter is located in the passenger compartment under the glove compartment</p> <p>F Le filtre est situé dans l'habitacle en dessous de la boîte à gants</p> <p>D Der filter befindet sich im Fahrgastraum unter dem Handshuhfach</p> <p>E El filtro se encuentra en el habitáculo, bajo la guantera de pasajerruimte</p>					

--- Ghost ---	11/09 ->	*		<p>CK 2533-2 245 x 206 x 32</p>  <p><u>O/E numbers</u> Bmw 64119163328 / 64119272641</p> <p><u>Cross References</u> Fram CF11220-2 Mann CU2533-2 Micronair MP380-2 Puflex AH336-2 Tecnocar E629-2 Fiaam PC8293-2</p>	---
 <p>I Il filtro è posizionato nell'abitacolo sotto il vano portaoggetti</p> <p>GB The filter is located in the passenger compartment under the glove compartment</p> <p>F Le filtre est situé dans l'habitacle en dessous de la boîte à gants</p> <p>D Der filter befindet sich im Fahrgastraum unter dem Handshuhfach</p> <p>E El filtro se encuentra en el habitáculo, bajo la guantera de pasajerruimte</p>					

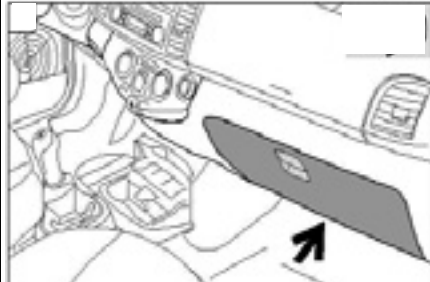
--- Wraith ---	11/12 ->	*		<p>CK 2533-2 245 x 206 x 32</p>  <p><u>O/E numbers</u> Bmw 64119163328 / 64119272641</p> <p><u>Cross References</u> Fram CF11220-2 Mann CU2533-2 Micronair MP380-2 Puflex AH336-2 Tecnocar E629-2 Fiaam PC8293-2</p>	---
 <p>I Il filtro è posizionato nell'abitacolo sotto il vano portaoggetti</p> <p>GB The filter is located in the passenger compartment under the glove compartment</p> <p>F Le filtre est situé dans l'habitacle en dessous de la boîte à gants</p> <p>D Der filter befindet sich im Fahrgastraum unter dem Handshuhfach</p> <p>E El filtro se encuentra en el habitáculo, bajo la guantera de pasajerruimte</p>					

--	--	--

--	--	--



Anti-pollen

Activated carbon

ROVER

--- MG ZR ---

09/01 -> 04/05

*

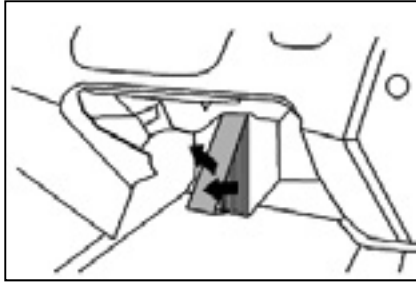

- Il filtro è posizionato nell'abitacolo dietro il vano portaoggetti
- The filter is located in the passenger compartment behind the glove compartment
- Le filtre est situé dans l'habitacle derrière la boîte à gants
- Der filter befindet sich im Fahrgastraum hinter dem Handshuhfach
- El filtro se encuentra en el habitáculo detrás de la guantera

CK 9338

224 x 198,5 x 30



O/E numbers

Rover JKR100020 / JKY100020

Cross References

Fram CF9338 Mann CU2351/CU2520
Micronair MP080/MP232 Purflux AH165
Tecnocar E362 Fiaam PC8080

--- MG ZS --- -> Chassis no.WD354434

09/01 -> 10/05

*

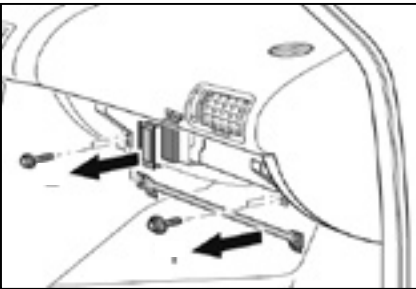

- Il filtro è posizionato nell'abitacolo dietro il vano portaoggetti
- The filter is located in the passenger compartment behind the glove compartment
- Le filtre est situé dans l'habitacle derrière la boîte à gants
- Der filter befindet sich im Fahrgastraum hinter dem Handshuhfach
- El filtro se encuentra en el habitáculo detrás de la guantera

CK 5865

212 x 210 x 30



O/E numbers

Rover JXK100010

Cross References

Fram CF5865 Mann CU2253
Micronair MP029 Purflux AH127
Tecnocar E328 Fiaam PC8017

--- MG ZS ---

09/01 -> 10/05

*

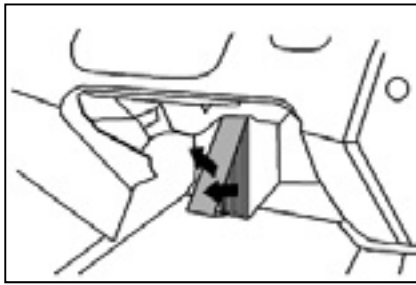

- Il filtro è posizionato nell'abitacolo dietro il vano portaoggetti
- The filter is located in the passenger compartment behind the glove compartment
- Le filtre est situé dans l'habitacle derrière la boîte à gants
- Der filter befindet sich im Fahrgastraum hinter dem Handshuhfach
- El filtro se encuentra en el habitáculo detrás de la guantera

CK 9338

224 x 198,5 x 30



O/E numbers

Rover JKR100020 / JKY100020

Cross References

Fram CF9338 Mann CU2351/CU2520
Micronair MP080/MP232 Purflux AH165
Tecnocar E362 Fiaam PC8080

--- MG ZT ---

06/01 -> 07/05

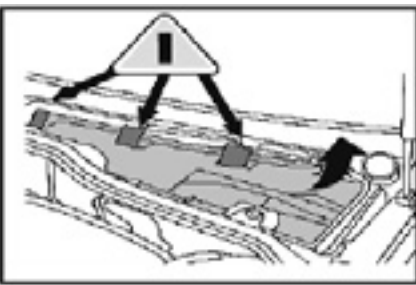

- Il filtro è posizionato nel vano motore sul lato passeggero
- The filter is located in the engine compartment on the passenger's side
- Le filtre est situé dans le compartiment moteur du côté passager
- Der filter befindet sich Motorraum auf der Beifahrerseite
- El filtro se encuentra en el compartimiento del motor, del lado del acompañante

CK 9640

395/385 x 274/252 x 30/33,5



O/E numbers

Rover JKR100183

Cross References

Fram CF9640 Mann CU3943
Micronair MP233 Purflux AH227
Tecnocar E426 Fiaam PC8129

CK 9640-C

395/385 x 274/252 x 30/33,5



O/E numbers

Rover JKR000040 / JKR100193

Cross References

Fram..... Mann CUK3943
Micronair MC733 Purflux.....
Tecnocar..... Fiaam.....

--- MG ZT-T ---

10/01 -> 07/05

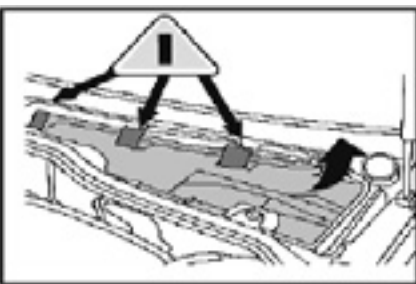

- Il filtro è posizionato nel vano motore sul lato passeggero
- The filter is located in the engine compartment on the passenger's side
- Le filtre est situé dans le compartiment moteur du côté passager
- Der filter befindet sich Motorraum auf der Beifahrerseite
- El filtro se encuentra en el compartimiento del motor, del lado del acompañante

CK 9640

395/385 x 274/252 x 30/33,5



O/E numbers

Rover JKR100183

Cross References

Fram CF9640 Mann CU3943
Micronair MP233 Purflux AH227
Tecnocar E426 Fiaam PC8129

CK 9640-C

395/385 x 274/252 x 30/33,5



O/E numbers



Rover JKR000040 / JKR100193



Cross References

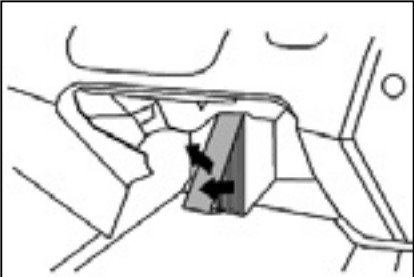

Fram..... Mann CUK3943
Micronair MC733 Purflux.....
Tecnocar..... Fiaam.....



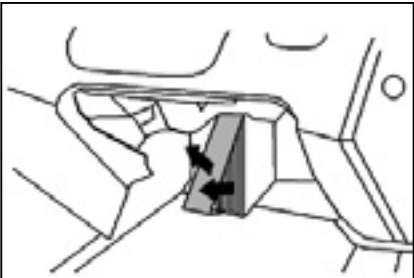

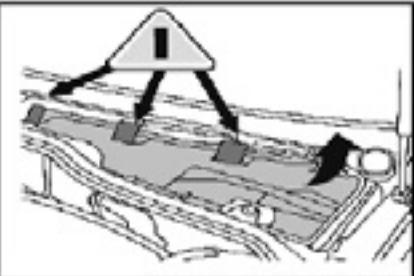

ROVER

<p>--- Rover 25 ---</p> 	<p>10/99 -> * <input type="checkbox"/></p>	<p>CK 9338 224 x 198,5 x 30</p>  <p><u>O/E numbers</u> Rover JKR100020 / JKY100020</p> <p><u>Cross References</u> Fram CF9338 Mann CU2351/CU2520 Micronair MP080/MP232 Purflux AH165 Tecnocar E362 Fiaam PC8080</p>	<p>---</p>
--	---	---	------------

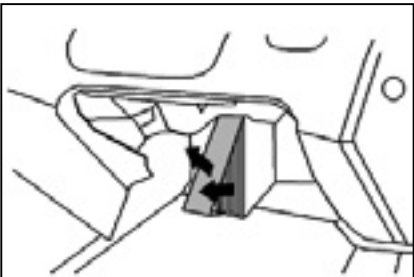
<p>--- Rover 45 ---</p> 	<p>01/00 -> 05/05 * <input type="checkbox"/></p>	<p>CK 9338 224 x 198,5 x 30</p>  <p><u>O/E numbers</u> Rover JKR100020 / JKY100020</p> <p><u>Cross References</u> Fram CF9338 Mann CU2351/CU2520 Micronair MP080/MP232 Purflux AH165 Tecnocar E362 Fiaam PC8080</p>	<p>---</p>
--	---	---	------------

<p>--- Rover 75 ---</p> 	<p>04/99 -> 05/05 <input type="checkbox"/> <input type="checkbox"/></p>	<p>CK 9640 395/385 x 274/252 x 30/33,5</p>  <p><u>O/E numbers</u> Rover JKR100183</p> <p><u>Cross References</u> Fram CF9640 Mann CU3943 Micronair MP233 Purflux AH227 Tecnocar E426 Fiaam PC8129</p>	<p>CK 9640-C 395/385 x 274/252 x 30/33,5</p>  <p><u>O/E numbers</u> Rover JKR000040 / JKR100193</p> <p><u>Cross References</u> Fram..... Mann CUK3943 Micronair MC733 Purflux..... Tecnocar..... Fiaam.....</p>
--	--	---	--

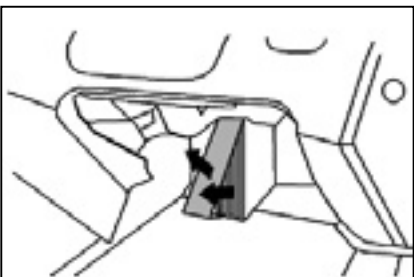
<p>--- Rover 200 ---</p> 	<p>02/98 -> * <input type="checkbox"/></p>	<p>CK 9338 224 x 198,5 x 30</p>  <p><u>O/E numbers</u> Rover JKR100020 / JKY100020</p> <p><u>Cross References</u> Fram CF9338 Mann CU2351/CU2520 Micronair MP080/MP232 Purflux AH165 Tecnocar E362 Fiaam PC8080</p>	<p>---</p>
---	---	---	------------

<p>--- Rover 400 ---</p> 	<p>10/95 -> * <input type="checkbox"/></p>	<p>CK 9338 224 x 198,5 x 30</p>  <p><u>O/E numbers</u> Rover JKR100020 / JKY100020</p> <p><u>Cross References</u> Fram CF9338 Mann CU2351/CU2520 Micronair MP080/MP232 Purflux AH165 Tecnocar E362 Fiaam PC8080</p>	<p>---</p>
---	---	---	------------



Anti-pollen

Activated carbon

ROVER

--- Rover 400 ---

10/95 ->

*

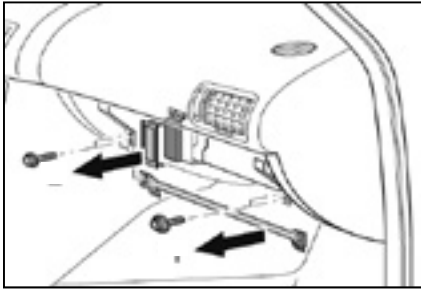

- I** Il filtro è posizionato nell'abitacolo dietro il vano portaoggetti
- GB** The filter is located in the passenger compartment behind the glove compartment
- F** Le filtre est situé dans l'habitacle derrière la boîte à gants
- D** Der filter befindet sich im Fahrgastraum hinter dem Handshuhfach
- E** El filtro se encuentra en el habitáculo detrás de la guantera

CK 5865

212 x 210 x 30



O/E numbers

Rover JKX100010

Cross References

Fram CF5865	Mann CU2253
Micronair MP029	Purflux AH127
Tecnocar E328	Fiaam PC8017

--- Streetwise ---

09/03 ->

*

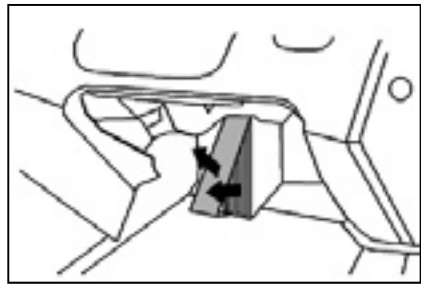

- I** Il filtro è posizionato nell'abitacolo dietro il vano portaoggetti
- GB** The filter is located in the passenger compartment behind the glove compartment
- F** Le filtre est situé dans l'habitacle derrière la boîte à gants
- D** Der filter befindet sich im Fahrgastraum hinter dem Handshuhfach
- E** El filtro se encuentra en el habitáculo detrás de la guantera

CK 9338

224 x 198,5 x 30



O/E numbers









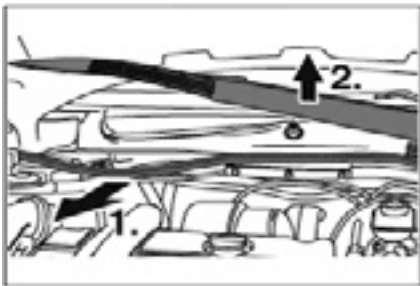

Rover JKR100020 / JKY100020

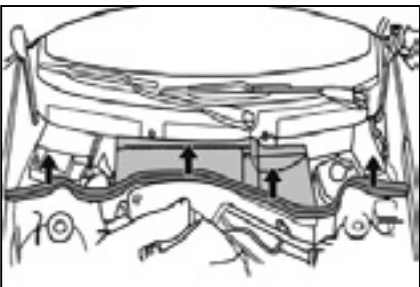
Cross References

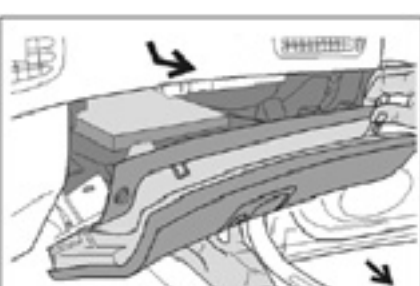
Fram CF9338	Mann CU2351/CU2520
Micronair MP080/MP232	Purflux AH165
Tecnocar E362	Fiaam PC8080

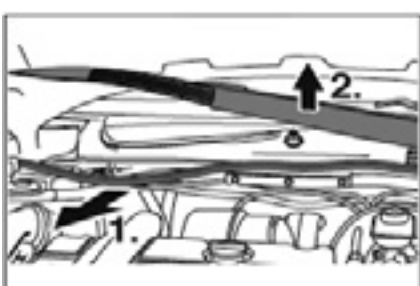

SAAB

<p>--- 9-3 I ---</p>  <p>03/98 -> 08/02</p> <p>Il filtro è posizionato nel vano motore dietro la presa d'aria The filter is located in the engine compartment behind the ventilation grilles Le filtre est situé dans le compartiment moteur derrière les grilles d'aération Der filter befindet sich im Motorraum hinter den Lüftungsgittern El filtro se encuentra en el compartimiento del motor, detrás de la rejilla de ventilación</p>	<p>CK 9724</p> <p>437/385 x 126 x 29/41</p>  <p><u>O/E numbers</u> Saab 4632493 / 5047113</p> <p><u>Cross References</u> Fram CF9724 Mann CU4416 Micronair MP345 Purflux AH228 Tecocar E427 Fiaam PC8130</p>	
<p>--- 9-3 II ---</p>  <p>08/02 -></p> <p>Il filtro è posizionato nel vano motore al centro The filter is located in the engine compartment centrally Le filtre est situé dans le compartiment moteur au centre Der Filter befindet sich im Motorraum mitting El filtro se encuentra en el compartimiento del motor, en el centro</p>	<p>CK 9495</p> <p>332 x 164 x 30</p>  <p><u>O/E numbers</u> Saab 9179905</p> <p><u>Cross References</u> Fram CF9495 Mann CU3337 Micronair MP107 Purflux AH198 Tecocar E400 Fiaam PC8097</p>	<p>CK 9495-C</p> <p>332 x 164 x 30</p>  <p><u>O/E numbers</u> Saab 9179904</p> <p><u>Cross References</u> Fram CFA9495 Mann CUK3337 Micronair MC607/MC694 Purflux AHC198 Tecocar EC400 Fiaam PCK8097</p>
<p>--- 9-5 I ---</p>  <p>09/97 -></p> <p>Il filtro è posizionato nell'abitacolo dietro il vano portaoggetti The filter is located in the passenger compartment behind the glove compartment Le filtre est situé dans l'habitacle derrière la boîte à gants Der filter befindet sich im Fahrgastraum hinter dem Handsuhfach El filtro se encuentra en el habitáculo detrás de la guantera</p>		<p>CK 8778-C</p> <p>327/315 x 206/201 x 44/55</p>  <p><u>O/E numbers</u> Saab 5335948 / 5335955</p> <p><u>Cross References</u> Fram..... Mann CUK3220 Micronair MC689 Purflux..... Tecocar..... Fiaam.....</p>
<p>--- 9-5 II ---</p>  <p>09/10 -></p> <p>Il filtro è posizionato nell'abitacolo dietro il vano portaoggetti The filter is located in the passenger compartment behind the glove compartment Le filtre est situé dans l'habitacle derrière la boîte à gants Der filter befindet sich im Fahrgastraum hinter dem Handsuhfach El filtro se encuentra en el habitáculo detrás de la guantera</p>	<p>CK 10774</p> <p>239 x 204 x 35</p>  <p><u>O/E numbers</u> Saab.....</p> <p><u>Cross References</u> Fram CF10774 Mann CU2442 Micronair MP366 Purflux AH286 Tecocar E603 Fiaam PC8255</p>	<p>CK 10774-C</p> <p>239 x 204 x 35</p>  <p><u>O/E numbers</u> Saab.....</p> <p><u>Cross References</u> Fram CFA10775 Mann CUK2442 Micronair MC866 Purflux AHC286 Tecocar EC603 Fiaam PCK8255</p>
<p>--- 900 I ---</p>  <p>01/91 -> 07/93</p> <p>Il filtro è posizionato nel vano motore dietro la presa d'aria The filter is located in the engine compartment behind the ventilation grilles Le filtre est situé dans le compartiment moteur derrière les grilles d'aération Der filter befindet sich im Motorraum hinter den Lüftungsgittern El filtro se encuentra en el compartimiento del motor, detrás de la rejilla de ventilación</p>	<p>CK 9907</p> <p>290 x 230 x 65</p>  <p><u>O/E numbers</u> Saab 4072427</p> <p><u>Cross References</u> Fram CF9907 Mann CU3080 Micronair..... Purflux AH146 Tecocar E339 Fiaam PC8150</p>	



Anti-pollen

Activated carbon

SAAB

--- 900 II ---

07/93 -> 05/98

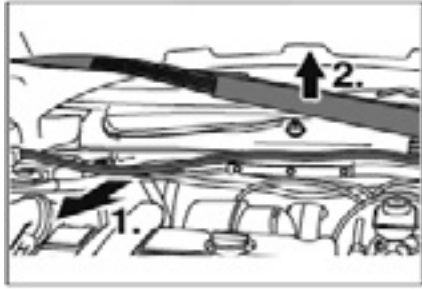

- I** Il filtro è posizionato nel vano motore dietro la presa d'aria
- GB** The filter is located in the engine compartment behind the ventilation grilles
- F** Le filtre est situé dans le compartiment moteur derrière les grilles d'aération
- D** Der filter befindet sich im Motorraum hinter den Lüftungsgittern
- E** El filtro se encuentra en el compartimiento del motor, detrás de la rejilla de ventilación

CK 9724

437/385 x 126 x 29/41



O/E numbers

Saab 4632493 / 5047113

Cross References

Fram CF9724 Mann CU4416
 Micronair MP345 Purflux AH228
 Tecnocar E427 Fiaam PC8130

--- 9000 ---

09/84 -> 09/91

*

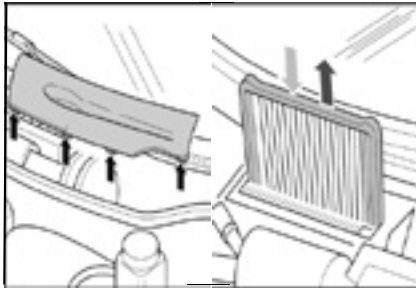

- I** Il filtro è posizionato nel vano motore
- GB** The filter is located in the engine compartment
- F** Le filtre est situé dans le compartiment moteur
- D** Der Filter befindet sich im Motorraum
- E** El filtro se encuentra en el compartimiento del motor

CK 5841

286 x 224 x 13



O/E numbers

Saab 9625674

Cross References

Fram CF5841 Mann CU3136
 Micronair MP027 Purflux AH109
 Tecnocar E304 Fiaam PC8008





Anti-pollen

Activated carbon

SEAT

--- Alhambra I ---

04/96 -> 08/10

*

*

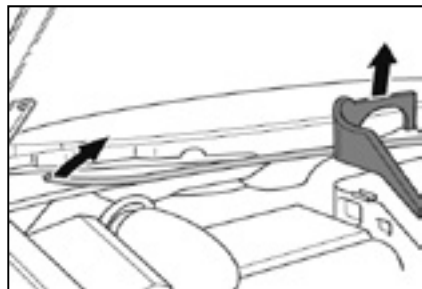

- I** Il filtro è posizionato nel vano motore sul lato passeggero
- GB** The filter is located in the engine compartment on the passenger's side
- F** Le filtre est situé dans le compartiment moteur du côté passager
- D** Der filter befindet sich Motorraum auf der Beifahrerseite
- E** El filtro se encuentra en el compartimiento del motor, del lado del acompañante

CK 5850

535 x 109 x 25,5



O/E numbers

V.A.G. 7M0819638A / 7M0819644

Cross References

Fram CF5850 Mann CU5480
Micronair MP025 Purflux AH129
Tecocar E329 Fiaam PC8024

CK 5850-C

535 x 109,5 x 25,5



O/E numbers

V.A.G. 7M0091800SE / 7M3819644A

Cross References

Fram CFA8878 Mann CUK5480
Micronair MC525 Purflux AHC129
Tecocar..... Fiaam PCK8066

--- Alhambra II ---

08/10 ->

*

*

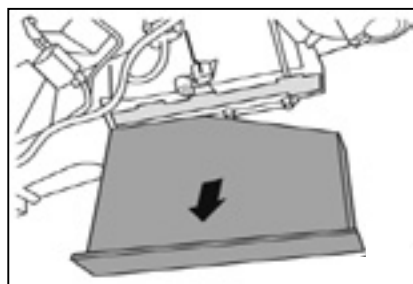

- I** Il filtro è posizionato nell'abitacolo sotto il vano portaoggetti
- GB** The filter is located in the passenger compartment under the glove compartment
- F** Le filtre est situé dans l'habitacle en dessous de la boîte à gants
- D** Der filter befindet sich im Fahrgastraum unter dem Handshuhfach
- E** El filtro se encuentra en el habitáculo, bajo la guanterain de pasajerruimte

CK 9922

286/280 x 214 x 34/57



O/E numbers

V.A.G. 1K0819644 / 1K0819644A

Cross References

Fram CF9922 Mann CU2939
Micronair MP113 Purflux AH202
Tecocar E409 Fiaam PC8155

CK 9922-C

286/280 x 214 x 34/57



O/E numbers

V.A.G. 1K1819653 / 1K1819653A

Cross References

Fram CFA9921 Mann CUK2939
Micronair MC613 Purflux AHC202
Tecocar EC409 Fiaam PCK8155

--- Altea ---

06/04 ->

*

*

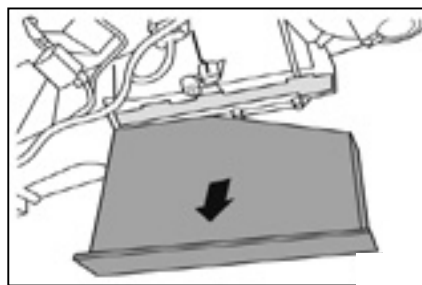

- I** Il filtro è posizionato nell'abitacolo sotto il vano portaoggetti
- GB** The filter is located in the passenger compartment under the glove compartment
- F** Le filtre est situé dans l'habitacle en dessous de la boîte à gants
- D** Der filter befindet sich im Fahrgastraum unter dem Handshuhfach
- E** El filtro se encuentra en el habitáculo, bajo la guanterain de pasajerruimte

CK 9922

286/280 x 214 x 34/57



O/E numbers

V.A.G. 1K0819644 / 1K0819644A

Cross References

Fram CF9922 Mann CU2939
Micronair MP113 Purflux AH202
Tecocar E409 Fiaam PC8155

CK 9922-C

286/280 x 214 x 34/57



O/E numbers

V.A.G. 1K1819653 / 1K1819653A

Cross References

Fram CFA9921 Mann CUK2939
Micronair MC613 Purflux AHC202
Tecocar EC409 Fiaam PCK8155

--- Arosa ---

02/97 ->

*

*

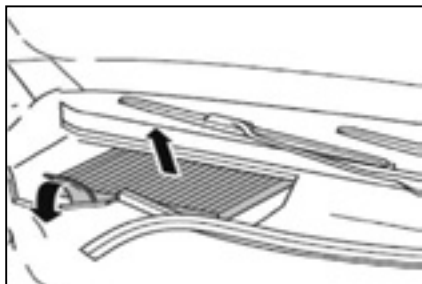

- I** Il filtro è posizionato nel vano motore al centro
- GB** The filter is located in the engine compartment centrally
- F** Le filtre est situé dans le compartiment moteur au centre
- D** Der Filter befindet sich im Motorraum mitting
- E** El filtro se encuentra en el compartimiento del motor, en el centro

CK 5663

280 x 206 x 25



O/E numbers

V.A.G. 1H0819644A / 1H0819638A

Cross References

Fram CF5663 Mann CU2882
Micronair MP044 Purflux AH104
Tecocar E311 Fiaam PC8005

CK 5663-C

280 x 206 x 25



O/E numbers

V.A.G. 1H0091800 / 8L0091800

Cross References

Fram CFA8893 Mann CUK2882
Micronair MC544 Purflux AHC104
Tecocar..... Fiaam PCK8072

--- Cordoba I ---

09/93 -> 06/99

*

*

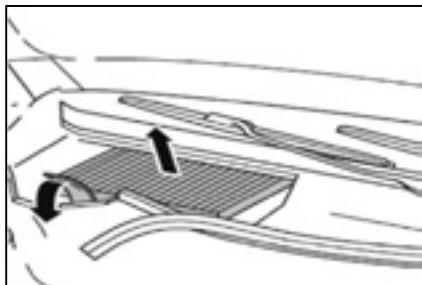

- I** Il filtro è posizionato nel vano motore al centro
- GB** The filter is located in the engine compartment centrally
- F** Le filtre est situé dans le compartiment moteur au centre
- D** Der Filter befindet sich im Motorraum mitting
- E** El filtro se encuentra en el compartimiento del motor, en el centro

CK 5663

280 x 206 x 25



O/E numbers

V.A.G. 1H0819644A / 1H0819638A

Cross References

Fram CF5663 Mann CU2882
Micronair MP044 Purflux AH104
Tecocar E311 Fiaam PC8005

CK 5663-C

280 x 206 x 25



O/E numbers

V.A.G. 1H0091800 / 8L0091800

Cross References

Fram CFA8893 Mann CUK2882
Micronair MC544 Purflux AHC104
Tecocar..... Fiaam PCK8072



Anti-pollen

Activated carbon

SEAT

--- Cordoba II ---

06/99 -> 12/02

*

*

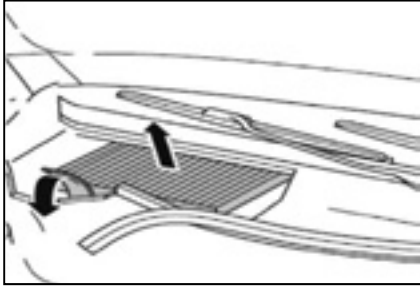

- Il filtro è posizionato nel vano motore al centro
- The filter is located in the engine compartment centrally
- Le filtre est situé dans le compartiment moteur au centre
- Der Filter befindet sich im Motorraum mitting
- El filtro se encuentra en el compartimiento del motor, en el centro

CK 5663

280 x 206 x 25



O/E numbers

V.A.G. 1H0819644A / 1H0819638A

Cross References

Fram CF5663 Mann CU2882
Micronair MP044 Purflux AH104
Tecocar E311 Fiaam PC8005

CK 5663-C

280 x 206 x 25



O/E numbers

V.A.G. 1H0091800 / 8L0091800

Cross References

Fram CFA8893 Mann CUK2882
Micronair MC544 Purflux AHC104
Tecocar..... Fiaam PCK8072

--- Cordoba III ---

10/02 -> 11/09

*

*

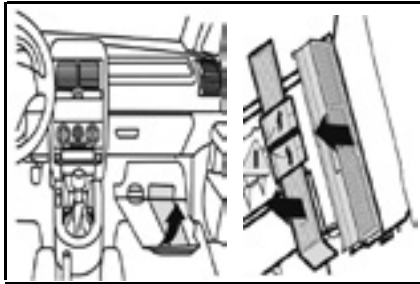

- Il filtro è posizionato nell'abitacolo dietro il vano portaoggetti
- The filter is located in the passenger compartment behind the glove compartment
- Le filtre est situé dans l'habitacle derrière la boîte à gants
- Der filter befindet sich im Fahrgastraum hinter dem Handschuhfach
- El filtro se encuentra en el habitáculo detrás de la guantera

CK 9323

251 x 215 x 32



O/E numbers

V.A.G. 6Q0820367

Cross References

Fram CF9323 Mann CU2545
Micronair MP060 Purflux AH191
Tecocar E394 Fiaam PC8077

CK 9323-C

251 x 215 x 32



O/E numbers

V.A.G. 6Q0819653 / 6Q0820367-S

Cross References

Fram CFA9404 Mann CUK2545
Micronair MC560 Purflux AHC191
Tecocar EC394 Fiaam PCK8092

--- Exeo ---

02/09 ->

*

*

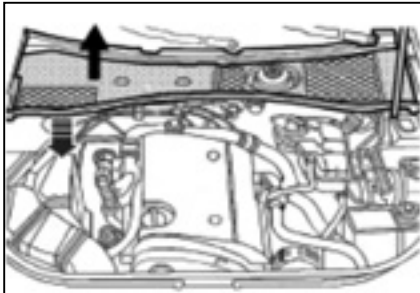

- Il filtro è posizionato nel vano motore sul lato passeggero sotto il coperchio della vaschetta del radiatore
- The filter is located in the engine compartment on the passenger's side under the radiator tank cover
- Le filtre est situé dans le compartiment moteur du côté passager en dessous du cache du réservoir à eau
- Der filter befindet sich Motorraum auf der Beifahrerseite unter der Wasserkastenabdeckung
- El filtro se encuentra en el compartimiento del motor, lado del acompañante, bajo la cubierta del depósito del agua

CK 9645

300 x 204,5 x 30



O/E numbers

V.A.G. 8E0819439

Cross References

Fram CF9645 Mann CU3037
Micronair MP106 Purflux AH184
Tecocar E387 Fiaam PC8117

CK 9645-C

300 x 204,5 x 30



O/E numbers

V.A.G. 4B0819439C

Cross References

Fram CFA9548 Mann CUK3037
Micronair MC606 Purflux AHC184
Tecocar EC387 Fiaam PCK8103

--- Ibiza II ---

09/93 -> 08/99

*

*

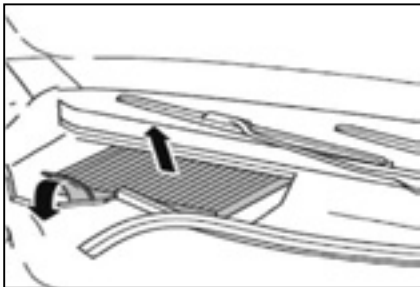

- Il filtro è posizionato nel vano motore al centro
- The filter is located in the engine compartment centrally
- Le filtre est situé dans le compartiment moteur au centre
- Der Filter befindet sich im Motorraum mitting
- El filtro se encuentra en el compartimiento del motor, en el centro

CK 5663

280 x 206 x 25



O/E numbers

V.A.G. 1H0819644A / 1H0819638A

Cross References

Fram CF5663 Mann CU2882
Micronair MP044 Purflux AH104
Tecocar E311 Fiaam PC8005

CK 5663-C

280 x 206 x 25



O/E numbers

V.A.G. 1H0091800 / 8L0091800

Cross References

Fram CFA8893 Mann CUK2882
Micronair MC544 Purflux AHC104
Tecocar..... Fiaam PCK8072

--- Ibiza III ---

08/99 -> 02/02

*

*

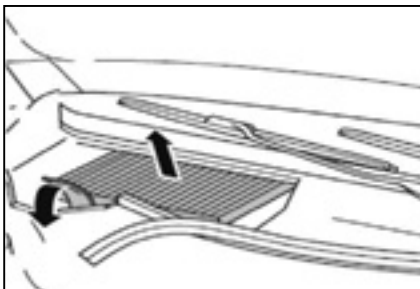

- Il filtro è posizionato nel vano motore al centro
- The filter is located in the engine compartment centrally
- Le filtre est situé dans le compartiment moteur au centre
- Der Filter befindet sich im Motorraum mitting
- El filtro se encuentra en el compartimiento del motor, en el centro

CK 8869-C

282 x 206 x 29



O/E numbers

V.A.G. 1J0819644 / 1J0819644A

Cross References



Fram CFA8869 Mann CUK2862
Micronair MC592 Purflux AHC178
Tecocar EC381 Fiaam PCK8045





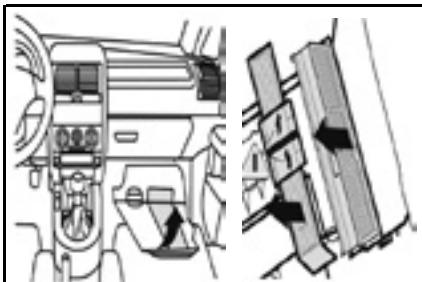

Anti-pollen

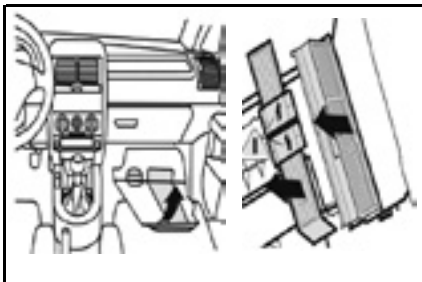

Activated carbon

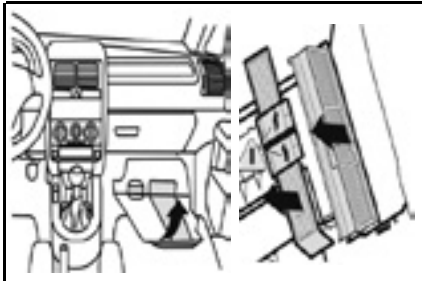

SEAT

<p>--- Ibiza IV ---</p> 	02/02 -> 12/09	*	*	<p>CK 9323</p> <p>251 x 215 x 32</p>  <p><u>O/E numbers</u> V.A.G. 6Q0820367</p> <p><u>Cross References</u> Fram CF9323 Mann CU2545 Micronair MP060 Purflux AH191 Tecocar E394 Fiaam PC8077</p>	<p>CK 9323-C</p> <p>251 x 215 x 32</p>  <p><u>O/E numbers</u> V.A.G. 6Q0819653 / 6Q0820367-S</p> <p><u>Cross References</u> Fram CFA9404 Mann CUK2545 Micronair MC560 Purflux AHC191 Tecocar EC394 Fiaam PCK8092</p>
	<p>I Il filtro è posizionato nell'abitacolo dietro il vano portaoggetti</p> <p>GB The filter is located in the passenger compartment behind the glove compartment</p> <p>F Le filtre est situé dans l'habitacle derrière la boîte à gants</p> <p>D Der filter befindet sich im Fahrgastraum hinter dem Handschuhfach</p> <p>E El filtro se encuentra en el habitáculo detrás de la guantera</p>				

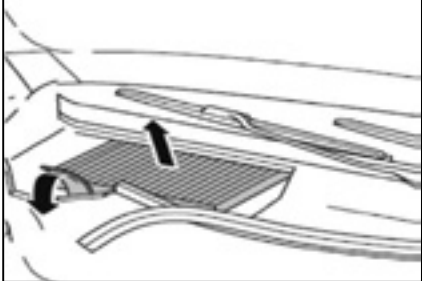
<p>--- Ibiza IV ---</p> 	05/08 -> 09/10	*	*	<p>CK 9323</p> <p>251 x 215 x 32</p>  <p><u>O/E numbers</u> V.A.G. 6Q0820367</p> <p><u>Cross References</u> Fram CF9323 Mann CU2545 Micronair MP060 Purflux AH191 Tecocar E394 Fiaam PC8077</p>	<p>CK 9323-C</p> <p>251 x 215 x 32</p>  <p><u>O/E numbers</u> V.A.G. 6Q0819653 / 6Q0820367-S</p> <p><u>Cross References</u> Fram CFA9404 Mann CUK2545 Micronair MC560 Purflux AHC191 Tecocar EC394 Fiaam PCK8092</p>
	<p>I Il filtro è posizionato nell'abitacolo dietro il vano portaoggetti</p> <p>GB The filter is located in the passenger compartment behind the glove compartment</p> <p>F Le filtre est situé dans l'habitacle derrière la boîte à gants</p> <p>D Der filter befindet sich im Fahrgastraum hinter dem Handschuhfach</p> <p>E El filtro se encuentra en el habitáculo detrás de la guantera</p>				

<p>--- Ibiza V ---</p> 	10/10 ->	*	*	<p>CK 26010</p> <p>252,5 x 223 x 36</p>  <p><u>O/E numbers</u> V.A.G. 6R0820367</p> <p><u>Cross References</u> Fram CF9323 Mann CU26010 Micronair MP400 Purflux AH191 Tecocar E394 Fiaam</p>	<p>CK 26010-C</p> <p>252,5 x 223 x 36</p>  <p><u>O/E numbers</u> V.A.G. 6R0819653</p> <p><u>Cross References</u> Fram CFA9404 Mann CUK26010 Micronair MC900 Purflux AHC191 Tecocar EC394 Fiaam PCK8092</p>
	<p>I Il filtro è posizionato nell'abitacolo dietro il vano portaoggetti</p> <p>GB The filter is located in the passenger compartment behind the glove compartment</p> <p>F Le filtre est situé dans l'habitacle derrière la boîte à gants</p> <p>D Der Filter befindet sich im Fahrgastraum hinter dem Handschuhfach</p> <p>E El filtro se encuentra en el habitáculo detrás de la guantera</p>				

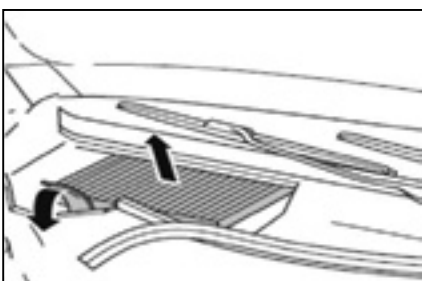
<p>--- Inca ---</p> 	11/95 -> 02/04	*	*	<p>CK 5663</p> <p>280 x 206 x 25</p>  <p><u>O/E numbers</u> V.A.G. 1H0819644A / 1H0819638A</p> <p><u>Cross References</u> Fram CF5663 Mann CU2882 Micronair MP044 Purflux AH104 Tecocar E311 Fiaam PC8005</p>	<p>CK 5663-C</p> <p>280 x 206 x 25</p>  <p><u>O/E numbers</u> V.A.G. 1H0091800 / 8L0091800</p> <p><u>Cross References</u> Fram CFA8893 Mann CUK2882 Micronair MC544 Purflux AHC104 Tecocar..... Fiaam PCK8072</p>
	<p>I Il filtro è posizionato nel vano motore al centro</p> <p>GB The filter is located in the engine compartment centrally</p> <p>F Le filtre est situé dans le compartiment moteur au centre</p> <p>D Der Filter befindet sich im Motorraum mitting</p> <p>E El filtro se encuentra en el compartimiento del motor, en el centro</p>				

<p>--- Leon I ---</p> 	09/99 -> 10/05	*	*	<p>---</p>	<p>CK 8869-C</p> <p>282 x 206 x 29</p>  <p><u>O/E numbers</u> V.A.G. 1J0819644 / 1J0819644A</p> <p><u>Cross References</u> Fram CFA8869 Mann CUK2862 Micronair MC592 Purflux AHC178 Tecocar EC381 Fiaam PCK8045</p>
	<p>I Il filtro è posizionato nel vano motore al centro</p> <p>GB The filter is located in the engine compartment centrally</p> <p>F Le filtre est situé dans le compartiment moteur au centre</p> <p>D Der Filter befindet sich im Motorraum mitting</p> <p>E El filtro se encuentra en el compartimiento del motor, en el centro</p>				



Anti-pollen

Activated carbon

SEAT

--- Leon II ---

09/05 ->

*

*

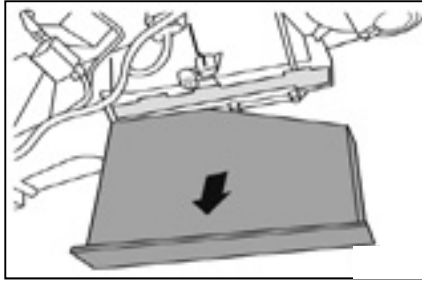

- Il filtro è posizionato nell'abitacolo sotto il vano portaoggetti
- The filter is located in the passenger compartment under the glove compartment
- Le filtre est situé dans l'habitacle en dessous de la boîte à gants
- Der filter befindet sich im Fahrgastraum unter dem Handsuhfach
- El filtro se encuentra en el habitáculo, bajo la guanterain de pasajerruimte

CK 9922

286/280 x 214 x 34/57



O/E numbers

V.A.G. 1K0819644 / 1K0819644A

Cross References

Fram CF9922 Mann CU2939
 Micronair MP113 Purflux AH202
 Tecocar E409 Fiaam PC8155

CK 9922-C

286/280 x 214 x 34/57



O/E numbers

V.A.G. 1K1819653 / 1K1819653A

Cross References

Fram CFA9921 Mann CUK2939
 Micronair MC613 Purflux AHC202
 Tecocar EC409 Fiaam PCK8155

--- Leon III ---

11/12 ->

*

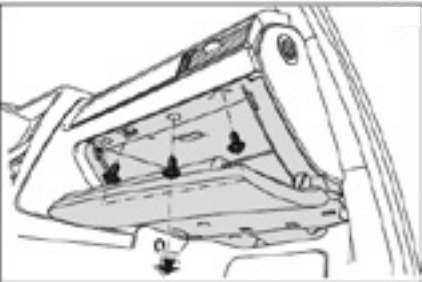

- Il filtro è posizionato nell'abitacolo sotto il vano portaoggetti
- The filter is located in the passenger compartment under the glove compartment
- Le filtre est situé dans l'habitacle en dessous de la boîte à gants
- Der filter befindet sich im Fahrgastraum unter dem Handsuhfach
- El filtro se encuentra en el habitáculo, bajo la guanterain de pasajerruimte

CK 26009

253 x 234 x 30



O/E numbers

V.A.G. 5Q0819644 / 5Q0819644A

Cross References

Fram Mann CU26009
 Micronair MP437 Purflux
 Tecocar Fiaam

CK 26009-C

253 x 234 x 30



O/E numbers

V.A.G. 5Q0819653

Cross References

Fram CFA11643 Mann CUK26009
 Micronair MC937 Purflux AHC392
 Tecocar EC683 Fiaam PCK8361

--- Mii ---

12/11 ->

*

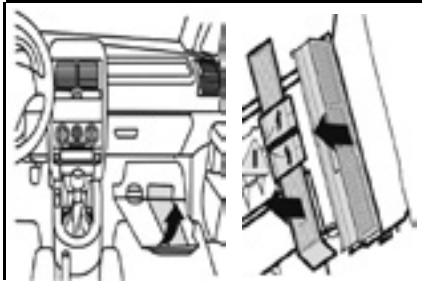

- Il filtro è posizionato nell'abitacolo dietro il vano portaoggetti
- The filter is located in the passenger compartment behind the glove compartment
- Le filtre est situé dans l'habitacle derrière la boîte à gants
- Der filter befindet sich im Fahrgastraum hinter dem Handsuhfach
- El filtro se encuentra en el habitáculo detrás de la guantera

CK 26006

254 x 182 x 35



O/E numbers

V.A.G. 1S0820367

Cross References

Fram CF11464 Mann CU26006
 Micronair MP421 Purflux AH370
 Tecocar E664 Fiaam PC8339

--- Toledo I ---

05/91 -> 03/99

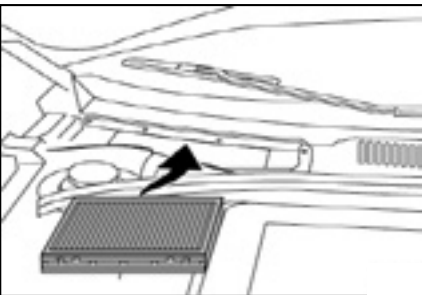

- Il filtro è posizionato nel vano motore sul lato passeggero
- The filter is located in the engine compartment on the passenger's side
- Le filtre est situé dans le compartiment moteur du côté passager
- Der filter befindet sich Motorraum auf der Beifahrerseite
- El filtro se encuentra en el compartimiento del motor, del lado del acompañante

CK 5990

191/181 x 180/170 x 39



O/E numbers

V.A.G. 191091700 / 191819638

Cross References

Fram CF5990 Mann CU2038
 Micronair Purflux AH135
 Tecocar E334 Fiaam PC8034

--- Toledo II ---

04/99 -> 05/06

*

*

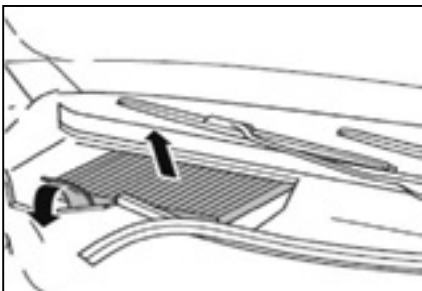

- Il filtro è posizionato nel vano motore al centro
- The filter is located in the engine compartment centrally
- Le filtre est situé dans le compartiment moteur au centre
- Der Filter befindet sich im Motorraum mitting
- El filtro se encuentra en el compartimiento del motor, en el centro

CK 8869-C

282 x 206 x 29



O/E numbers

V.A.G. 1J0819644 / 1J0819644A

Cross References

Fram CFA8869 Mann CUK2862
 Micronair MC592 Purflux AHC178
 Tecocar EC381 Fiaam PCK8045







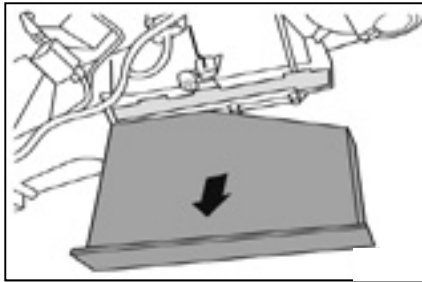

Anti-pollen

Activated carbon

SEAT

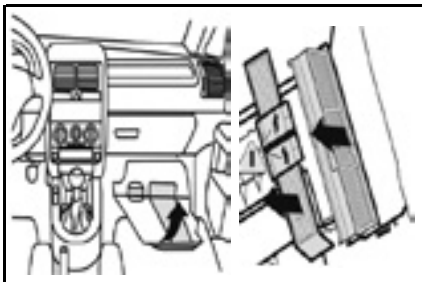
<p>--- Toledo III ---</p>  <p> <i>I</i> Il filtro è posizionato nell'abitacolo sotto il vano portaoggetti <i>GB</i> The filter is located in the passenger compartment under the glove compartment <i>F</i> Le filtre est situé dans l'habitacle en dessous de la boîte à gants <i>D</i> Der filter befindet sich im Fahrgastraum unter dem Handshuhfach <i>E</i> El filtro se encuentra en el habitáculo, bajo la guantera de pasajerruimte </p>	<p>05/03 -></p>	<p>*</p>	<p>*</p>	<p>CK 9922 286/280 x 214 x 34/57</p>  <p><u>O/E numbers</u> V.A.G. 1K0819644 / 1K0819644A</p> <p><u>Cross References</u> Fram CF9922 Mann CU2939 Micronair MP113 Purflux AH202 Tecocar E409 Fiaam PC8155</p>	<p>CK 9922-C 286/280 x 214 x 34/57</p>  <p><u>O/E numbers</u> V.A.G. 1K1819653 / 1K1819653A</p> <p><u>Cross References</u> Fram CFA9921 Mann CUK2939 Micronair MC613 Purflux AHC202 Tecocar EC409 Fiaam PCK8155</p>
---	--------------------	----------	----------	--	--

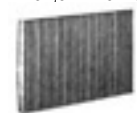
<p>--- Toledo IV ---</p>  <p> <i>I</i> Il filtro è posizionato nell'abitacolo dietro il vano portaoggetti <i>GB</i> The filter is located in the passenger compartment behind the glove compartment <i>F</i> Le filtre est situé dans l'habitacle derrière la boîte à gants <i>D</i> Der filter befindet sich im Fahrgastraum hinter dem Handshuhfach <i>E</i> El filtro se encuentra en el habitáculo detrás de la guantera </p>	<p>10/12 -></p>	<p>*</p>	<p>*</p>	<p>CK 26010 252,5 x 223 x 36</p>  <p><u>O/E numbers</u> V.A.G. 6R0820367</p> <p><u>Cross References</u> Fram CF9323 Mann CU26010 Micronair MP400 Purflux AH191 Tecocar E394 Fiaam</p>	<p>CK 26010-C 252,5 x 223 x 36</p>  <p><u>O/E numbers</u> V.A.G. 6R0819653</p> <p><u>Cross References</u> Fram CFA9404 Mann CUK26010 Micronair MC900 Purflux AHC191 Tecocar EC394 Fiaam PCK8092</p>
---	--------------------	----------	----------	---	--

--	--	--

--	--	--



--	--	--





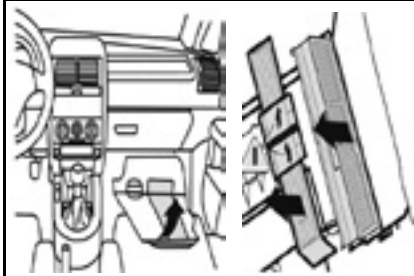

Anti-pollen

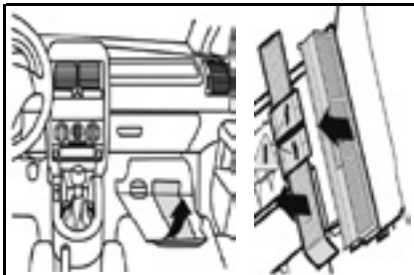

Activated carbon

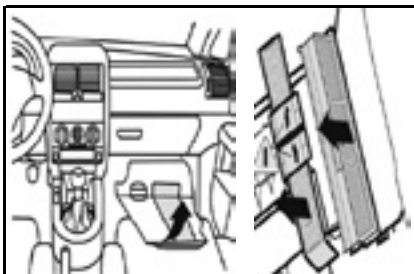

SKODA

<p>--- Citigo ---</p>  <p> I Il filtro è posizionato nell'abitacolo dietro il vano portaoggetti GB The filter is located in the passenger compartment behind the glove compartment F Le filtre est situé dans l'habitacle derrière la boîte à gants D Der filter befindet sich im Fahrgastraum hinter dem Handschuhfach E El filtro se encuentra en el habitáculo detrás de la guantera </p>	<p>12/11 -></p>	<p>*</p>	<p>CK 26006 254 x 182 x 35</p>  <p><u>O/E numbers</u> Skoda</p> <p><u>Cross References</u> Fram CF11464 Mann CU26006 Micronair MP421 Purflux AH370 Tecocar E664 Fiaam PC8339</p>	<p>---</p>
--	--------------------	----------	---	------------

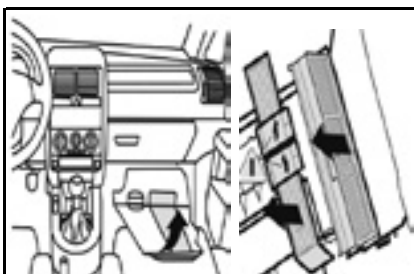
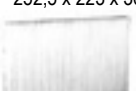
<p>--- Fabia I ---</p>  <p> I Il filtro è posizionato nell'abitacolo sotto il vano portaoggetti GB The filter is located in the passenger compartment under the glove compartment F Le filtre est situé dans l'habitacle en dessous de la boîte à gants D Der filter befindet sich im Fahrgastraum unter dem Handschuhfach E El filtro se encuentra en el habitáculo, bajo la guantera de pasajeriunte </p>	<p>09/99 -> 04/08</p>	<p>*</p>	<p>CK 9323 251 x 215 x 32</p>  <p><u>O/E numbers</u> V.A.G. 6Q0820367</p> <p><u>Cross References</u> Fram CF9323 Mann CU2545 Micronair MP060 Purflux AH191 Tecocar E394 Fiaam PC8077</p>	<p>CK 9323-C 251 x 215 x 32</p>  <p><u>O/E numbers</u> V.A.G. 6Q0819653 / 6Q0820367-S</p> <p><u>Cross References</u> Fram CFA9404 Mann CUK2545 Micronair MC560 Purflux AHC191 Tecocar EC394 Fiaam PCK8092</p>
---	--------------------------	----------	---	---

<p>--- Fabia II ---</p>  <p> I Il filtro è posizionato nell'abitacolo sotto il vano portaoggetti GB The filter is located in the passenger compartment under the glove compartment F Le filtre est situé dans l'habitacle en dessous de la boîte à gants D Der filter befindet sich im Fahrgastraum unter dem Handschuhfach E El filtro se encuentra en el habitáculo, bajo la guantera de pasajeriunte </p>	<p>02/07 -> 07/10</p>	<p>*</p>	<p>CK 9323 251 x 215 x 32</p>  <p><u>O/E numbers</u> V.A.G. 6Q0820367</p> <p><u>Cross References</u> Fram CF9323 Mann CU2545 Micronair MP060 Purflux AH191 Tecocar E394 Fiaam PC8077</p>	<p>CK 9323-C 251 x 215 x 32</p>  <p><u>O/E numbers</u> V.A.G. 6Q0819653 / 6Q0820367-S</p> <p><u>Cross References</u> Fram CFA9404 Mann CUK2545 Micronair MC560 Purflux AHC191 Tecocar EC394 Fiaam PCK8092</p>
--	--------------------------	----------	---	---

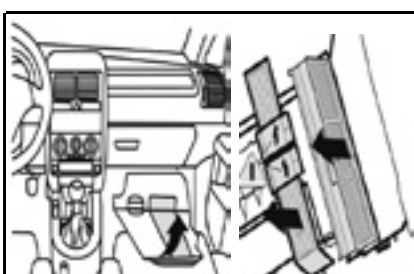
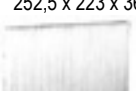
<p>--- Fabia II ---</p>  <p> I Il filtro è posizionato nell'abitacolo dietro il vano portaoggetti GB The filter is located in the passenger compartment behind the glove compartment F Le filtre est situé dans l'habitacle derrière la boîte à gants D Der filter befindet sich im Fahrgastraum hinter dem Handschuhfach E El filtro se encuentra en el habitáculo detrás de la guantera </p>	<p>08/10 -></p>	<p>*</p>	<p>CK 26010 252,5 x 223 x 36</p>  <p><u>O/E numbers</u> V.A.G. 6R0820367</p> <p><u>Cross References</u> Fram CF9323 Mann CU26010 Micronair MP400 Purflux AH191 Tecocar E394 Fiaam</p>	<p>CK 26010-C 252,5 x 223 x 36</p>  <p><u>O/E numbers</u> V.A.G. 6R0819653</p> <p><u>Cross References</u> Fram CFA9404 Mann CUK26010 Micronair MC900 Purflux AHC191 Tecocar EC394 Fiaam PCK8092</p>
--	--------------------	----------	--	---









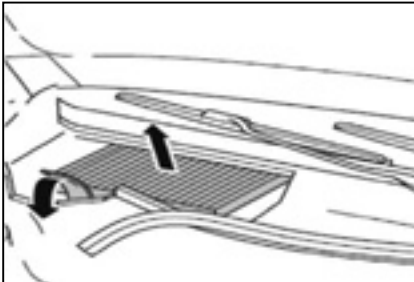

<p>--- Fabia III ---</p>  <p> I Il filtro è posizionato nell'abitacolo dietro il vano portaoggetti GB The filter is located in the passenger compartment behind the glove compartment F Le filtre est situé dans l'habitacle derrière la boîte à gants D Der filter befindet sich im Fahrgastraum hinter dem Handschuhfach E El filtro se encuentra en el habitáculo detrás de la guantera </p>	<p>09/14 -></p>	<p>*</p>	<p>CK 26010 252,5 x 223 x 36</p>  <p><u>O/E numbers</u> V.A.G. 6R0820367</p> <p><u>Cross References</u> Fram CF9323 Mann CU26010 Micronair MP400 Purflux AH191 Tecocar E394 Fiaam</p>	<p>CK 26010-C 252,5 x 223 x 36</p>  <p><u>O/E numbers</u> V.A.G. 6R0819653</p> <p><u>Cross References</u> Fram CFA9404 Mann CUK26010 Micronair MC900 Purflux AHC191 Tecocar EC394 Fiaam PCK8092</p>
---	--------------------	----------	--	---

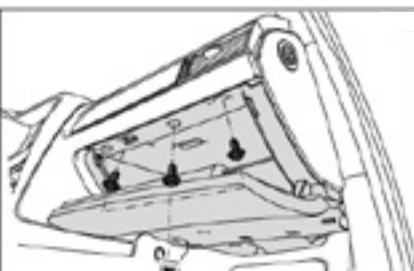

Anti-pollen

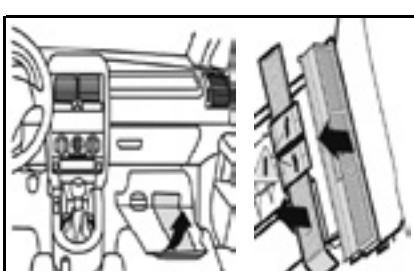
Activated carbon

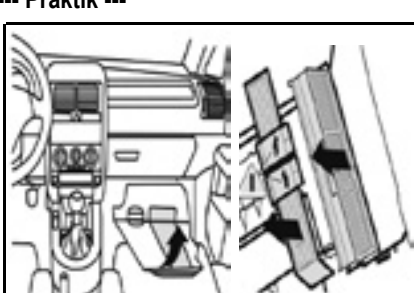
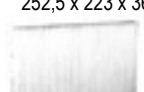
SKODA

<p>--- Octavia I ---</p> 	<p>09/96 -> 09/04</p> <p>* *</p> <p>I Il filtro è posizionato nel vano motore al centro GB The filter is located in the engine compartment centrally F Le filtre est situé dans le compartiment moteur au centre D Der Filter befindet sich im Motorraum mittig E El filtro se encuentra en el compartimiento del motor, en el centro</p>	<p>CK 5663 280 x 206 x 25</p>  <p><u>O/E numbers</u> V.A.G. 1H0819644A / 1H0819638A</p> <p><u>Cross References</u> Fram CF5663 Mann CU2882 Micronair MP044 Purflux AH104 Tecocar E311 Fiaam PC8005</p>	<p>CK 5663-C 280 x 206 x 25</p>  <p><u>O/E numbers</u> V.A.G. 1H0091800 / 8L0091800</p> <p><u>Cross References</u> Fram CFA8893 Mann CUK2882 Micronair MC544 Purflux AHC104 Tecocar..... Fiaam PCK8072</p>
<p>--- Octavia II ---</p> 	<p>06/04 -></p> <p>* *</p> <p>I Il filtro è posizionato nell'abitacolo sotto il vano portaoggetti GB The filter is located in the passenger compartment under the glove compartment F Le filtre est situé dans l'habitacle en dessous de la boîte à gants D Der filter befindet sich im Fahrgastraum unter dem Handshuhfach E El filtro se encuentra en el habitáculo, bajo la guanterain de pasajerruimte</p>	<p>CK 9922 286/280 x 214 x 34/57</p>  <p><u>O/E numbers</u> V.A.G. 1K0819644 / 1K0819644A</p> <p><u>Cross References</u> Fram CF9922 Mann CU2939 Micronair MP113 Purflux AH202 Tecocar E409 Fiaam PC8155</p>	<p>CK 9922-C 286/280 x 214 x 34/57</p>  <p><u>O/E numbers</u> V.A.G. 1K1819653 / 1K1819653A</p> <p><u>Cross References</u> Fram CFA9921 Mann CUK2939 Micronair MC613 Purflux AHC202 Tecocar EC409 Fiaam PCK8155</p>
<p>--- Octavia III ---</p> 	<p>01/13 -></p> <p>* </p> <p>I Il filtro è posizionato nell'abitacolo sotto il vano portaoggetti GB The filter is located in the passenger compartment under the glove compartment F Le filtre est situé dans l'habitacle en dessous de la boîte à gants D Der filter befindet sich im Fahrgastraum unter dem Handshuhfach E El filtro se encuentra en el habitáculo, bajo la guanterain de pasajerruimte</p>	<p>CK 26009 253 x 234 x 30</p>  <p><u>O/E numbers</u> V.A.G. 5Q0819644 / 5Q0819644A</p> <p><u>Cross References</u> Fram Mann CU26009 Micronair MP437 Purflux Tecocar Fiaam</p>	<p>CK 26009-C 253 x 234 x 30</p>  <p><u>O/E numbers</u> V.A.G. 5Q0819653</p> <p><u>Cross References</u> Fram CFA11643 Mann CUK26009 Micronair MC937 Purflux AHC392 Tecocar EC683 Fiaam PCK8361</p>
<p>--- Praktik ---</p> 	<p>06/07 -> 07/10</p> <p>* *</p> <p>I Il filtro è posizionato nell'abitacolo sotto il vano portaoggetti GB The filter is located in the passenger compartment under the glove compartment F Le filtre est situé dans l'habitacle en dessous de la boîte à gants D Der filter befindet sich im Fahrgastraum unter dem Handshuhfach E El filtro se encuentra en el habitáculo, bajo la guanterain de pasajerruimte</p>	<p>CK 9323 251 x 215 x 32</p>  <p><u>O/E numbers</u> V.A.G. 6Q0820367</p> <p><u>Cross References</u> Fram CF9323 Mann CU2545 Micronair MP060 Purflux AH191 Tecocar E394 Fiaam PC8077</p>	<p>CK 9323-C 251 x 215 x 32</p>  <p><u>O/E numbers</u> V.A.G. 6Q0819653 / 6Q0820367-S</p> <p><u>Cross References</u> Fram CFA9404 Mann CUK2545 Micronair MC560 Purflux AHC191 Tecocar EC394 Fiaam PCK8092</p>
<p>--- Praktik ---</p> 	<p>08/10 -></p> <p>* *</p> <p>I Il filtro è posizionato nell'abitacolo dietro il vano portaoggetti GB The filter is located in the passenger compartment behind the glove compartment F Le filtre est situé dans l'habitacle derrière la boîte à gants D Der filter befindet sich im Fahrgastraum hinter dem Handshuhfach E El filtro se encuentra en el habitáculo detrás de la guantera</p>	<p>CK 26010 252,5 x 223 x 36</p>  <p><u>O/E numbers</u> V.A.G. 6R0820367</p> <p><u>Cross References</u> Fram CF9323 Mann CU26010 Micronair MP400 Purflux AH191 Tecocar E394 Fiaam</p>	<p>CK 26010-C 252,5 x 223 x 36</p>  <p><u>O/E numbers</u> V.A.G. 6R0819653</p> <p><u>Cross References</u> Fram CFA9404 Mann CUK26010 Micronair MC900 Purflux AHC191 Tecocar EC394 Fiaam PCK8092</p>



Anti-pollen

Activated carbon

SKODA

--- Rapid (NA2) ---

01/11 ->

*

*

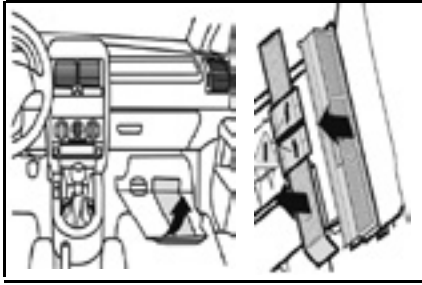

- Il filtro è posizionato nell'abitacolo sotto il vano portaoggetti
- The filter is located in the passenger compartment under the glove compartment
- Le filtre est situé dans l'habitacle en dessous de la boîte à gants
- Der filter befindet sich im Fahrgastraum unter dem Handsuhfach
- El filtro se encuentra en el habitáculo, bajo la guanterain de passajeriunte

CK 9323

251 x 215 x 32



O/E numbers

V.A.G. 6Q0820367

Cross References

Fram CF9323 Mann CU2545
 Micronair MP060 Purflux AH191
 Tecocar E394 Fiaam PC8077

CK 9323-C

251 x 215 x 32



O/E numbers

V.A.G. 6Q0819653 / 6Q0820367-S

Cross References

Fram CFA9404 Mann CUK2545
 Micronair MC560 Purflux AHC191
 Tecocar EC394 Fiaam PCK8092

--- Rapid (NH3, NH1) ---

10/12 ->

*

*

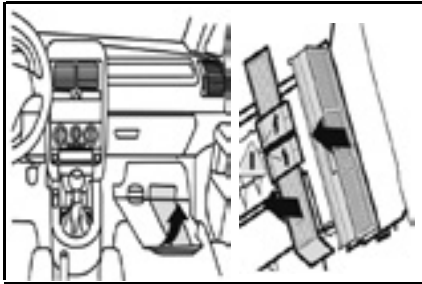

- Il filtro è posizionato nell'abitacolo dietro il vano portaoggetti
- The filter is located in the passenger compartment behind the glove compartment
- Le filtre est situé dans l'habitacle derrière la boîte à gants
- Der filter befindet sich im Fahrgastraum hinter dem Handsuhfach
- El filtro se encuentra en el habitáculo detrás de la guantera

CK 26010

252,5 x 223 x 36

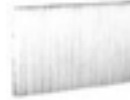

O/E numbers

V.A.G. 6R0820367

Cross References

Fram CF9323 Mann CU26010
 Micronair MP400 Purflux AH191
 Tecocar E394 Fiaam

CK 26010-C

252,5 x 223 x 36



O/E numbers

V.A.G. 6R0819653

Cross References

Fram CFA9404 Mann CUK26010
 Micronair MC900 Purflux AHC191
 Tecocar EC394 Fiaam PCK8092

--- Roomster ---

06/06 -> 07/10

*

*

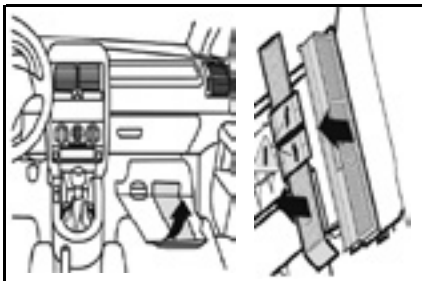

- Il filtro è posizionato nell'abitacolo sotto il vano portaoggetti
- The filter is located in the passenger compartment under the glove compartment
- Le filtre est situé dans l'habitacle en dessous de la boîte à gants
- Der filter befindet sich im Fahrgastraum unter dem Handsuhfach
- El filtro se encuentra en el habitáculo, bajo la guanterain de passajeriunte

CK 9323

251 x 215 x 32



O/E numbers

V.A.G. 6Q0820367

Cross References

Fram CF9323 Mann CU2545
 Micronair MP060 Purflux AH191
 Tecocar E394 Fiaam PC8077

CK 9323-C

251 x 215 x 32



O/E numbers

V.A.G. 6Q0819653 / 6Q0820367-S

Cross References

Fram CFA9404 Mann CUK2545
 Micronair MC560 Purflux AHC191
 Tecocar EC394 Fiaam PCK8092

--- Roomster ---

08/10 ->

*

*

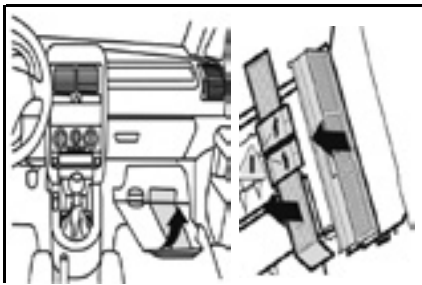

- Il filtro è posizionato nell'abitacolo dietro il vano portaoggetti
- The filter is located in the passenger compartment behind the glove compartment
- Le filtre est situé dans l'habitacle derrière la boîte à gants
- Der filter befindet sich im Fahrgastraum hinter dem Handsuhfach
- El filtro se encuentra en el habitáculo detrás de la guantera

CK 26010

252,5 x 223 x 36



O/E numbers

V.A.G. 6R0820367

Cross References

Fram CF9323 Mann CU26010
 Micronair MP400 Purflux AH191
 Tecocar E394 Fiaam

CK 26010-C

252,5 x 223 x 36



O/E numbers

V.A.G. 6R0819653

Cross References

Fram CFA9404 Mann CUK26010
 Micronair MC900 Purflux AHC191
 Tecocar EC394 Fiaam PCK8092

--- Superb ---

09/01 -> 09/08

*

*

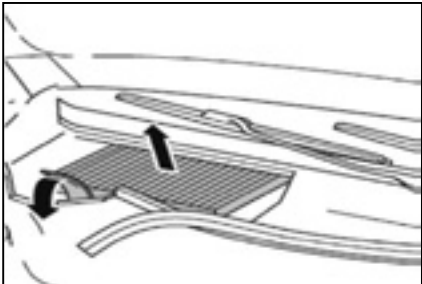

- Il filtro è posizionato nel vano motore al centro
- The filter is located in the engine compartment centrally
- Le filtre est situé dans le compartiment moteur au centre
- Der Filter befindet sich im Motorraum mitting
- El filtro se encuentra en el compartimiento del motor, en el centro

CK 5663

280 x 206 x 25



O/E numbers

V.A.G. 1H0819644A / 1H0819638A

Cross References

Fram CF5663 Mann CU2882
 Micronair MP044 Purflux AH104
 Tecocar E311 Fiaam PC8005

CK 5663-C

280 x 206 x 25



O/E numbers

V.A.G. 1H0091800 / 8L0091800

Cross References

Fram CFA8893 Mann CUK2882
 Micronair MC544 Purflux AHC104
 Tecocar..... Fiaam PCK8072



Anno di fabbricazione / Year of construction
 Anné de fabrication / Baujahr / Año de fabricaciór



Con climatizzatore / With air-conditioning / Avec climatisation
 Mit Klimaanlage / Con instalación de aire acondicionado



Senza climatizzatore / Without air-conditioning / Sans climatisation
 Ohne Klimaanlage / Sin instalación de aire acondicionado



Anti-pollen

Activated carbon

SKODA

--- Superb II ---

07/08 ->

*

*

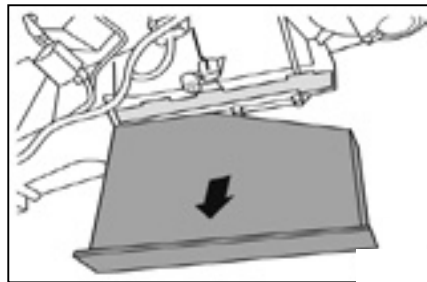

- Il filtro è posizionato nell'abitacolo sotto il vano portaoggetti
- The filter is located in the passenger compartment under the glove compartment
- Le filtre est situé dans l'habitacle en dessous de la boîte à gants
- Der filter befindet sich im Fahrgastraum unter dem Handshuhfach
- El filtro se encuentra en el habitáculo, bajo la guantera de pasajerruimte

CK 9922

286/280 x 214 x 34/57



O/E numbers

V.A.G. 1K0819644 / 1K0819644A

Cross References

Fram CF9922	Mann CU2939
Micronair MP113	Purflux AH202
Tecocar E409	Fiaam PC8155

CK 9922-C

286/280 x 214 x 34/57



O/E numbers

V.A.G. 1K1819653 / 1K1819653A

Cross References

Fram CFA9921	Mann CUK2939
Micronair MC613	Purflux AHC202
Tecocar EC409	Fiaam PCK8155

--- Superb III ---

05/15 ->

*

*

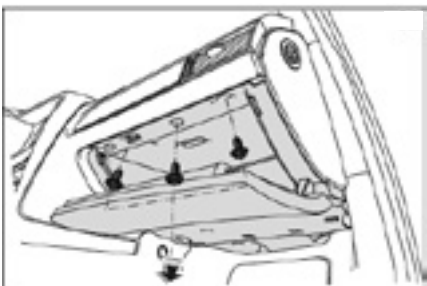

- Il filtro è posizionato nell'abitacolo sotto il vano portaoggetti
- The filter is located in the passenger compartment under the glove compartment
- Le filtre est situé dans l'habitacle en dessous de la boîte à gants
- Der filter befindet sich im Fahrgastraum unter dem Handshuhfach
- El filtro se encuentra en el habitáculo, bajo la guantera de pasajerruimte

CK 26009

253 x 234 x 30



O/E numbers

V.A.G. 5Q0819644 / 5Q0819644A

Cross References

Fram	Mann CU26009
Micronair MP437	Purflux
Tecocar	Fiaam

CK 26009-C

253 x 234 x 30



O/E numbers

V.A.G. 5Q0819653

Cross References

Fram CFA11643	Mann CUK26009
Micronair MC937	Purflux AHC392
Tecocar EC683	Fiaam PCK8361

--- Yeti ---

08/09 ->

*

*

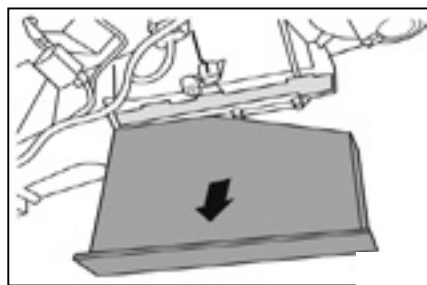

- Il filtro è posizionato nell'abitacolo sotto il vano portaoggetti
- The filter is located in the passenger compartment under the glove compartment
- Le filtre est situé dans l'habitacle en dessous de la boîte à gants
- Der filter befindet sich im Fahrgastraum unter dem Handshuhfach
- El filtro se encuentra en el habitáculo, bajo la guantera de pasajerruimte

CK 9922

286/280 x 214 x 34/57



O/E numbers

V.A.G. 1K0819644 / 1K0819644A

Cross References

Fram CF9922	Mann CU2939
Micronair MP113	Purflux AH202
Tecocar E409	Fiaam PC8155

CK 9922-C

286/280 x 214 x 34/57



O/E numbers

V.A.G. 1K1819653 / 1K1819653A

Cross References

Fram CFA9921	Mann CUK2939
Micronair MC613	Purflux AHC202
Tecocar EC409	Fiaam PCK8155



Anti-pollen

Activated carbon

SMART (DAIMLER AG)

--- City-Coupe/Cabrio/Fortwo (450) ---

08/97 -> 03/07

*

*

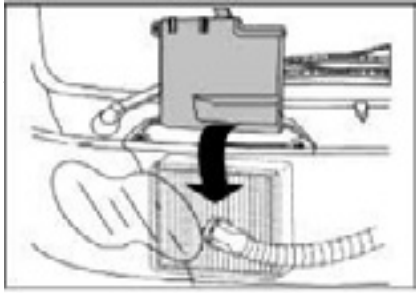

- I** Il filtro è posizionato nel vano motore al centro
- GB** The filter is located in the engine compartment centrally
- F** Le filtre est situé dans le compartiment moteur au centre
- D** Der Filter befindet sich im Motorraum mittig
- E** El filtro se encuentra en el compartimiento del motor, en el centro

CK 9445-C

204 x 198 x 40



O/E numbers

Smart 0001110V003 / 0001110V004

Cross References

Fram CFA9445 Mann CUK2032
Micronair MC590 Purflux AHC188
Tecocar EC391 Fiaam PCK8095

--- Forfour (454) ---

09/14 ->

*

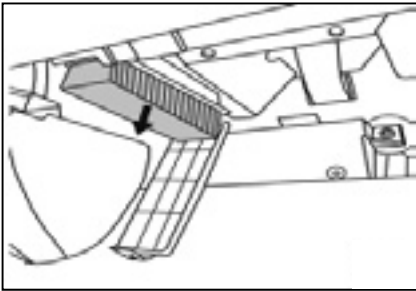

- I** Il filtro è posizionato nell'abitacolo dietro il vano portaoggetti
- GB** The filter is located in the passenger compartment behind the glove compartment
- F** Le filtre est situé dans l'habitacle derrière la boîte à gants
- D** Der filter befindet sich im Fahrgastraum hinter dem Handschuhfach
- E** El filtro se encuentra en el habitáculo detrás de la guantera

CK 1830-C

202 x 178 x 40



O/E numbers

Smart

Cross References

Fram CFA10582 Mann CUK1830
Micronair MC670 Purflux AHC278
Tecocar EC494 Fiaam PCK8229

--- Fortwo Coupé / Cabrio II (451) ---

03/07 ->

*

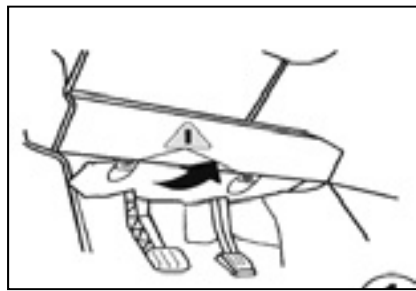

- I** Il filtro è posizionato nell'abitacolo sul lato conducente
- GB** The filter is located in the passenger compartment on the driver's side
- F** Le filtre est situé dans l'habitacle du côté conducteur
- D** Der Filter befindet sich im Fahrgastraum auf der Fahrerseite
- E** El Filtro se encuentra en el habitáculo, del lado del conductor

CK 2132-C

216 x 214 x 25



O/E numbers

Smart

Cross References

Fram CFA10612 Mann CUK2132
Micronair MC816 Purflux
Tecocar EC491 Fiaam

--- Fortwo, Forfour (453) ---

09/14 ->

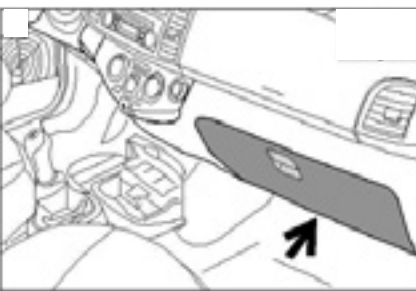

- I** Il filtro è posizionato nell'abitacolo sotto il vano portaoggetti
- GB** The filter is located in the passenger compartment under the glove compartment
- F** Le filtre est situé dans l'habitacle en dessous de la boîte à gants
- D** Der filter befindet sich im Fahrgastraum unter dem Handschuhfach
- E** El filtro se encuentra en el habitáculo, bajo la guantera en el compartimiento de pasajeros

CK 22021-C

214 x 214 x 25



O/E numbers

Smart

Cross References

Fram Mann CUK22021
Micronair Purflux
Tecocar Fiaam

--- Roadster / Roadster Coupe (452) ---

04/03 -> 12/05

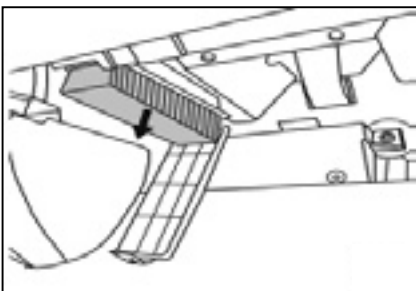

- I** Il filtro è posizionato nell'abitacolo dietro il vano portaoggetti
- GB** The filter is located in the passenger compartment behind the glove compartment
- F** Le filtre est situé dans l'habitacle derrière la boîte à gants
- D** Der filter befindet sich im Fahrgastraum hinter dem Handschuhfach
- E** El filtro se encuentra en el habitáculo detrás de la guantera

CK 1830-C

202 x 178 x 40



O/E numbers

Smart

Cross References

Fram CFA10582 Mann CUK1830
Micronair MC670 Purflux AHC278
Tecocar EC494 Fiaam PCK8229



Anno di fabbricazione / Year of construction

Anné de fabrication / Baujahr / Año de fabricación



Con climatizzatore / With air-conditioning / Avec climatisation

Mit Klimaanlage / Con instalación de aire acondicionado



Senza climatizzatore / Without air-conditioning / Sans climatisation



Ohne Klimaanlage / Sin instalación de aire acondicionado





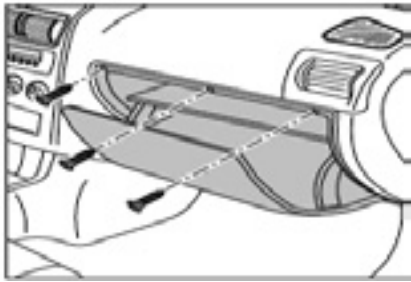

Anti-pollen



Activated carbon



SUBARU

<p>--- BRZ ---</p> 	<p>06/12 -> * </p>	<p>CK 1827 185 x 180 x 30</p>  <p><u>O/E numbers</u> Subaru 72880AJ010</p> <p><u>Cross References</u> Fram CF10202 Mann CU1827 Micronair MP252/MP198 Purflux AH249 Tecnocar E457 Fiaam PC8176</p>
<p>Il filtro è posizionato nell'abitacolo dietro il vano portaoggetti</p> <p>The filter is located in the passenger compartment behind the glove compartment</p> <p>Le filtre est situé dans l'habitacle derrière la boîte à gants</p> <p>Der filter befindet sich im Fahrgastraum hinter dem Handshuhfach</p> <p>El filtro se encuentra en el habitáculo detrás de la guantera</p>		

<p>--- Forester (SF, SG) ---</p> 	<p>09/97 -> * </p>	<p>CK 224 220 x 200 x 30/45</p>  <p><u>O/E numbers</u> Subaru G3010SA100</p> <p><u>Cross References</u> Fram..... Mann CU22003 Micronair MP224 Purflux..... Tecnocar..... Fiaam.....</p>
<p>Il filtro è posizionato nell'abitacolo dietro il vano portaoggetti</p> <p>The filter is located in the passenger compartment behind the glove compartment</p> <p>Le filtre est situé dans l'habitacle derrière la boîte à gants</p> <p>Der filter befindet sich im Fahrgastraum hinter dem Handshuhfach</p> <p>El filtro se encuentra en el habitáculo detrás de la guantera</p>		

<p>--- Forester (SH) ---</p> 	<p>04/08 -> * </p>	<p>CK 22004 219 x 235 x 58</p>  <p><u>O/E numbers</u> Subaru 72880FG000-72880FG0009P</p> <p><u>Cross References</u> Fram CF10930 Mann CU22004 Micronair Purflux AH401 Tecnocar E692 Fiaam PC8370</p>
<p>Il filtro è posizionato nell'abitacolo dietro il vano portaoggetti</p> <p>The filter is located in the passenger compartment behind the glove compartment</p> <p>Le filtre est situé dans l'habitacle derrière la boîte à gants</p> <p>Der filter befindet sich im Fahrgastraum hinter dem Handshuhfach</p> <p>El filtro se encuentra en el habitáculo detrás de la guantera</p>		

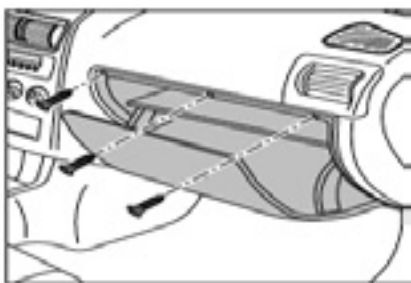
<p>--- Forester (SJ) ---</p> 	<p>03/13 -> * </p>	<p>CK 22004 219 x 235 x 58</p>  <p><u>O/E numbers</u> Subaru 72880FG000-72880FG0009P</p> <p><u>Cross References</u> Fram CF10930 Mann CU22004 Micronair Purflux AH401 Tecnocar E692 Fiaam PC8370</p>
<p>Il filtro è posizionato nell'abitacolo dietro il vano portaoggetti</p> <p>The filter is located in the passenger compartment behind the glove compartment</p> <p>Le filtre est situé dans l'habitacle derrière la boîte à gants</p> <p>Der filter befindet sich im Fahrgastraum hinter dem Handshuhfach</p> <p>El filtro se encuentra en el habitáculo detrás de la guantera</p>		

<p>--- Impreza II (GD/GG) ---</p> 	<p>12/00 -> 08/07 * </p>	<p>CK 22023 213 x 190 x 30</p>  <p><u>O/E numbers</u> Subaru 72880FE000 - G3010FE200</p> <p><u>Cross References</u> Fram CF11862 Mann CU2145 Micronair MP225 Purflux AH484 Tecnocar E726 Fiaam PC8420</p>
<p>Il filtro è posizionato nell'abitacolo dietro il vano portaoggetti</p> <p>The filter is located in the passenger compartment behind the glove compartment</p> <p>Le filtre est situé dans l'habitacle derrière la boîte à gants</p> <p>Der filter befindet sich im Fahrgastraum hinter dem Handshuhfach</p> <p>El filtro se encuentra en el habitáculo detrás de la guantera</p>		



Anti-pollen

Activated carbon

SUBARU

<p>--- Impreza II (G3) ---</p>	<p>09/07 -></p>	<p>*</p>	<p></p>	<p>CK 22004 219 x 235 x 58</p>  <p><u>O/E numbers</u> Subaru 72880FG000-72880FG0009P</p> <p><u>Cross References</u> Fram CF10930 Mann CU22004 Micronair Purflux AH401 Tecocar E692 Fiaam PC8370</p>	
--------------------------------	--------------------	----------	---------	---	--

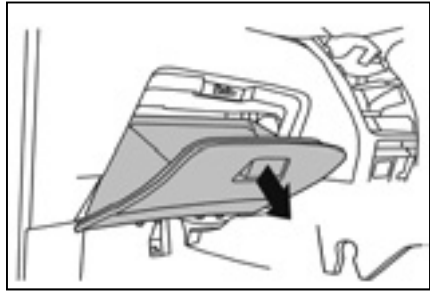

- I** Il filtro è posizionato nell'abitacolo dietro il vano portaoggetti
- GB** The filter is located in the passenger compartment behind the glove compartment
- F** Le filtre est situé dans l'habitacle derrière la boîte à gants
- D** Der filter befindet sich im Fahrgastraum hinter dem Handschuhfach
- E** El filtro se encuentra en el habitáculo detrás de la guantera

<p>--- Impreza IV ---</p>	<p>03/13 -></p>	<p>*</p>	<p></p>	<p>CK 22004 219 x 235 x 58</p>  <p><u>O/E numbers</u> Subaru 72880FG000-72880FG0009P</p> <p><u>Cross References</u> Fram CF10930 Mann CU22004 Micronair Purflux AH401 Tecocar E692 Fiaam PC8370</p>	
---------------------------	--------------------	----------	---------	---	--



- I** Il filtro è posizionato nell'abitacolo dietro il vano portaoggetti
- GB** The filter is located in the passenger compartment behind the glove compartment
- F** Le filtre est situé dans l'habitacle derrière la boîte à gants
- D** Der filter befindet sich im Fahrgastraum hinter dem Handschuhfach
- E** El filtro se encuentra en el habitáculo detrás de la guantera

<p>--- Justy III ---</p>	<p>12/03 -></p>	<p>*</p>	<p>*</p>	<p>CK 9335 244 x 207 x 17</p>  <p><u>O/E numbers</u> Subaru 9586078F10</p> <p><u>Cross References</u> Fram CF9335 Mann CU2431 Micronair MP077 Purflux AH175 Tecocar E373 Fiaam PC8079</p>	
--------------------------	--------------------	----------	----------	---	--

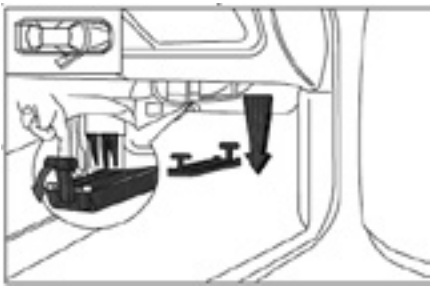

- I** Il filtro è posizionato nell'abitacolo dietro il vano portaoggetti
- GB** The filter is located in the passenger compartment behind the glove compartment
- F** Le filtre est situé dans l'habitacle derrière la boîte à gants
- D** Der filter befindet sich im Fahrgastraum hinter dem Handschuhfach
- E** El filtro se encuentra en el habitáculo detrás de la guantera

<p>--- Justy IV ---</p>	<p>09/07 -></p>	<p>*</p>	<p>*</p>	<p>---</p>	<p>CK 1611-C</p>  <p><u>O/E numbers</u> Subaru.....</p> <p><u>Cross References</u> Fram..... Mann CUK1611 Micronair MC699 Purflux..... Tecocar..... Fiaam.....</p>
-------------------------	--------------------	----------	----------	------------	---

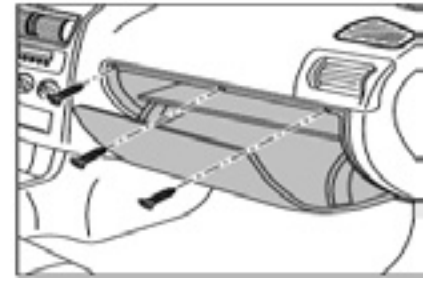

- I** Il filtro è posizionato nell'abitacolo dietro il vano portaoggetti
- GB** The filter is located in the passenger compartment behind the glove compartment
- F** Le filtre est situé dans l'habitacle derrière la boîte à gants
- D** Der filter befindet sich im Fahrgastraum hinter dem Handschuhfach
- E** El filtro se encuentra en el habitáculo detrás de la guantera

<p>--- Legacy III ---</p>	<p>10/03 -></p>	<p>*</p>	<p></p>	<p>CK 9846 215 x 215 x 17</p>  <p><u>O/E numbers</u> Subaru G3210AE000 / 72880AE020</p> <p><u>Cross References</u> Fram CF9846 Mann CU2131 Micronair MP105 Purflux AH210 Tecocar E414 Fiaam PC8144</p>	
---------------------------	--------------------	----------	---------	--	--

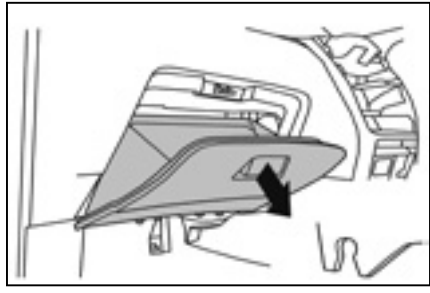



- I** Il filtro è posizionato nell'abitacolo dietro il vano portaoggetti
- GB** The filter is located in the passenger compartment behind the glove compartment
- F** Le filtre est situé dans l'habitacle derrière la boîte à gants
- D** Der filter befindet sich im Fahrgastraum hinter dem Handschuhfach
- E** El filtro se encuentra en el habitáculo detrás de la guantera





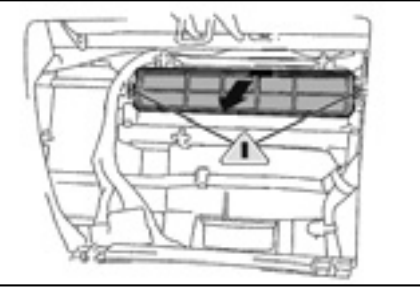

Anti-pollen

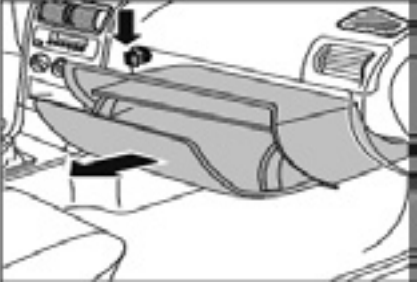

Activated carbon

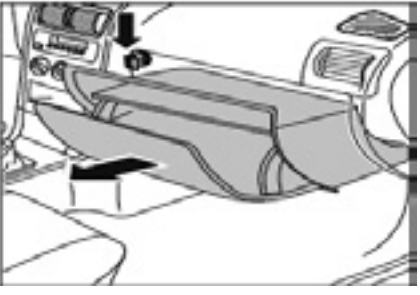

SUBARU

<p>--- Legacy III ---</p> 	<p>02/08 -> <input type="checkbox"/> <input type="checkbox"/></p> <ul style="list-style-type: none"> I Il filtro è posizionato nell'abitacolo dietro il vano portaoggetti GB The filter is located in the passenger compartment behind the glove compartment F Le filtre est situé dans l'habitacle derrière la boîte à gants D Der filter befindet sich im Fahrgastraum hinter dem Handshuhfach E El filtro se encuentra en el habitáculo detrás de la guantera 	<p>CK 9466 215 x 195 x 17</p>  <p><u>O/E numbers</u> Subaru 72880AG000</p> <p><u>Cross References</u> Fram CF9466 Mann CU1828 Micronair MP104 Purflux AH160 Tecocar E359 Fiaam PC8096</p>	<p>---</p>
--	---	---	------------

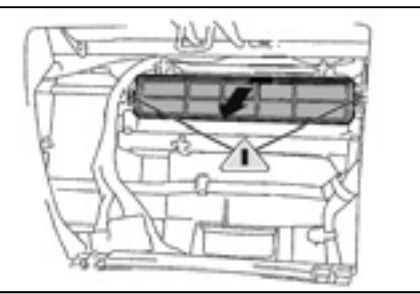
<p>--- Legacy IV ---</p> 	<p>09/09 -> <input type="checkbox"/> * <input type="checkbox"/></p> <ul style="list-style-type: none"> I Il filtro è posizionato nell'abitacolo dietro il vano portaoggetti GB The filter is located in the passenger compartment behind the glove compartment F Le filtre est situé dans l'habitacle derrière la boîte à gants D Der filter befindet sich im Fahrgastraum hinter dem Handshuhfach E El filtro se encuentra en el habitáculo detrás de la guantera 	<p>CK 1919 215 x 193 x 29</p>  <p><u>O/E numbers</u> Subaru SEDNF29110</p> <p><u>Cross References</u> Fram CF10285/CF10322 Mann CU1919 Micronair MP273 Purflux AH256 Tecocar E467 Fiaam PC8186</p>	<p>CK 1919-C 215 x 193 x 29</p>  <p><u>O/E numbers</u> Subaru.....</p> <p><u>Cross References</u> Fram Mann CUK1919 Micronair MC773 Purflux Tecocar Fiaam</p>
---	---	--	--

<p>--- Liberty (BL/BP) ---</p> 	<p>09/09 -> <input type="checkbox"/> * <input type="checkbox"/></p> <ul style="list-style-type: none"> I Il filtro è posizionato nell'abitacolo dietro il vano portaoggetti GB The filter is located in the passenger compartment behind the glove compartment F Le filtre est situé dans l'habitacle derrière la boîte à gants D Der filter befindet sich im Fahrgastraum hinter dem Handshuhfach E El filtro se encuentra en el habitáculo detrás de la guantera 	<p>CK 1919 215 x 193 x 29</p>  <p><u>O/E numbers</u> Subaru SEDNF29110</p> <p><u>Cross References</u> Fram CF10285/CF10322 Mann CU1919 Micronair MP273 Purflux AH256 Tecocar E467 Fiaam PC8186</p>	<p>CK 1919-C 215 x 193 x 29</p>  <p><u>O/E numbers</u> Subaru.....</p> <p><u>Cross References</u> Fram Mann CUK1919 Micronair MC773 Purflux Tecocar Fiaam</p>
---	---	--	--

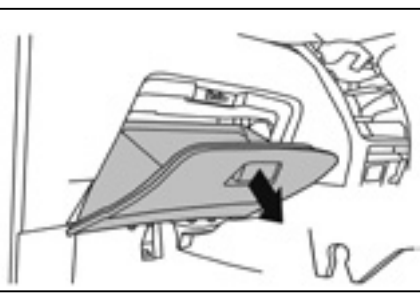
<p>--- Outback II ---</p> 	<p>02/08 -> 09/09 <input type="checkbox"/> * <input type="checkbox"/></p> <ul style="list-style-type: none"> I Il filtro è posizionato nell'abitacolo dietro il vano portaoggetti GB The filter is located in the passenger compartment behind the glove compartment F Le filtre est situé dans l'habitacle derrière la boîte à gants D Der filter befindet sich im Fahrgastraum hinter dem Handshuhfach E El filtro se encuentra en el habitáculo detrás de la guantera 	<p>CK 9466 215 x 195 x 17</p>  <p><u>O/E numbers</u> Subaru 72880AG000</p> <p><u>Cross References</u> Fram CF9466 Mann CU1828 Micronair MP104 Purflux AH160 Tecocar E359 Fiaam PC8096</p>	<p>---</p>
--	---	---	------------

<p>--- Outback II ---</p> 	<p>02/04 -> 09/09 <input type="checkbox"/> * <input type="checkbox"/></p> <ul style="list-style-type: none"> I Il filtro è posizionato nell'abitacolo dietro il vano portaoggetti GB The filter is located in the passenger compartment behind the glove compartment F Le filtre est situé dans l'habitacle derrière la boîte à gants D Der filter befindet sich im Fahrgastraum hinter dem Handshuhfach E El filtro se encuentra en el habitáculo detrás de la guantera 	<p>CK 9846 215 x 215 x 17</p>  <p><u>O/E numbers</u> Subaru G3210AE000 / 72880AE020</p> <p><u>Cross References</u> Fram CF9846 Mann CU2131 Micronair MP105 Purflux AH210 Tecocar E414 Fiaam PC8144</p>	<p>---</p>
--	---	--	------------



Anti-pollen

Activated carbon

SUBARU

--- Outback III ---

09/09 -> * *

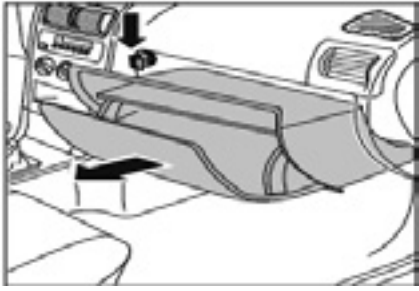

- I** Il filtro è posizionato nell'abitacolo dietro il vano portaoggetti
- GB** The filter is located in the passenger compartment behind the glove compartment
- F** Le filtre est situé dans l'habitacle derrière la boîte à gants
- D** Der filter befindet sich im Fahrgastraum hinter dem Handschuhfach
- E** El filtro se encuentra en el habitáculo detrás de la guantera

CK 1919

215 x 193 x 29



O/E numbers

Subaru SEDNF29110

Cross References

Fram CF10285/CF10322 Mann CU1919
 Micronair MP273 Purflux AH256
 Tecocar E467 Fiaam PC8186

CK 1919-C

215 x 193 x 29



O/E numbers

Subaru.....

Cross References

Fram Mann CUK1919
 Micronair MC773 Purflux
 Tecocar Fiaam

--- Trezia ---

03/11 -> * *

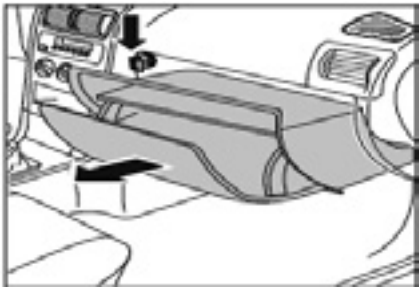

- I** Il filtro è posizionato nell'abitacolo dietro il vano portaoggetti
- GB** The filter is located in the passenger compartment behind the glove compartment
- F** Le filtre est situé dans l'habitacle derrière la boîte à gants
- D** Der filter befindet sich im Fahrgastraum hinter dem Handschuhfach
- E** El filtro se encuentra en el habitáculo detrás de la guantera

CK 1919

215 x 193 x 29



O/E numbers

Subaru SEDNF29110

Cross References

Fram CF10285/CF10322 Mann CU1919
 Micronair MP273 Purflux AH256
 Tecocar E467 Fiaam PC8186

CK 1919-C

215 x 193 x 29



O/E numbers

Subaru.....

Cross References

Fram Mann CUK1919
 Micronair MC773 Purflux
 Tecocar Fiaam

--- Tribeca ---

11/06 -> *



- I** Il filtro è posizionato nell'abitacolo dietro il vano portaoggetti
- GB** The filter is located in the passenger compartment behind the glove compartment
- F** Le filtre est situé dans l'habitacle derrière la boîte à gants
- D** Der filter befindet sich im Fahrgastraum hinter dem Handschuhfach
- E** El filtro se encuentra en el habitáculo detrás de la guantera

CK 9846

215 x 215 x 17



O/E numbers

Subaru G3210AE000 / 72880AE020

Cross References

Fram CF9846 Mann CU2131
 Micronair MP105 Purflux AH210
 Tecocar E414 Fiaam PC8144

--- XV ---

03/12 -> *



- I** Il filtro è posizionato nell'abitacolo dietro il vano portaoggetti
- GB** The filter is located in the passenger compartment behind the glove compartment
- F** Le filtre est situé dans l'habitacle derrière la boîte à gants
- D** Der filter befindet sich im Fahrgastraum hinter dem Handschuhfach
- E** El filtro se encuentra en el habitáculo detrás de la guantera

CK 22004

219 x 235 x 58



O/E numbers









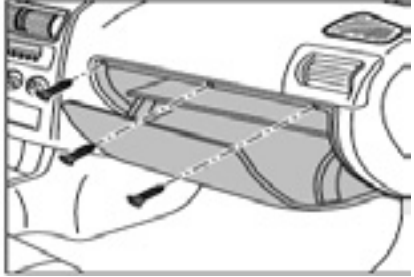

Subaru 72880FG000-72880FG0009P

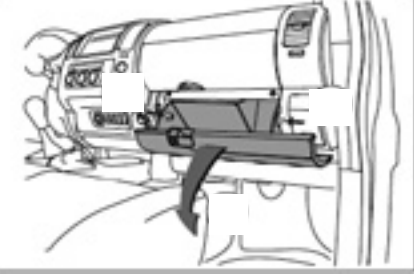
Cross References

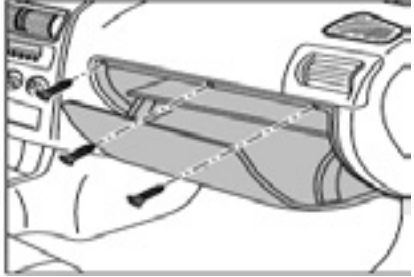
Fram CF10930 Mann CU22004
 Micronair Purflux AH401
 Tecocar E692 Fiaam PC8370

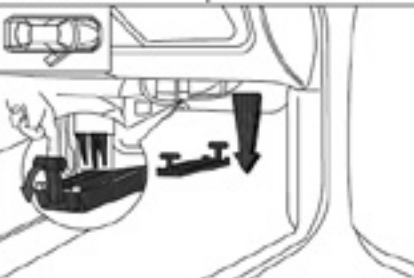

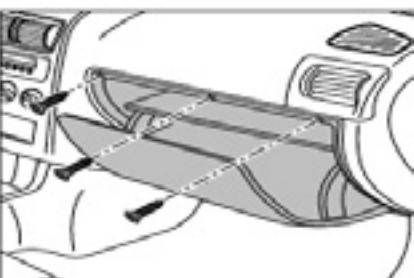
SUZUKI









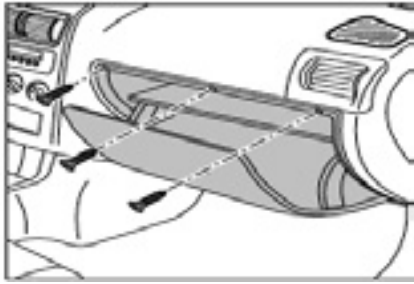

<p>--- S-Cross ---</p>  <ul style="list-style-type: none"> I Il filtro è posizionato nell'abitacolo dietro il vano portaoggetti GB The filter is located in the passenger compartment behind the glove compartment F Le filtre est situé dans l'habitacle derrière la boîte à gants D Der filter befindet sich im Fahrgastraum hinter dem Handschuhfach E El filtro se encuentra en el habitáculo detrás de la guantera 	<p>11/13 -> * <input type="checkbox"/></p>	<p>CK 22023 213 x 190 x 30</p>  <p><u>O/E numbers</u> Suzuki 9585061M00</p> <p><u>Cross References</u> Fram CF11862 Mann CU2145 Micronair MP225 Purflux AH484 Tecnocar E726 Fiaam PC8420</p>	<p>---</p>
<p>--- Alto ---</p>  <ul style="list-style-type: none"> I Il filtro è posizionato nell'abitacolo dietro il vano portaoggetti GB The filter is located in the passenger compartment behind the glove compartment F Le filtre est situé dans l'habitacle derrière la boîte à gants D Der filter befindet sich im Fahrgastraum hinter dem Handschuhfach E El filtro se encuentra en el habitáculo detrás de la guantera 	<p>06/02 -> <input type="checkbox"/></p>	<p>CK 17001 192 x 165 x 20</p>  <p><u>O/E numbers</u> Suzuki 95861M68K10</p> <p><u>Cross References</u> Fram CF10823 Mann CU17001 Micronair MP399 Purflux AH291 Tecnocar E608 Fiaam PC8257</p>	<p>---</p>
<p>--- Grand Vitara ---</p>  <ul style="list-style-type: none"> I Il filtro è posizionato nell'abitacolo dietro il vano portaoggetti GB The filter is located in the passenger compartment behind the glove compartment F Le filtre est situé dans l'habitacle derrière la boîte à gants D Der filter befindet sich im Fahrgastraum hinter dem Handschuhfach E El filtro se encuentra en el habitáculo detrás de la guantera 	<p>10/05 -> * <input type="checkbox"/></p>	<p>CK 2138 271 x 203 x 20</p>  <p><u>O/E numbers</u> Suzuki 9586164J00</p> <p><u>Cross References</u> Fram CF11261 Mann CU2138 Micronair MP272 Purflux AH350 Tecnocar E643 Fiaam PC8308</p>	<p>CK 2138-C 271 x 203 x 20</p>  <p><u>O/E numbers</u> Suzuki 9586164J00000</p> <p><u>Cross References</u> Fram Mann Micronair MC772 Purflux Tecnocar Fiaam</p>
<p>--- Ignis II ---</p>  <ul style="list-style-type: none"> I Il filtro è posizionato nell'abitacolo sotto il vano portaoggetti GB The filter is located in the passenger compartment under the glove compartment F Le filtre est situé dans l'habitacle en dessous de la boîte à gants D Der filter befindet sich im Fahrgastraum unter dem Handschuhfach E El filtro se encuentra en el habitáculo, bajo la guantera en el compartimiento de pasajeros 	<p>12/03 -> * <input type="checkbox"/></p>	<p>CK 9335 244 x 207 x 17</p>  <p><u>O/E numbers</u> Suzuki 9586078F000</p> <p><u>Cross References</u> Fram CF9335 Mann CU2431 Micronair MP077 Purflux AH175 Tecnocar E373 Fiaam PC8079</p>	<p>---</p>
<p>--- Spalsh ---</p>  <ul style="list-style-type: none"> I Il filtro è posizionato nell'abitacolo dietro il vano portaoggetti GB The filter is located in the passenger compartment behind the glove compartment F Le filtre est situé dans l'habitacle derrière la boîte à gants D Der filter befindet sich im Fahrgastraum hinter dem Handschuhfach E El filtro se encuentra en el habitáculo detrás de la guantera 	<p>05/08 -> <input type="checkbox"/></p>	<p>CK 2028-10 198 x 142 x 29,5</p>  <p><u>O/E numbers</u> Suzuki 9586051K00</p> <p><u>Cross References</u> Fram CF11244 Mann CU2028 Micronair MP326 Purflux AH343 Tecnocar E636 Fiaam PC8300</p>	<p>---</p>

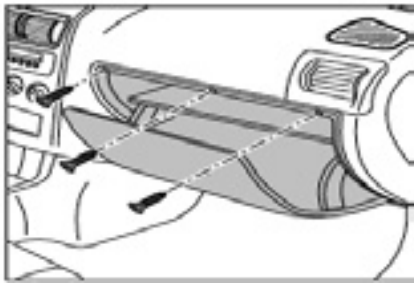

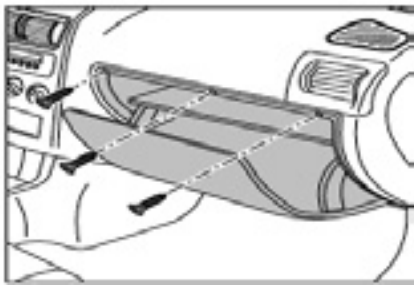
Anti-pollen

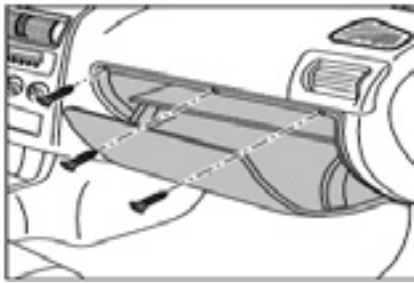
Activated carbon

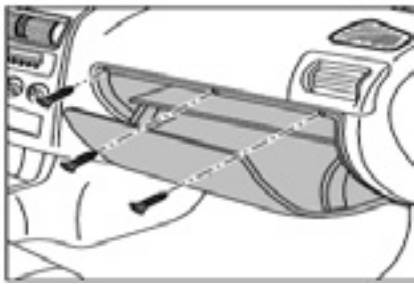
SUZUKI

<p>--- Swift III ---</p> 	<p>05/05 -> 08/10</p>	<p>*</p>	<p>*</p>	<p>CK 1827 185 x 180 x 30</p>  <p><u>O/E numbers</u> Suzuki 9586062J00000</p> <p><u>Cross References</u> Fram CF10202 Mann CU1827 Micronair MP198 Purflux AH249 Tecnocar E457 Fiaam PC8176</p>	<p>---</p>
<p>--- Swift IV ---</p> 	<p>09/10 -></p>	<p>*</p>	<p>*</p>	<p>CK 1827 185 x 180 x 30</p>  <p><u>O/E numbers</u> Suzuki 9586062J00000</p> <p><u>Cross References</u> Fram CF10202 Mann CU1827 Micronair MP198 Purflux AH249 Tecnocar E457 Fiaam PC8176</p>	<p>---</p>
<p>--- SX4 ---</p> 	<p>05/06 -></p>	<p>*</p>	<p>*</p>	<p>CK 1827 185 x 180 x 30</p>  <p><u>O/E numbers</u> Suzuki 9586062J00000</p> <p><u>Cross References</u> Fram CF10202 Mann CU1827 Micronair MP198 Purflux AH249 Tecnocar E457 Fiaam PC8176</p>	<p>---</p>
<p>--- SX4 S-Cross ---</p> 	<p>11/13 -></p>	<p>*</p>	<p></p>	<p>CK 22023 213 x 190 x 30</p>  <p><u>O/E numbers</u> Suzuki 9585061M00</p> <p><u>Cross References</u> Fram CF11862 Mann CU2145 Micronair MP225 Purflux AH484 Tecnocar E726 Fiaam PC8420</p>	<p>---</p>
<p>--- Vitara II ---</p> 	<p>02/15 -></p>	<p>*</p>	<p></p>	<p>CK 22023 213 x 190 x 30</p>  <p><u>O/E numbers</u> Suzuki 9585061M00</p> <p><u>Cross References</u> Fram CF11862 Mann CU2145 Micronair MP225 Purflux AH484 Tecnocar E726 Fiaam PC8420</p>	<p>---</p>



Anti-pollen

Activated carbon

SUZUKI

--- Wagon R+ ---

07/03 ->

*

CK 9335

244 x 207 x 17

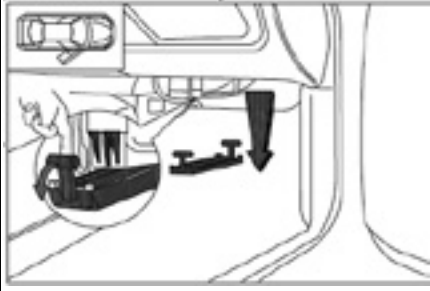

- Il filtro è posizionato nell'abitacolo sotto il vano portaoggetti
- The filter is located in the passenger compartment under the glove compartment
- Le filtre est situé dans l'habitacle en dessous de la boîte à gants
- Der filter befindet sich im Fahrgastraum unter dem Handshuhfach
- El filtro se encuentra en el habitáculo, bajo la guanterain de pasajerruimte

O/E numbers

Suzuki 9586078F000

Cross References

Fram CF9335	Mann CU2431
Micronair MP077	Purflux AH175
Tecnocar E373	Fiaam PC8079

--	--	--

--	--	--

--	--	--

--	--	--



Anti-pollen

Activated carbon

TOYOTA

--- Alphard II ---

04/08 ->

*

*

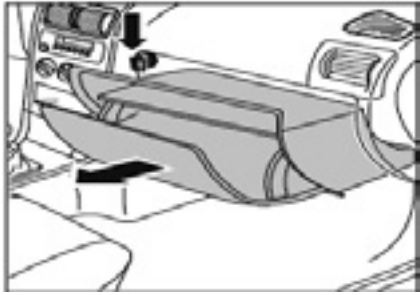

- I** Il filtro è posizionato nell'abitacolo dietro il vano portaoggetti
- GB** The filter is located in the passenger compartment behind the glove compartment
- F** Le filtre est situé dans l'habitacle derrière la boîte à gants
- D** Der filter befindet sich im Fahrgastraum hinter dem Handschuhfach
- E** El filtro se encuentra en el habitáculo detrás de la guantera

CK 1919

215 x 193 x 29



O/E numbers

Toyota 8713902020 - 871390D010

Cross References

Fram CF10285/CF10322 Mann CU1919
Micronair MP273 Purflux AH256
Tecocar E467 Fiaam PC8186

CK 1919-C

215 x 193 x 29



O/E numbers

Toyota 8713950060 - 8713952020

Cross References

Fram Mann CUK1919
Micronair MC773 Purflux
Tecocar Fiaam

--- Auris I ---

02/07 ->

*

*

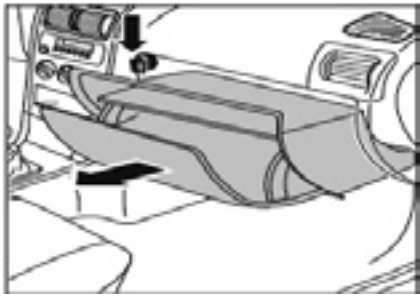

- I** Il filtro è posizionato nell'abitacolo dietro il vano portaoggetti
- GB** The filter is located in the passenger compartment behind the glove compartment
- F** Le filtre est situé dans l'habitacle derrière la boîte à gants
- D** Der filter befindet sich im Fahrgastraum hinter dem Handschuhfach
- E** El filtro se encuentra en el habitáculo detrás de la guantera

CK 1919

215 x 193 x 29



O/E numbers

Toyota 8713902020 - 871390D010

Cross References

Fram CF10285/CF10322 Mann CU1919
Micronair MP273 Purflux AH256
Tecocar E467 Fiaam PC8186

CK 1919-C

215 x 193 x 29



O/E numbers

Toyota 8713950060 - 8713952020

Cross References

Fram Mann CUK1919
Micronair MC773 Purflux
Tecocar Fiaam

--- Auris II ---

10/12 ->

*

*

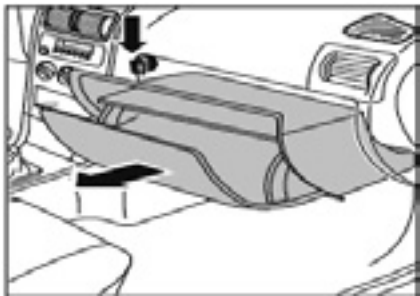

- I** Il filtro è posizionato nell'abitacolo dietro il vano portaoggetti
- GB** The filter is located in the passenger compartment behind the glove compartment
- F** Le filtre est situé dans l'habitacle derrière la boîte à gants
- D** Der filter befindet sich im Fahrgastraum hinter dem Handschuhfach
- E** El filtro se encuentra en el habitáculo detrás de la guantera

CK 1919

215 x 193 x 29



O/E numbers

Toyota 8713902020 - 871390D010

Cross References

Fram CF10285/CF10322 Mann CU1919
Micronair MP273 Purflux AH256
Tecocar E467 Fiaam PC8186

CK 1919-C

215 x 193 x 29



O/E numbers

Toyota 8713950060 - 8713952020

Cross References

Fram Mann CUK1919
Micronair MC773 Purflux
Tecocar Fiaam

--- Avensis I ---

09/97 -> 02/03

*

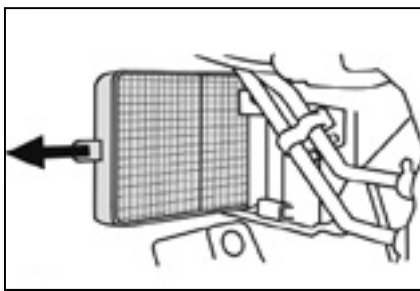

- I** Il filtro è posizionato nell'abitacolo dietro il vano portaoggetti
- GB** The filter is located in the passenger compartment behind the glove compartment
- F** Le filtre est situé dans l'habitacle derrière la boîte à gants
- D** Der filter befindet sich im Fahrgastraum hinter dem Handschuhfach
- E** El filtro se encuentra en el habitáculo detrás de la guantera

CK 9740-2

229 x 149 x 19,5



O/E numbers

Toyota 8888020060 / 8888020110

Cross References

Fram CF9740 Mann CU21001-2
Micronair MP128-2 Purflux AH151
Tecocar E349 Fiaam PC8131

--- Avensis II ---

03/03 -> 11/09

*

*

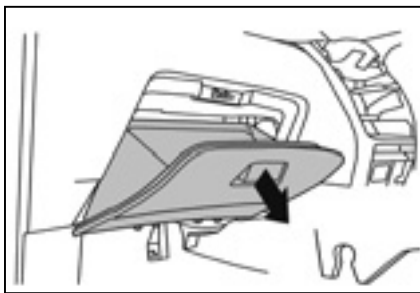

- I** Il filtro è posizionato nell'abitacolo dietro il vano portaoggetti
- GB** The filter is located in the passenger compartment behind the glove compartment
- F** Le filtre est situé dans l'habitacle derrière la boîte à gants
- D** Der filter befindet sich im Fahrgastraum hinter dem Handschuhfach
- E** El filtro se encuentra en el habitáculo detrás de la guantera

CK 9686

220 x 198 x 20



O/E numbers

Toyota 8856802030 / 87139YZZ07

Cross References



Fram CF9686 Mann CU2035
Micronair MP117 Purflux AH189
Tecocar E392 Fiaam PC8126





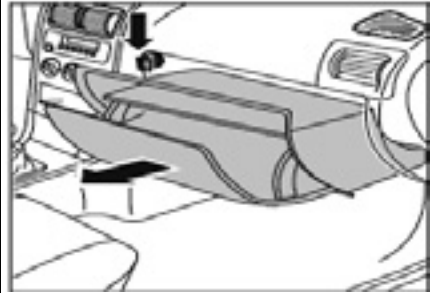

Anti-pollen

Activated carbon

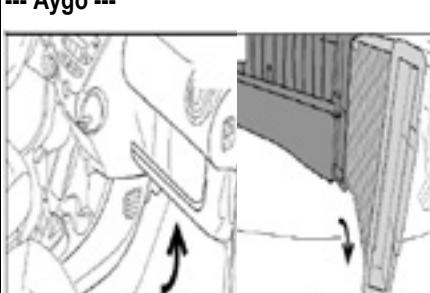

TOYOTA

<p>--- Avensis III ---</p>  <p>Il filtro è posizionato nell'abitacolo dietro il vano portaoggetti The filter is located in the passenger compartment behind the glove compartment Le filtre est situé dans l'habitacle derrière la boîte à gants Der filter befindet sich im Fahrgastraum hinter dem Handschuhfach El filtro se encuentra en el habitáculo detrás de la guantera</p>	<p>01/09 -></p>	<p>* *</p>	<p>CK 1919 215 x 193 x 29</p>  <p><u>O/E numbers</u> Toyota 8713902020 - 871390D010</p> <p><u>Cross References</u> Fram CF10285/CF10322 Mann CU1919 Micronair MP273 Purflux AH256 Tecocar E467 Fiaam PC8186</p>	<p>CK 1919-C 215 x 193 x 29</p>  <p><u>O/E numbers</u> Toyota 8713950060 - 8713952020</p> <p><u>Cross References</u> Fram Mann CUK1919 Micronair MC773 Purflux Tecocar Fiaam</p>
--	--------------------	------------	--	--

<p>--- Avensis Verso ---</p>  <p>Il filtro è posizionato nell'abitacolo dietro il vano portaoggetti The filter is located in the passenger compartment behind the glove compartment Le filtre est situé dans l'habitacle derrière la boîte à gants Der filter befindet sich im Fahrgastraum hinter dem Handschuhfach El filtro se encuentra en el habitáculo detrás de la guantera</p>	<p>08/01 -> 11/09</p>	<p>* *</p>	<p>CK 9846 215 x 215 x 17</p>  <p><u>O/E numbers</u> Toyota 8713947010 / 8713947010-83</p> <p><u>Cross References</u> Fram CF9846 Mann CU2131 Micronair MP105 Purflux AH210 Tecocar E414 Fiaam PC8144</p>	<p>---</p>
--	--------------------------	------------	--	------------

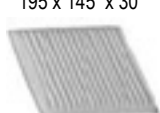
<p>--- Aygo ---</p>  <p>Il filtro è posizionato nell'abitacolo dietro il vano portaoggetti The filter is located in the passenger compartment behind the glove compartment Le filtre est situé dans l'habitacle derrière la boîte à gants Der filter befindet sich im Fahrgastraum hinter dem Handschuhfach El filtro se encuentra en el habitáculo detrás de la guantera</p>	<p>07/05 -></p>	<p></p>	<p>CK 207 225/215 x 164/150.5 x 44</p>  <p><u>O/E numbers</u> Toyota 885080H010</p> <p><u>Cross References</u> Fram CF10080 Mann CU2317 Micronair MP207 Purflux AH223 Tecocar E440 Fiaam PC8243</p>	<p>---</p>
---	--------------------	---------	--	------------

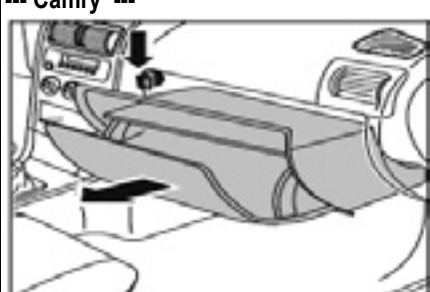
<p>--- Aygo II ---</p>  <p>Il filtro è posizionato nell'abitacolo dietro il vano portaoggetti The filter is located in the passenger compartment behind the glove compartment Le filtre est situé dans l'habitacle derrière la boîte à gants Der filter befindet sich im Fahrgastraum hinter dem Handschuhfach El filtro se encuentra en el habitáculo detrás de la guantera</p>	<p>05/14 -></p>	<p></p>	<p>CK 20013 195 x 145 x 30</p>  <p><u>O/E numbers</u> Toyota 88508YV010</p> <p><u>Cross References</u> Fram Mann CU20013 Micronair Purflux Tecocar Fiaam</p>	<p>---</p>
--	--------------------	---------	---	------------

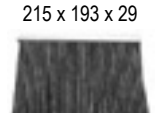







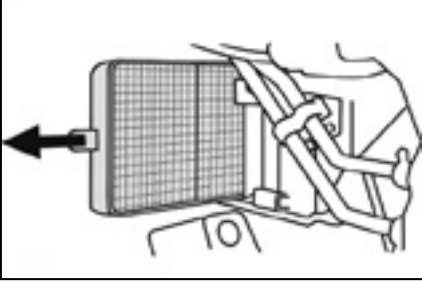

<p>--- Camry ---</p>  <p>Il filtro è posizionato nell'abitacolo dietro il vano portaoggetti The filter is located in the passenger compartment behind the glove compartment Le filtre est situé dans l'habitacle derrière la boîte à gants Der filter befindet sich im Fahrgastraum hinter dem Handschuhfach El filtro se encuentra en el habitáculo detrás de la guantera</p>	<p>01/06 -></p>	<p>* *</p>	<p>CK 1919 215 x 193 x 29</p>  <p><u>O/E numbers</u> Toyota 8713902020 - 871390D010</p> <p><u>Cross References</u> Fram CF10285/CF10322 Mann CU1919 Micronair MP273 Purflux AH256 Tecocar E467 Fiaam PC8186</p>	<p>CK 1919-C 215 x 193 x 29</p>  <p><u>O/E numbers</u> Toyota 8713950060 - 8713952020</p> <p><u>Cross References</u> Fram Mann CUK1919 Micronair MC773 Purflux Tecocar Fiaam</p>
--	--------------------	------------	--	--

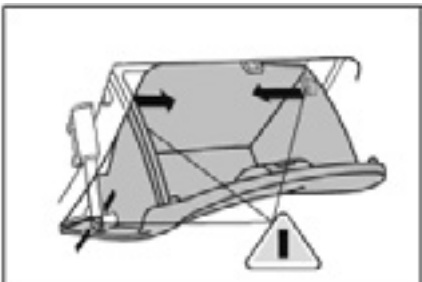

Anti-pollen

Activated carbon

TOYOTA



<p>--- Carina E ---</p> 	<p>04/92 -> 10/97</p> <p style="text-align: center;">*</p>	<p>CK 9740-2 229 x 149 x 19,5</p>  <p><u>O/E numbers</u> Toyota 8888020060 / 8888020110</p> <p><u>Cross References</u> Fram CF9740 Mann CU21001-2 Micronair MP128-2 Purflux AH151 Tecnocar E349 Fiaam PC8131</p>	<p>---</p>
<p>--- Celica ---</p> 	<p>11/99 -> 12/05</p>	<p>CK 9846 215 x 215 x 17</p>  <p><u>O/E numbers</u> Toyota 8713947010 / 8713947010-83</p> <p><u>Cross References</u> Fram CF9846 Mann CU2131 Micronair MP105 Purflux AH210 Tecnocar E414 Fiaam PC8144</p>	<p>---</p>
<p>--- Corolla VIII ---</p> 	<p>04/97 -> 12/01</p>	<p>CK 9659 218/198 x203 x 20</p>  <p><u>O/E numbers</u> Toyota 8850812010</p> <p><u>Cross References</u> Fram CF9659 Mann CU2015 Micronair MP129 Purflux AH295 Tecnocar..... Fiaam PC8125</p>	<p>---</p>
<p>--- Corolla IX ---</p> 	<p>01/02 -> 03/09</p> <p style="text-align: center;">* *</p>	<p>CK 9686 220 x 198 x 20</p>  <p><u>O/E numbers</u> Toyota 8856802030 / 87139YZZ07</p> <p><u>Cross References</u> Fram CF9686 Mann CU2035 Micronair MP117 Purflux AH189 Tecnocar E392 Fiaam PC8126</p>	<p>---</p>
<p>--- Corolla IX Verso ---</p> 	<p>01/02 -> 03/09</p> <p style="text-align: center;">* *</p>	<p>CK 9686 220 x 198 x 20</p>  <p><u>O/E numbers</u> Toyota 8856802030 / 87139YZZ07</p> <p><u>Cross References</u> Fram CF9686 Mann CU2035 Micronair MP117 Purflux AH189 Tecnocar E392 Fiaam PC8126</p>	<p>---</p>





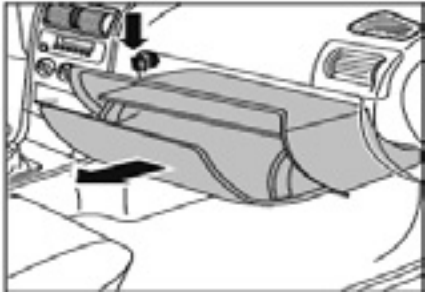

Anti-pollen

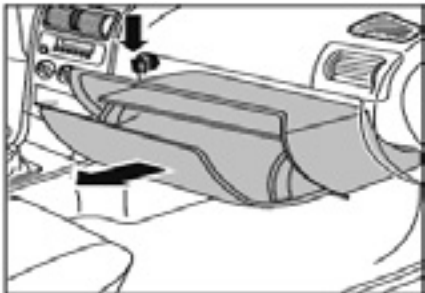

Activated carbon

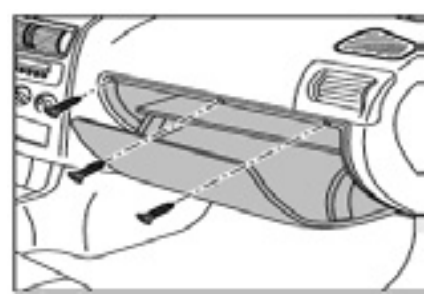

TOYOTA

<p>--- Corolla X ---</p>  <p>02/07 -> * *</p> <p> I Il filtro è posizionato nell'abitacolo dietro il vano portaoggetti GB The filter is located in the passenger compartment behind the glove compartment F Le filtre est situé dans l'habitacle derrière la boîte à gants D Der filter befindet sich im Fahrgastraum hinter dem Handschuhfach E El filtro se encuentra en el habitáculo detrás de la guantera </p>	<p>CK 1919</p> <p>215 x 193 x 29</p>  <p><u>O/E numbers</u> Toyota 8713902020 - 871390D010</p> <p><u>Cross References</u> Fram CF10285/CF10322 Mann CU1919 Micronair MP273 Purflux AH256 Tecocar E467 Fiaam PC8186</p>	<p>CK 1919-C</p> <p>215 x 193 x 29</p>  <p><u>O/E numbers</u> Toyota 8713950060 - 8713952020</p> <p><u>Cross References</u> Fram Mann CUK1919 Micronair MC773 Purflux Tecocar Fiaam</p>
---	--	--

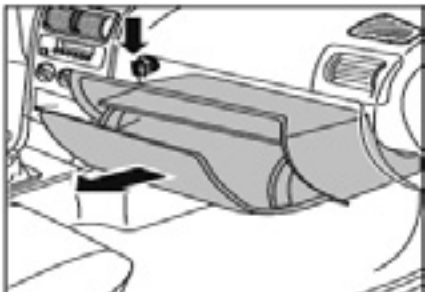
<p>--- Corolla XI ---</p>  <p>06/13 -> * *</p> <p> I Il filtro è posizionato nell'abitacolo dietro il vano portaoggetti GB The filter is located in the passenger compartment behind the glove compartment F Le filtre est situé dans l'habitacle derrière la boîte à gants D Der filter befindet sich im Fahrgastraum hinter dem Handschuhfach E El filtro se encuentra en el habitáculo detrás de la guantera </p>	<p>CK 1919</p> <p>215 x 193 x 29</p>  <p><u>O/E numbers</u> Toyota 8713902020 - 871390D010</p> <p><u>Cross References</u> Fram CF10285/CF10322 Mann CU1919 Micronair MP273 Purflux AH256 Tecocar E467 Fiaam PC8186</p>	<p>CK 1919-C</p> <p>215 x 193 x 29</p>  <p><u>O/E numbers</u> Toyota 8713950060 - 8713952020</p> <p><u>Cross References</u> Fram Mann CUK1919 Micronair MC773 Purflux Tecocar Fiaam</p>
--	--	--

<p>--- GT86 ---</p>  <p>06/12 -> * *</p> <p> I Il filtro è posizionato nell'abitacolo dietro il vano portaoggetti GB The filter is located in the passenger compartment behind the glove compartment F Le filtre est situé dans l'habitacle derrière la boîte à gants D Der filter befindet sich im Fahrgastraum hinter dem Handschuhfach E El filtro se encuentra en el habitáculo detrás de la guantera </p>	<p>CK 1827</p> <p>185 x 180 x 30</p>  <p><u>O/E numbers</u> Toyota</p> <p><u>Cross References</u> Fram CF10202 Mann CU1827 Micronair MP198 Purflux AH249 Tecocar E457 Fiaam PC8176</p>	<p>---</p>
--	--	------------

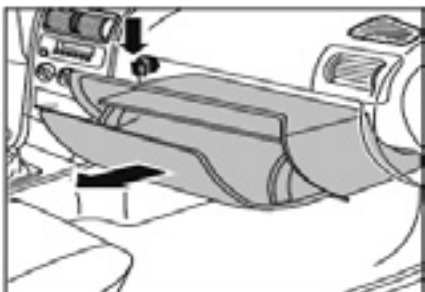
<p>--- Highlander II ---</p>  <p>09/07 -> * *</p> <p> I Il filtro è posizionato nell'abitacolo dietro il vano portaoggetti GB The filter is located in the passenger compartment behind the glove compartment F Le filtre est situé dans l'habitacle derrière la boîte à gants D Der filter befindet sich im Fahrgastraum hinter dem Handschuhfach E El filtro se encuentra en el habitáculo detrás de la guantera </p>	<p>CK 1919</p> <p>215 x 193 x 29</p>  <p><u>O/E numbers</u> Toyota 8713902020 - 871390D010</p> <p><u>Cross References</u> Fram CF10285/CF10322 Mann CU1919 Micronair MP273 Purflux AH256 Tecocar E467 Fiaam PC8186</p>	<p>CK 1919-C</p> <p>215 x 193 x 29</p>  <p><u>O/E numbers</u> Toyota 8713950060 - 8713952020</p> <p><u>Cross References</u> Fram Mann CUK1919 Micronair MC773 Purflux Tecocar Fiaam</p>
---	--	--

<p>--- Hi-Lux ---</p>  <p>10/05 -> * *</p> <p> I Il filtro è posizionato nell'abitacolo dietro il vano portaoggetti GB The filter is located in the passenger compartment behind the glove compartment F Le filtre est situé dans l'habitacle derrière la boîte à gants D Der filter befindet sich im Fahrgastraum hinter dem Handschuhfach E El filtro se encuentra en el habitáculo detrás de la guantera </p>	<p>CK 1919</p> <p>215 x 193 x 29</p>  <p><u>O/E numbers</u> Toyota 8713902020 - 871390D010</p> <p><u>Cross References</u> Fram CF10285/CF10322 Mann CU1919 Micronair MP273 Purflux AH256 Tecocar E467 Fiaam PC8186</p>	<p>CK 1919-C</p> <p>215 x 193 x 29</p>  <p><u>O/E numbers</u> Toyota 8713950060 - 8713952020</p> <p><u>Cross References</u> Fram Mann CUK1919 Micronair MC773 Purflux Tecocar Fiaam</p>
--	--	--







Anti-pollen

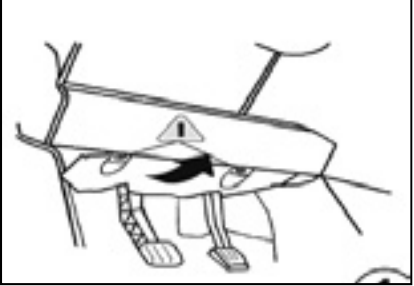
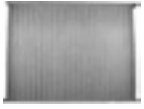

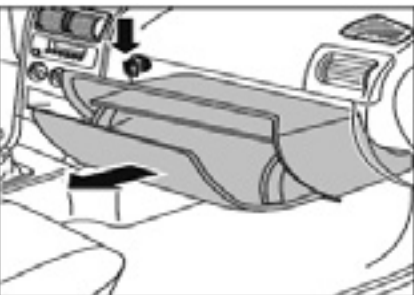
Activated carbon



TOYOTA

<p>---IQ ---</p> 	<p>01/09 -> * *</p>	<p>CK 1827 273 x 198 x 10</p>  <p><u>O/E numbers</u> Toyota 8856874010 - 8856874011</p> <p><u>Cross References</u> Fram CF10763 Mann CU28004 Micronair MP257 Purflux AH285 Tecnicar E600 Fiaam PC8254</p>	<p>---</p>
---	------------------------	--	------------

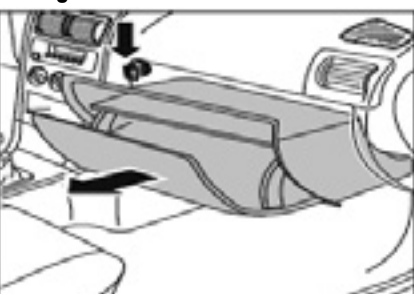
<p>--- Kluger ---</p> 	<p>05/07 -> * *</p>	<p>CK 1919 215 x 193 x 29</p>  <p><u>O/E numbers</u> Toyota 8713902020 - 871390D010</p> <p><u>Cross References</u> Fram CF10285/CF10322 Mann CU1919 Micronair MP273 Purflux AH256 Tecnicar E467 Fiaam PC8186</p>	<p>CK 1919-C 215 x 193 x 29</p>  <p><u>O/E numbers</u> Toyota 8713950060 - 8713952020</p> <p><u>Cross References</u> Fram Mann CUK1919 Micronair MC773 Purflux Tecnicar Fiaam</p>
--	------------------------	---	---

<p>--- Land Cruiser ---</p> 	<p>01/03 -> 02/10 * </p>	<p>CK 9846 215 x 215 x 17</p>  <p><u>O/E numbers</u> Toyota 8713947010 / 8713947010-83</p> <p><u>Cross References</u> Fram CF9846 Mann CU2131 Micronair MP105 Purflux AH210 Tecnicar E414 Fiaam PC8144</p>	<p>---</p>
--	-----------------------------	---	------------

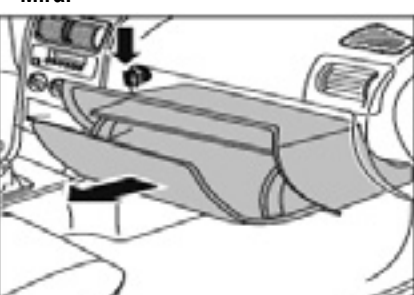
<p>--- Kluger ---</p> 	<p>01/10 -> * *</p>	<p>CK 1919 215 x 193 x 29</p>  <p><u>O/E numbers</u> Toyota 8713902020 - 871390D010</p> <p><u>Cross References</u> Fram CF10285/CF10322 Mann CU1919 Micronair MP273 Purflux AH256 Tecnicar E467 Fiaam PC8186</p>	<p>CK 1919-C 215 x 193 x 29</p>  <p><u>O/E numbers</u> Toyota 8713950060 - 8713952020</p> <p><u>Cross References</u> Fram Mann CUK1919 Micronair MC773 Purflux Tecnicar Fiaam</p>
--	------------------------	---	---

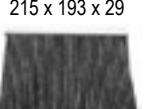

<p>--- Mirai ---</p> 	<p>06/15 -> * *</p>	<p>CK 1919 215 x 193 x 29</p>  <p><u>O/E numbers</u> Toyota 8713902020 - 871390D010</p> <p><u>Cross References</u> Fram CF10285/CF10322 Mann CU1919 Micronair MP273 Purflux AH256 Tecnicar E467 Fiaam PC8186</p>	<p>CK 1919-C 215 x 193 x 29</p>  <p><u>O/E numbers</u> Toyota 8713950060 - 8713952020</p> <p><u>Cross References</u> Fram Mann CUK1919 Micronair MC773 Purflux Tecnicar Fiaam</p>
---	------------------------	---	---





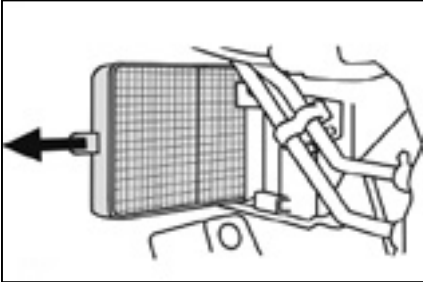

Anti-pollen



Activated carbon

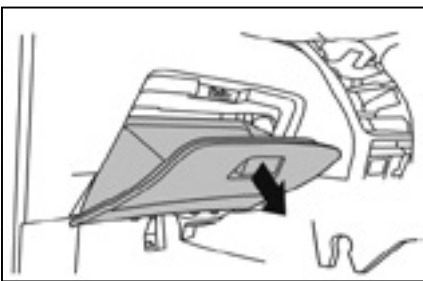

TOYOTA

<p>--- Picnic ---</p> 	<p>05/96 -> 11/01</p> <p>* *</p>	<p>CK 9740-2 229 x 149 x 19,5</p>  <p><u>O/E numbers</u> Toyota 8888020060 / 8888020110</p> <p><u>Cross References</u> Fram CF9740 Mann CU21001-2 Micronair MP128-2 Purflux AH151 Tecnocar E349 Fiaam PC8131</p>	<p>---</p>
--	-------------------------------------	--	------------

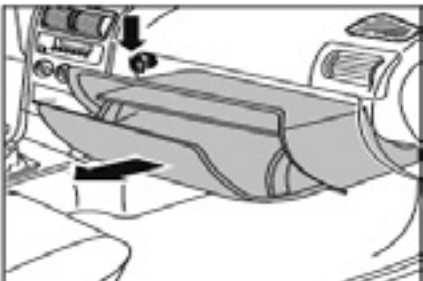
<p>--- Previa ---</p> 	<p>10/99 -></p> <p>* *</p>	<p>CK 9846 215 x 215 x 17</p>  <p><u>O/E numbers</u> Toyota 8713947010 / 8713947010-83</p> <p><u>Cross References</u> Fram CF9846 Mann CU2131 Micronair MP105 Purflux AH210 Tecnocar E414 Fiaam PC8144</p>	<p>---</p>
--	-------------------------------	--	------------

<p>--- Prius ---</p> 	<p>05/00 -> 03/09</p> <p>* *</p>	<p>CK 9846 215 x 215 x 17</p>  <p><u>O/E numbers</u> Toyota 8713947010 / 8713947010-83</p> <p><u>Cross References</u> Fram CF9846 Mann CU2131 Micronair MP105 Purflux AH210 Tecnocar E414 Fiaam PC8144</p>	<p>---</p>
---	-------------------------------------	--	------------

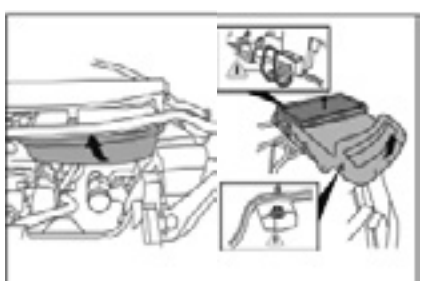
<p>--- Prius ---</p> 	<p>06/09 -></p> <p>* *</p>	<p>CK 1919 215 x 193 x 29</p>  <p><u>O/E numbers</u> Toyota 8713902020 - 871390D010</p> <p><u>Cross References</u> Fram CF10285/CF10322 Mann CU1919 Micronair MP273 Purflux AH256 Tecnocar E467 Fiaam PC8186</p>	<p>CK 1919-C 215 x 193 x 29</p>  <p><u>O/E numbers</u> Toyota 8713950060 - 8713952020</p> <p><u>Cross References</u> Fram Mann CUK1919 Micronair MC773 Purflux Tecnocar Fiaam</p>
---	-------------------------------	--	--

<p>--- Proace ---</p> 	<p>01/07 -></p> <p>* </p>	<p>CK 10366-10 375 x 175 x 48</p>  <p><u>O/E numbers</u> Toyota SU001A13881</p> <p><u>Cross References</u> Fram Mann CU3847 Micronair MP300 Purflux Tecnocar Fiaam</p>	<p>CK 10366-10-C 375 x 175 x 48</p>  <p><u>O/E numbers</u> Toyota</p> <p><u>Cross References</u> Fram CFA10366 Mann CUK3847 Micronair MC800 Purflux AHC258 Tecnocar EC464 Fiaam PCK8193</p>
--	------------------------------	--	--



Anti-pollen

Activated carbon

TOYOTA

<p>--- Rav 4 II ---</p>	06/00 -> 02/06	*	*	<p>CK 9466 215 x 195 x 17</p> <p><u>O/E numbers</u> Toyota 0897400820 - 8856852010</p> <p><u>Cross References</u> Fram CF9466 Mann CU1828 Micronair MP104 Purflux AH160 Tecnocar E359 Fiaam PC8096</p>	
	<p>I Il filtro è posizionato nell'abitacolo dietro il vano portaoggetti</p> <p>GB The filter is located in the passenger compartment behind the glove compartment</p> <p>F Le filtre est situé dans l'habitacle derrière la boîte à gants</p> <p>D Der filter befindet sich im Fahrgastraum hinter dem Handschuhfach</p> <p>E El filtro se encuentra en el habitáculo detrás de la guantera</p>				

<p>--- Rav 4 II ---</p>	03/06 ->	*	*	<p>CK 1919 215 x 193 x 29</p> <p><u>O/E numbers</u> Toyota 8713902020 - 871390D010</p> <p><u>Cross References</u> Fram CF10285/CF10322 Mann CU1919 Micronair MP273 Purflux AH256 Tecnocar E467 Fiaam PC8186</p>	<p>CK 1919-C 215 x 193 x 29</p> <p><u>O/E numbers</u> Toyota 8713950060 - 8713952020</p> <p><u>Cross References</u> Fram Mann CUK1919 Micronair MC773 Purflux Tecnocar Fiaam</p>
	<p>I Il filtro è posizionato nell'abitacolo dietro il vano portaoggetti</p> <p>GB The filter is located in the passenger compartment behind the glove compartment</p> <p>F Le filtre est situé dans l'habitacle derrière la boîte à gants</p> <p>D Der filter befindet sich im Fahrgastraum hinter dem Handschuhfach</p> <p>E El filtro se encuentra en el habitáculo detrás de la guantera</p>				

<p>--- Rav 4 III ---</p>	11/05 ->	*	*	<p>CK 1919 215 x 193 x 29</p> <p><u>O/E numbers</u> Toyota 8713902020 - 871390D010</p> <p><u>Cross References</u> Fram CF10285/CF10322 Mann CU1919 Micronair MP273 Purflux AH256 Tecnocar E467 Fiaam PC8186</p>	<p>CK 1919-C 215 x 193 x 29</p> <p><u>O/E numbers</u> Toyota 8713950060 - 8713952020</p> <p><u>Cross References</u> Fram Mann CUK1919 Micronair MC773 Purflux Tecnocar Fiaam</p>
	<p>I Il filtro è posizionato nell'abitacolo dietro il vano portaoggetti</p> <p>GB The filter is located in the passenger compartment behind the glove compartment</p> <p>F Le filtre est situé dans l'habitacle derrière la boîte à gants</p> <p>D Der filter befindet sich im Fahrgastraum hinter dem Handschuhfach</p> <p>E El filtro se encuentra en el habitáculo detrás de la guantera</p>				

<p>--- Rav 4 IV ---</p>	12/12 ->	*	*	<p>CK 1919 215 x 193 x 29</p> <p><u>O/E numbers</u> Toyota 8713902020 - 871390D010</p> <p><u>Cross References</u> Fram CF10285/CF10322 Mann CU1919 Micronair MP273 Purflux AH256 Tecnocar E467 Fiaam PC8186</p>	<p>CK 1919-C 215 x 193 x 29</p> <p><u>O/E numbers</u> Toyota 8713950060 - 8713952020</p> <p><u>Cross References</u> Fram Mann CUK1919 Micronair MC773 Purflux Tecnocar Fiaam</p>
	<p>I Il filtro è posizionato nell'abitacolo dietro il vano portaoggetti</p> <p>GB The filter is located in the passenger compartment behind the glove compartment</p> <p>F Le filtre est situé dans l'habitacle derrière la boîte à gants</p> <p>D Der filter befindet sich im Fahrgastraum hinter dem Handschuhfach</p> <p>E El filtro se encuentra en el habitáculo detrás de la guantera</p>				



<p>--- Tundra ---</p>	01/07 ->	*	*	<p>CK 1919 215 x 193 x 29</p> <p><u>O/E numbers</u> Toyota 8713902020 - 871390D010</p> <p><u>Cross References</u> Fram CF10285/CF10322 Mann CU1919 Micronair MP273 Purflux AH256 Tecnocar E467 Fiaam PC8186</p>	<p>CK 1919-C 215 x 193 x 29</p> <p><u>O/E numbers</u> Toyota 8713950060 - 8713952020</p> <p><u>Cross References</u> Fram Mann CUK1919 Micronair MC773 Purflux Tecnocar Fiaam</p>
	<p>I Il filtro è posizionato nell'abitacolo dietro il vano portaoggetti</p> <p>GB The filter is located in the passenger compartment behind the glove compartment</p> <p>F Le filtre est situé dans l'habitacle derrière la boîte à gants</p> <p>D Der filter befindet sich im Fahrgastraum hinter dem Handschuhfach</p> <p>E El filtro se encuentra en el habitáculo detrás de la guantera</p>				





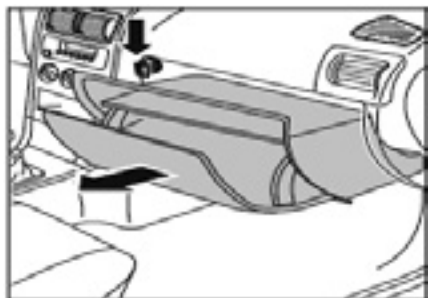

Anti-pollen

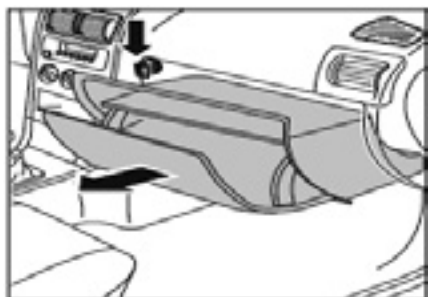

Activated carbon

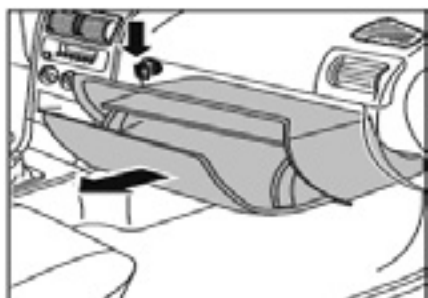

TOYOTA

<p>--- Urban Cruiser ---</p> 	04/09 ->	*	*	<p>CK 1919 215 x 193 x 29</p>  <p><u>O/E numbers</u> Toyota 8713902020 - 871390D010</p> <p><u>Cross References</u> Fram CF10285/CF10322 Mann CU1919 Micronair MP273 Purflux AH256 Tecocar E467 Fiaam PC8186</p>	<p>CK 1919-C 215 x 193 x 29</p>  <p><u>O/E numbers</u> Toyota 8713950060 - 8713952020</p> <p><u>Cross References</u> Fram Mann CUK1919 Micronair MC773 Purflux Tecocar Fiaam</p>
	<p>I Il filtro è posizionato nell'abitacolo dietro il vano portaoggetti</p> <p>GB The filter is located in the passenger compartment behind the glove compartment</p> <p>F Le filtre est situé dans l'habitacle derrière la boîte à gants</p> <p>D Der filter befindet sich im Fahrgastraum hinter dem Handschuhfach</p> <p>E El filtro se encuentra en el habitáculo detrás de la guantera</p>				

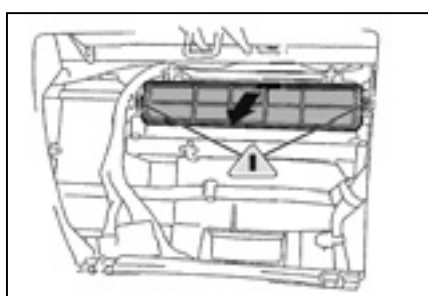
<p>--- Verso ---</p> 	04/09 ->	*	*	<p>CK 1919 215 x 193 x 29</p>  <p><u>O/E numbers</u> Toyota 8713902020 - 871390D010</p> <p><u>Cross References</u> Fram CF10285/CF10322 Mann CU1919 Micronair MP273 Purflux AH256 Tecocar E467 Fiaam PC8186</p>	<p>CK 1919-C 215 x 193 x 29</p>  <p><u>O/E numbers</u> Toyota 8713950060 - 8713952020</p> <p><u>Cross References</u> Fram Mann CUK1919 Micronair MC773 Purflux Tecocar Fiaam</p>
	<p>I Il filtro è posizionato nell'abitacolo dietro il vano portaoggetti</p> <p>GB The filter is located in the passenger compartment behind the glove compartment</p> <p>F Le filtre est situé dans l'habitacle derrière la boîte à gants</p> <p>D Der filter befindet sich im Fahrgastraum hinter dem Handschuhfach</p> <p>E El filtro se encuentra en el habitáculo detrás de la guantera</p>				

<p>--- Verso S ---</p> 	11/10 ->	*	*	<p>CK 1919 215 x 193 x 29</p>  <p><u>O/E numbers</u> Toyota 8713902020 - 871390D010</p> <p><u>Cross References</u> Fram CF10285/CF10322 Mann CU1919 Micronair MP273 Purflux AH256 Tecocar E467 Fiaam PC8186</p>	<p>CK 1919-C 215 x 193 x 29</p>  <p><u>O/E numbers</u> Toyota 8713950060 - 8713952020</p> <p><u>Cross References</u> Fram Mann CUK1919 Micronair MC773 Purflux Tecocar Fiaam</p>
	<p>I Il filtro è posizionato nell'abitacolo dietro il vano portaoggetti</p> <p>GB The filter is located in the passenger compartment behind the glove compartment</p> <p>F Le filtre est situé dans l'habitacle derrière la boîte à gants</p> <p>D Der filter befindet sich im Fahrgastraum hinter dem Handschuhfach</p> <p>E El filtro se encuentra en el habitáculo detrás de la guantera</p>				

<p>--- Yaris I / Yaris Verso Japanese vehicle manufacture</p> 	04/99 -> 09/05	*	*	<p>CK 9466 215 x 195 x 17</p>  <p><u>O/E numbers</u> Toyota 8856852010 / 8856852010-83</p> <p><u>Cross References</u> Fram CF9466 Mann CU1828 Micronair MP104 Purflux AH160 Tecocar E359 Fiaam PC8096</p>	<p>---</p>
	<p>I Il filtro è posizionato nell'abitacolo dietro il vano portaoggetti</p> <p>GB The filter is located in the passenger compartment behind the glove compartment</p> <p>F Le filtre est situé dans l'habitacle derrière la boîte à gants</p> <p>D Der filter befindet sich im Fahrgastraum hinter dem Handschuhfach</p> <p>E El filtro se encuentra en el habitáculo detrás de la guantera</p>				



<p>--- Yaris I / Yaris Verso French vehicle manufacture</p> 	04/99 -> 09/05	*	*	<p>CK 9846 215 x 215 x 17</p>  <p><u>O/E numbers</u> Toyota 8713947010 / 8713947010-83</p> <p><u>Cross References</u> Fram CF9846 Mann CU2131 Micronair MP105 Purflux AH210 Tecocar E414 Fiaam PC8144</p>	<p>---</p>
	<p>I Il filtro è posizionato nell'abitacolo dietro il vano portaoggetti</p> <p>GB The filter is located in the passenger compartment behind the glove compartment</p> <p>F Le filtre est situé dans l'habitacle derrière la boîte à gants</p> <p>D Der filter befindet sich im Fahrgastraum hinter dem Handschuhfach</p> <p>E El filtro se encuentra en el habitáculo detrás de la guantera</p>				





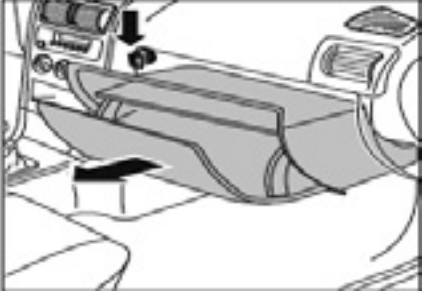

Anti-pollen

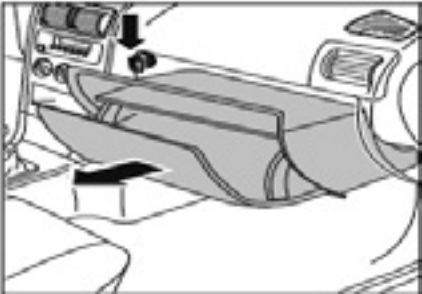

Activated carbon

TOYOTA

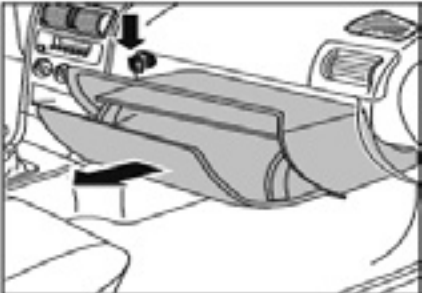
<p>--- Yaris I / Yaris Verso ---</p>  <ul style="list-style-type: none"> I Il filtro è posizionato nell'abitacolo dietro il vano portaoggetti GB The filter is located in the passenger compartment behind the glove compartment F Le filtre est situé dans l'habitacle derrière la boîte à gants D Der filter befindet sich im Fahrgastraum hinter dem Handschuhfach E El filtro se encuentra en el habitáculo detrás de la guantera 	<p>01/07 -> 12/08</p>	<p>*</p>	<p>*</p>	<p>CK 1919 215 x 193 x 29</p>  <p><u>O/E numbers</u> Toyota 8713902020 - 871390D010</p> <p><u>Cross References</u> Fram CF10285/CF10322 Mann CU1919 Micronair MP273 Purflux AH256 Tecocar E467 Fiaam PC8186</p>	<p>CK 1919-C 215 x 193 x 29</p>  <p><u>O/E numbers</u> Toyota 8713950060 - 8713952020</p> <p><u>Cross References</u> Fram Mann CUK1919 Micronair MC773 Purflux Tecocar Fiaam</p>
---	--------------------------	----------	----------	--	--

<p>--- Yaris II (XP9) ---</p>  <ul style="list-style-type: none"> I Il filtro è posizionato nell'abitacolo dietro il vano portaoggetti GB The filter is located in the passenger compartment behind the glove compartment F Le filtre est situé dans l'habitacle derrière la boîte à gants D Der filter befindet sich im Fahrgastraum hinter dem Handschuhfach E El filtro se encuentra en el habitáculo detrás de la guantera 	<p>01/06 -></p>	<p>*</p>	<p>*</p>	<p>CK 1919 215 x 193 x 29</p>  <p><u>O/E numbers</u> Toyota 8713902020 - 871390D010</p> <p><u>Cross References</u> Fram CF10285/CF10322 Mann CU1919 Micronair MP273 Purflux AH256 Tecocar E467 Fiaam PC8186</p>	<p>CK 1919-C 215 x 193 x 29</p>  <p><u>O/E numbers</u> Toyota 8713950060 - 8713952020</p> <p><u>Cross References</u> Fram Mann CUK1919 Micronair MC773 Purflux Tecocar Fiaam</p>
--	--------------------	----------	----------	--	--

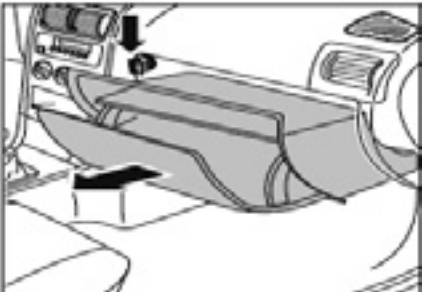
<p>--- Yaris III (XP13) ---</p>  <ul style="list-style-type: none"> I Il filtro è posizionato nell'abitacolo dietro il vano portaoggetti GB The filter is located in the passenger compartment behind the glove compartment F Le filtre est situé dans l'habitacle derrière la boîte à gants D Der filter befindet sich im Fahrgastraum hinter dem Handschuhfach E El filtro se encuentra en el habitáculo detrás de la guantera 	<p>09/11 -></p>	<p>*</p>	<p>*</p>	<p>CK 1919 215 x 193 x 29</p>  <p><u>O/E numbers</u> Toyota 8713902020 - 871390D010</p> <p><u>Cross References</u> Fram CF10285/CF10322 Mann CU1919 Micronair MP273 Purflux AH256 Tecocar E467 Fiaam PC8186</p>	<p>CK 1919-C 215 x 193 x 29</p>  <p><u>O/E numbers</u> Toyota 8713950060 - 8713952020</p> <p><u>Cross References</u> Fram Mann CUK1919 Micronair MC773 Purflux Tecocar Fiaam</p>
--	--------------------	----------	----------	--	--

<p>--- Yaris / Vios (ZSP9, NCP9) ---</p>  <ul style="list-style-type: none"> I Il filtro è posizionato nell'abitacolo dietro il vano portaoggetti GB The filter is located in the passenger compartment behind the glove compartment F Le filtre est situé dans l'habitacle derrière la boîte à gants D Der filter befindet sich im Fahrgastraum hinter dem Handschuhfach E El filtro se encuentra en el habitáculo detrás de la guantera 	<p>08/07 -></p>	<p>*</p>	<p>*</p>	<p>CK 1919 215 x 193 x 29</p>  <p><u>O/E numbers</u> Toyota 8713902020 - 871390D010</p> <p><u>Cross References</u> Fram CF10285/CF10322 Mann CU1919 Micronair MP273 Purflux AH256 Tecocar E467 Fiaam PC8186</p>	<p>CK 1919-C 215 x 193 x 29</p>  <p><u>O/E numbers</u> Toyota 8713950060 - 8713952020</p> <p><u>Cross References</u> Fram Mann CUK1919 Micronair MC773 Purflux Tecocar Fiaam</p>
---	--------------------	----------	----------	--	--



Anti-pollen

Activated carbon

VOLKSWAGEN

--- Amarok ---

01/10 -> * *

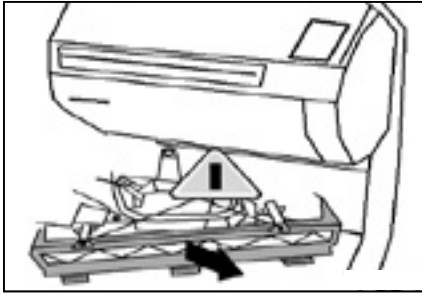

- I** Il filtro è posizionato nell'abitacolo sotto il vano portaoggetti
- II** The filter is located in the passenger compartment under the glove compartment
- F** Le filtre est situé dans l'habitacle en dessous de la boîte à gants
- D** Der filter befindet sich im Fahrgastraum unter dem Handschuhfach
- E** El filtro se encuentra en el habitáculo, bajo la guanterain de pasajerruimte

CK 9881

227 x 218 x 31



O/E numbers

V.A.G. 7H0819631

Cross References

Fram CF9881 Mann CU2842
Micronair MP141 Purflux AH209
Tecocar E413 Fiaam PC8158

CK 9881-C

227 x 218 x 31



O/E numbers

V.A.G. 7H0819631A

Cross References

Fram CFA9881 Mann CUK2842
Micronair MC641 Purflux AHC209
Tecocar EC413 Fiaam PCK8158

--- Beetle ---

10/11 -> *

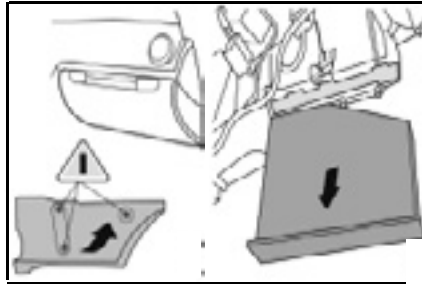

- I** Il filtro è posizionato nell'abitacolo sotto il vano portaoggetti
- II** The filter is located in the passenger compartment under the glove compartment
- F** Le filtre est situé dans l'habitacle en dessous de la boîte à gants
- D** Der filter befindet sich im Fahrgastraum unter dem Handschuhfach
- E** El filtro se encuentra en el habitáculo, bajo la guanterain de pasajerruimte

CK 9922

286/280 x 214 x 34/57



O/E numbers

V.A.G. 1K0819644 / 1K0819644A

Cross References

Fram CF9922 Mann CU2939
Micronair MP113 Purflux AH202
Tecocar E409 Fiaam PC8155

CK 9922-C

286/280 x 214 x 34/57



O/E numbers

V.A.G. 1K1819653 / 1K1819653A

Cross References

Fram CFA9921 Mann CUK2939
Micronair MC613 Purflux AHC202
Tecocar EC409 Fiaam PCK8155

--- Bora ---

11/98 -> * *

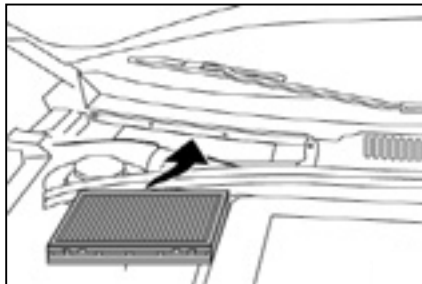

- I** Il filtro è posizionato nel vano motore sul lato passeggero
- II** The filter is located in the engine compartment on the passenger's side
- F** Le filtre est situé dans le compartiment moteur du côté passager
- D** Der filter befindet sich Motorraum auf der Beifahrerseite
- E** El filtro se encuentra en el compartimiento del motor, del lado del acompañante

CK 8869-C

282 x 206 x 29



O/E numbers

V.A.G. 1J0819644 / 1J0819644A

Cross References

Fram CFA8869 Mann CUK2862
Micronair MC592 Purflux AHC178
Tecocar EC381 Fiaam PCK8045

--- Bora II ---

12/04 ->

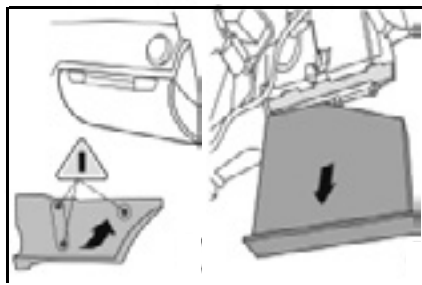

- I** Il filtro è posizionato nell'abitacolo sotto il vano portaoggetti
- II** The filter is located in the passenger compartment under the glove compartment
- F** Le filtre est situé dans l'habitacle en dessous de la boîte à gants
- D** Der filter befindet sich im Fahrgastraum unter dem Handschuhfach
- E** El filtro se encuentra en el habitáculo, bajo la guanterain de pasajerruimte

CK 9922

286/280 x 214 x 34/57



O/E numbers

V.A.G. 1K0819644 / 1K0819644A

Cross References

Fram CF9922 Mann CU2939
Micronair MP113 Purflux AH202
Tecocar E409 Fiaam PC8155

CK 9922-C

286/280 x 214 x 34/57



O/E numbers

V.A.G. 1K1819653 / 1K1819653A

Cross References

Fram CFA9921 Mann CUK2939
Micronair MC613 Purflux AHC202
Tecocar EC409 Fiaam PCK8155

--- Caddy II ---

11/95 -> 01/04 * *

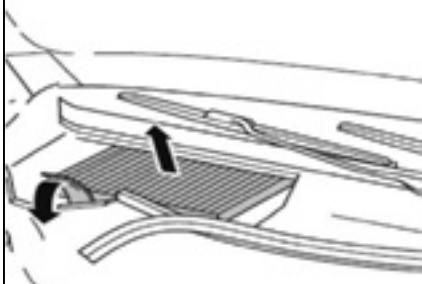

- I** Il filtro è posizionato nel vano motore al centro
- II** The filter is located in the engine compartment centrally
- F** Le filtre est situé dans le compartiment moteur au centre
- D** Der Filter befindet sich im Motorraum mitting
- E** El filtro se encuentra en el compartimiento del motor, en el centro

CK 5663

280 x 206 x 25



O/E numbers

V.A.G. 1H0819644A / 1H0819638A

Cross References

Fram CF5663 Mann CU2882
Micronair MP044 Purflux AH104
Tecocar E311 Fiaam PC8005

CK 5663-C

280 x 206 x 25



O/E numbers

V.A.G. 1H0091800 / 8L0091800

Cross References

Fram CFA8893 Mann CUK2882
Micronair MC544 Purflux AHC104
Tecocar Fiaam PCK8072



Anti-pollen

Activated carbon

VOLKSWAGEN

--- Caddy III ---

03/04 ->

*

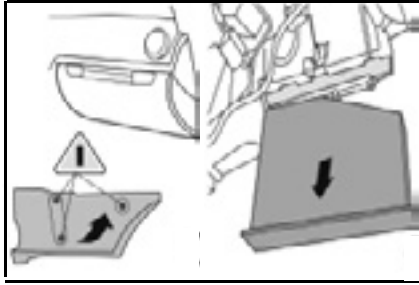

- I** Il filtro è posizionato nell'abitacolo sotto il vano portaoggetti
- GB** The filter is located in the passenger compartment under the glove compartment
- F** Le filtre est situé dans l'habitacle en dessous de la boîte à gants
- D** Der filter befindet sich im Fahrgastraum unter dem Handsuhfach
- E** El filtro se encuentra en el habitáculo, bajo la guantera de pasajerruimte

CK 9922

286/280 x 214 x 34/57



O/E numbers

V.A.G. 1K0819644 / 1K0819644A

Cross References

Fram CF9922 Mann CU2939
Micronair MP113 Purflux AH202
Tecocar E409 Fiaam PC8155

CK 9922-C

286/280 x 214 x 34/57



O/E numbers

V.A.G. 1K1819653 / 1K1819653A

Cross References

Fram CFA9921 Mann CUK2939
Micronair MC613 Purflux AHC202
Tecocar EC409 Fiaam PCK8155

--- Caddy IV ---

09/10 ->

*

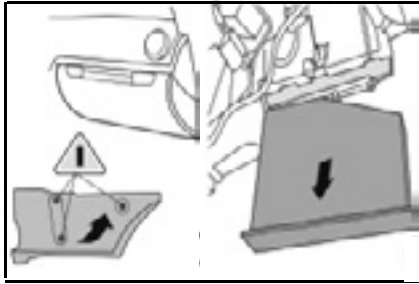

- I** Il filtro è posizionato nell'abitacolo sotto il vano portaoggetti
- GB** The filter is located in the passenger compartment under the glove compartment
- F** Le filtre est situé dans l'habitacle en dessous de la boîte à gants
- D** Der filter befindet sich im Fahrgastraum unter dem Handsuhfach
- E** El filtro se encuentra en el habitáculo, bajo la guantera de pasajerruimte

CK 9922

286/280 x 214 x 34/57



O/E numbers

V.A.G. 1K0819644 / 1K0819644A

Cross References

Fram CF9922 Mann CU2939
Micronair MP113 Purflux AH202
Tecocar E409 Fiaam PC8155

CK 9922-C

286/280 x 214 x 34/57



O/E numbers

V.A.G. 1K1819653 / 1K1819653A

Cross References

Fram CFA9921 Mann CUK2939
Micronair MC613 Purflux AHC202
Tecocar EC409 Fiaam PCK8155

--- Caravelle (T4) ---

07/90 -> 06/03

*

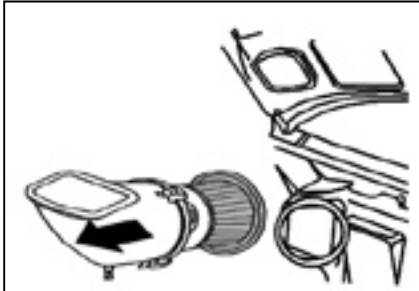

- I** Il filtro è posizionato nel vano motore sul lato passeggero
- GB** The filter is located in the engine compartment on the passenger's side
- F** Le filtre est situé dans le compartiment moteur du côté passager
- D** Der filter befindet sich Motorraum auf der Beifahrerseite
- E** El filtro se encuentra en el compartimiento del motor, del lado del acompañante

CK 9579

Ø 168 H 102



O/E numbers

V.A.G. 7038119989 / 7D0819989

Cross References

Fram CF9579 Mann CU1738
Micronair MP024 Purflux AH182
Tecocar E385 Fiaam PC8107

--- Caravelle (T5) ---

05/03 ->

*

*

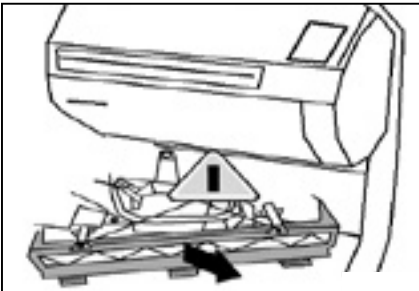

- I** Il filtro è posizionato nell'abitacolo sotto il vano portaoggetti
- GB** The filter is located in the passenger compartment under the glove compartment
- F** Le filtre est situé dans l'habitacle en dessous de la boîte à gants
- D** Der filter befindet sich im Fahrgastraum unter dem Handsuhfach
- E** El filtro se encuentra en el habitáculo, bajo la guantera de pasajerruimte

CK 9881

227 x 218 x 31



O/E numbers

V.A.G. 7H0819631

Cross References

Fram CF9881 Mann CU2842
Micronair MP141 Purflux AH209
Tecocar E413 Fiaam PC8158

CK 9881-C

227 x 218 x 31



O/E numbers

V.A.G. 7H0819631A

Cross References

Fram CFA9881 Mann CUK2842
Micronair MC641 Purflux AHC209
Tecocar EC413 Fiaam PCK8158

--- Caravelle (T6) ---

04/15 ->

*

*

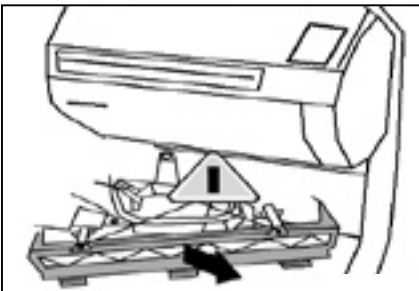

- I** Il filtro è posizionato nell'abitacolo sotto il vano portaoggetti
- GB** The filter is located in the passenger compartment under the glove compartment
- F** Le filtre est situé dans l'habitacle en dessous de la boîte à gants
- D** Der filter befindet sich im Fahrgastraum unter dem Handsuhfach
- E** El filtro se encuentra en el habitáculo, bajo la guantera de pasajerruimte

CK 9881

227 x 218 x 31



O/E numbers

V.A.G. 7H0819631

Cross References

Fram CF9881 Mann CU2842
Micronair MP141 Purflux AH209
Tecocar E413 Fiaam PC8158

CK 9881-C

227 x 218 x 31



O/E numbers

V.A.G. 7H0819631A

Cross References



Fram CFA9881 Mann CUK2842
Micronair MC641 Purflux AHC209
Tecocar EC413 Fiaam PCK8158







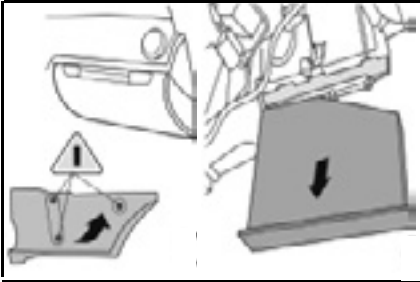

Anti-pollen

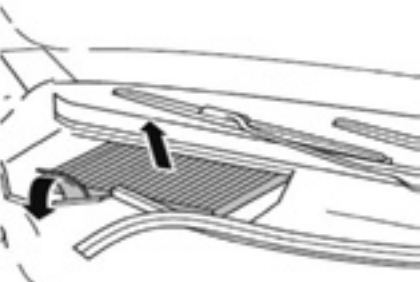

Activated carbon



VOLKSWAGEN

<p>--- CC (358) ---</p>  <p> <input type="checkbox"/> Il filtro è posizionato nell'abitacolo sotto il vano portaoggetti <input checked="" type="checkbox"/> The filter is located in the passenger compartment under the glove compartment <input type="checkbox"/> Le filtre est situé dans l'habitacle en dessous de la boîte à gants <input type="checkbox"/> Der filter befindet sich im Fahrgastraum unter dem Handshuhfach <input type="checkbox"/> El filtro se encuentra en el habitáculo, bajo la guanterain de pasajerruimte </p>	<p>11/11 -> * </p>	<p>CK 9922 286/280 x 214 x 34/57</p>  <p><u>O/E numbers</u> V.A.G. 1K0819644 / 1K0819644A</p> <p><u>Cross References</u> Fram CF9922 Mann CU2939 Micronair MP113 Purflux AH202 Tecocar E409 Fiaam PC8155</p>	<p>CK 9922-C 286/280 x 214 x 34/57</p>  <p><u>O/E numbers</u> V.A.G. 1K1819653 / 1K1819653A</p> <p><u>Cross References</u> Fram CFA9921 Mann CUK2939 Micronair MC613 Purflux AHC202 Tecocar EC409 Fiaam PCK8155</p>
---	---------------------------------	--	--

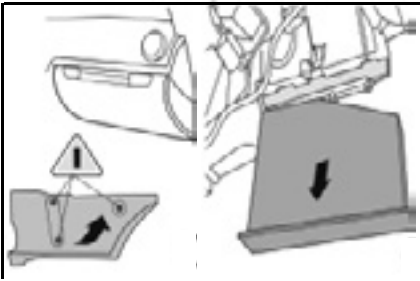
<p>--- Corrado ---</p>  <p> <input type="checkbox"/> Il filtro è posizionato nel vano motore al centro <input checked="" type="checkbox"/> The filter is located in the engine compartment centrally <input type="checkbox"/> Le filtre est situé dans le compartiment moteur au centre <input type="checkbox"/> Der Filter befindet sich im Motorraum mitting <input type="checkbox"/> El filtro se encuentra en el compartimiento del motor, en el centro </p>	<p>08/93 -> * *</p>	<p>CK 5663 280 x 206 x 25</p>  <p><u>O/E numbers</u> V.A.G. 1H0819644A / 1H0819638A</p> <p><u>Cross References</u> Fram CF5663 Mann CU2882 Micronair MP044 Purflux AH104 Tecocar E311 Fiaam PC8005</p>	<p>CK 5663-C 280 x 206 x 25</p>  <p><u>O/E numbers</u> V.A.G. 1H0091800 / 8L0091800</p> <p><u>Cross References</u> Fram CFA8893 Mann CUK2882 Micronair MC544 Purflux AHC104 Tecocar Fiaam PCK8072</p>
--	----------------------------------	--	--

<p>--- Crafter 30, 35, 50 (2E/2F) ---</p>  <p> <input type="checkbox"/> Il filtro è posizionato nel vano motore <input checked="" type="checkbox"/> The filter is located in the engine compartment <input type="checkbox"/> Le filtre est situé dans le compartiment moteur <input type="checkbox"/> Der Filter befindet sich im Motorraum <input type="checkbox"/> El filtro se encuentra en el compartimiento del motor </p>	<p>04/06 -> </p>	<p>CK 10436-10 351 x 233 x 35</p>  <p><u>O/E numbers</u> V.A.G. 2E0819638</p> <p><u>Cross References</u> Fram CF10436 Mann CU3569 Micronair MP177 Purflux AH268 Tecocar E470 Fiaam PC8199</p>	<p>CK 10436-10-C 351 x 233 x 35</p>  <p><u>O/E numbers</u> V.A.G. 2E0819638A</p> <p><u>Cross References</u> Fram CFA10436 Mann CUK3569 Micronair MC677 Purflux AHC268 Tecocar EC470 Fiaam PCK8199</p>
---	-------------------------------	---	--

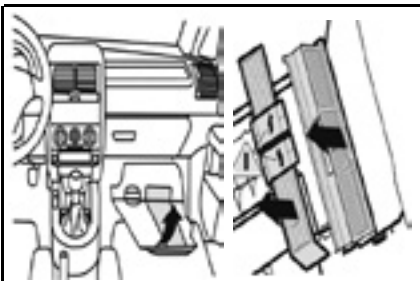
<p>--- Eos (1F7, 1F8) ---</p>  <p> <input type="checkbox"/> Il filtro è posizionato nell'abitacolo sotto il vano portaoggetti <input checked="" type="checkbox"/> The filter is located in the passenger compartment under the glove compartment <input type="checkbox"/> Le filtre est situé dans l'habitacle en dessous de la boîte à gants <input type="checkbox"/> Der filter befindet sich im Fahrgastraum unter dem Handshuhfach <input type="checkbox"/> El filtro se encuentra en el habitáculo, bajo la guanterain de pasajerruimte </p>	<p>05/06 -> * *</p>	<p>CK 9922 286/280 x 214 x 34/57</p>  <p><u>O/E numbers</u> V.A.G. 1K0819644 / 1K0819644A</p> <p><u>Cross References</u> Fram CF9922 Mann CU2939 Micronair MP113 Purflux AH202 Tecocar E409 Fiaam PC8155</p>	<p>CK 9922-C 286/280 x 214 x 34/57</p>  <p><u>O/E numbers</u> V.A.G. 1K1819653 / 1K1819653A</p> <p><u>Cross References</u> Fram CFA9921 Mann CUK2939 Micronair MC613 Purflux AHC202 Tecocar EC409 Fiaam PCK8155</p>
---	----------------------------------	--	--



<p>--- Fox ---</p>  <p> <input type="checkbox"/> Il filtro è posizionato nell'abitacolo sotto il vano portaoggetti <input checked="" type="checkbox"/> The filter is located in the passenger compartment under the glove compartment <input type="checkbox"/> Le filtre est situé dans l'habitacle en dessous de la boîte à gants <input type="checkbox"/> Der filter befindet sich im Fahrgastraum unter dem Handshuhfach <input type="checkbox"/> El filtro se encuentra en el habitáculo, bajo la guanterain de pasajerruimte </p>	<p>04/05 -> * *</p>	<p>CK 9323 251 x 215 x 32</p>  <p><u>O/E numbers</u> V.A.G. 6Q0820367</p> <p><u>Cross References</u> Fram CF9323 Mann CU2545 Micronair MP060 Purflux AH191 Tecocar E394 Fiaam PC8077</p>	<p>CK 9323-C 251 x 215 x 32</p>  <p><u>O/E numbers</u> V.A.G. 6Q0819653 / 6Q0820367-S</p> <p><u>Cross References</u> Fram CFA9404 Mann CUK2545 Micronair MC560 Purflux AHC191 Tecocar EC394 Fiaam PCK8092</p>
--	----------------------------------	--	--





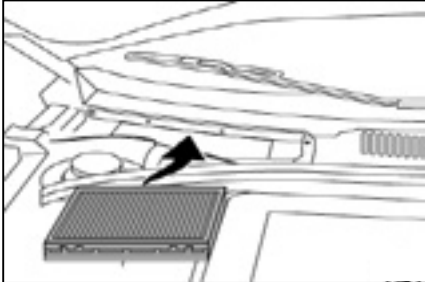

Anti-pollen

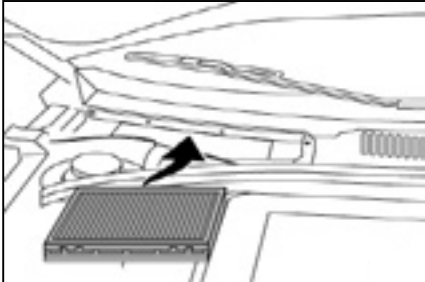

Activated carbon

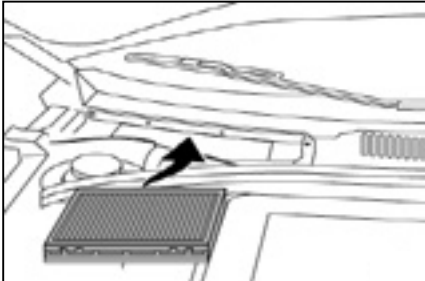

VOLKSWAGEN

<p>--- Golf ---</p> 	01/84 -> 08/91	*	*	<p>CK 5990</p> <p>191/181 x 180/170 x 39</p>  <p><u>O/E numbers</u> V.A.G. 191091700 / 191819638</p> <p><u>Cross References</u> Fram CF5990 Mann CU2038 Micronair..... Purflux AH135 Tecocar E334 Fiaam PC8034</p>	---
	<p>I Il filtro è posizionato nel vano motore sul lato passeggero</p> <p>GB The filter is located in the engine compartment on the passenger's side</p> <p>F Le filtre est situé dans le compartiment moteur du côté passager</p> <p>D Der filter befindet sich Motorraum auf der Beifahrerseite</p> <p>E El filtro se encuentra en el compartimiento del motor, del lado del acompañante</p>				

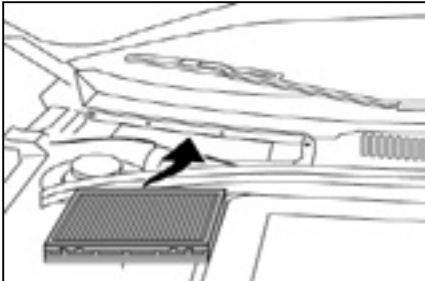
<p>--- Golf ---</p> 	09/91 ->	*	*	<p>CK 5474</p> <p>278/268 x 208 x 40</p>  <p><u>O/E numbers</u> V.A.G. 1H0819698</p> <p><u>Cross References</u> Fram CF5474 Mann..... Micronair..... Purflux..... Tecocar..... Fiaam PC8001</p>	---
	<p>I Il filtro è posizionato nel vano motore sul lato passeggero</p> <p>GB The filter is located in the engine compartment on the passenger's side</p> <p>F Le filtre est situé dans le compartiment moteur du côté passager</p> <p>D Der filter befindet sich Motorraum auf der Beifahrerseite</p> <p>E El filtro se encuentra en el compartimiento del motor, del lado del acompañante</p>				



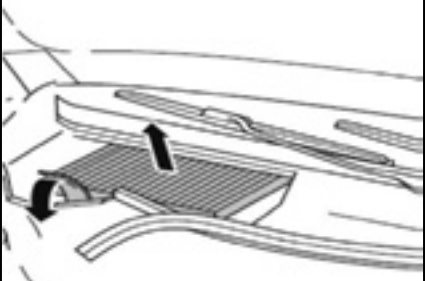





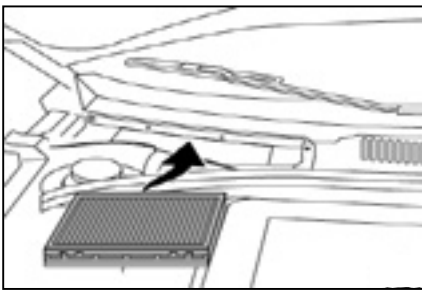

<p>--- Golf II ---</p> 	01/84 -> 08/91	*	*	<p>CK 5990</p> <p>191/181 x 180/170 x 39</p>  <p><u>O/E numbers</u> V.A.G. 191091700 / 191819638</p> <p><u>Cross References</u> Fram CF5990 Mann CU2038 Micronair..... Purflux AH135 Tecocar E334 Fiaam PC8034</p>	---
	<p>I Il filtro è posizionato nel vano motore sul lato passeggero</p> <p>GB The filter is located in the engine compartment on the passenger's side</p> <p>F Le filtre est situé dans le compartiment moteur du côté passager</p> <p>D Der filter befindet sich Motorraum auf der Beifahrerseite</p> <p>E El filtro se encuentra en el compartimiento del motor, del lado del acompañante</p>				

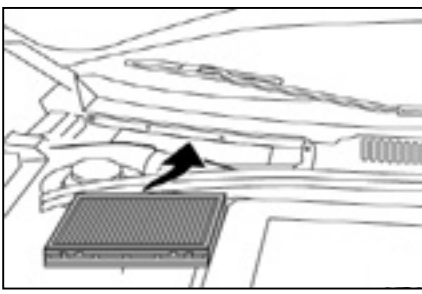
<p>--- Golf II ---</p> 	09/91 ->	*	*	<p>CK 5474</p> <p>278/268 x 208 x 40</p>  <p><u>O/E numbers</u> V.A.G. 1H0819698</p> <p><u>Cross References</u> Fram CF5474 Mann..... Micronair..... Purflux..... Tecocar..... Fiaam PC8001</p>	---
	<p>I Il filtro è posizionato nel vano motore sul lato passeggero</p> <p>GB The filter is located in the engine compartment on the passenger's side</p> <p>F Le filtre est situé dans le compartiment moteur du côté passager</p> <p>D Der filter befindet sich Motorraum auf der Beifahrerseite</p> <p>E El filtro se encuentra en el compartimiento del motor, del lado del acompañante</p>				

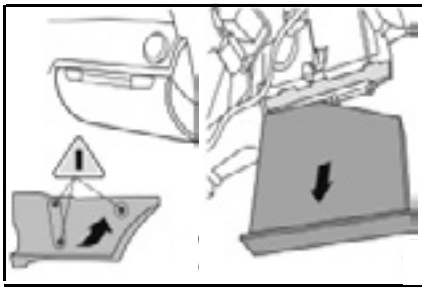
<p>--- Golf III ---</p> 	10/91 -> 07/93	*	*	<p>CK 5663</p> <p>280 x 206 x 25</p>  <p><u>O/E numbers</u> V.A.G. 1H0819644A / 1H0819638A</p> <p><u>Cross References</u> Fram CF5663 Mann CU2882 Micronair MP044 Purflux AH104 Tecocar E311 Fiaam PC8005</p>	<p>CK 5663-C</p> <p>280 x 206 x 25</p>  <p><u>O/E numbers</u> V.A.G. 1H0091800 / 8L0091800</p> <p><u>Cross References</u> Fram CFA8893 Mann CUK2882 Micronair MC544 Purflux AHC104 Tecocar Fiaam PCK8072</p>
	<p>I Il filtro è posizionato nel vano motore al centro</p> <p>GB The filter is located in the engine compartment centrally</p> <p>F Le filtre est situé dans le compartiment moteur au centre</p> <p>D Der Filter befindet sich im Motorraum mitting</p> <p>E El filtro se encuentra en el compartimiento del motor, en el centro</p>				

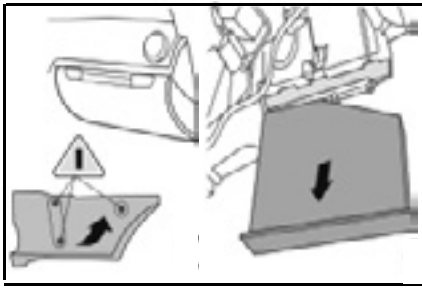

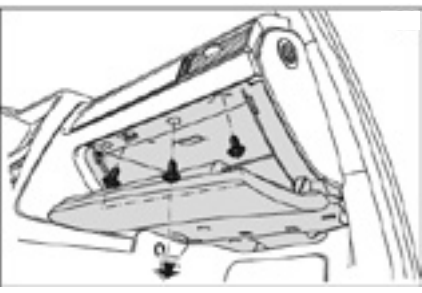
VOLKSWAGEN

<p>--- Golf III ---</p> 	<p>10/91 -> * *</p> <p>I Il filtro è posizionato nel vano motore sul lato passeggero GB The filter is located in the engine compartment on the passenger's side F Le filtre est situé dans le compartiment moteur du côté passager D Der filter befindet sich Motorraum auf der Beifahrerseite E El filtro se encuentra en el compartimiento del motor, del lado del acompañante</p>	<p>CK 5474 278/268 x 208 x 40</p>  <p><u>O/E numbers</u> V.A.G. 1H0819698 <u>Cross References</u> Fram CF5474 Mann..... Micronair..... Purflux..... TecnoCar..... Fiaam PC8001</p>	<p>---</p>
<p>--- Golf IV ---</p> 	<p>08/97 -> 09/03 * *</p> <p>I Il filtro è posizionato nel vano motore sul lato passeggero GB The filter is located in the engine compartment on the passenger's side F Le filtre est situé dans le compartiment moteur du côté passager D Der filter befindet sich Motorraum auf der Beifahrerseite E El filtro se encuentra en el compartimiento del motor, del lado del acompañante</p>	<p>---</p>	<p>CK 8869-C 282 x 206 x 29</p>  <p><u>O/E numbers</u> V.A.G. 1J0819644 / 1J0819644A <u>Cross References</u> Fram CFA8869 Mann CUK2862 Micronair MC592 Purflux AHC178 TecnoCar EC381 Fiaam PCK8045</p>
<p>--- Golf V ---</p> 	<p>10/03 -> 09/09 * *</p> <p>I Il filtro è posizionato nell'abitacolo sotto il vano portaoggetti GB The filter is located in the passenger compartment under the glove compartment F Le filtre est situé dans l'habitacle en dessous de la boîte à gants D Der filter befindet sich im Fahrgastraum unter dem Handschuhfach E El filtro se encuentra en el habitáculo, bajo la guantera de pasajerruimte</p>	<p>CK 9922 286/280 x 214 x 34/57</p>  <p><u>O/E numbers</u> V.A.G. 1K0819644 / 1K0819644A <u>Cross References</u> Fram CF9922 Mann CU2939 Micronair MP113 Purflux AH202 TecnoCar E409 Fiaam PC8155</p>	<p>CK 9922-C 286/280 x 214 x 34/57</p>  <p><u>O/E numbers</u> V.A.G. 1K1819653 / 1K1819653A <u>Cross References</u> Fram CFA9921 Mann CUK2939 Micronair MC613 Purflux AHC202 TecnoCar EC409 Fiaam PCK8155</p>
<p>--- Golf VI ---</p> 	<p>10/03 -> 09/09 * *</p> <p>I Il filtro è posizionato nell'abitacolo sotto il vano portaoggetti GB The filter is located in the passenger compartment under the glove compartment F Le filtre est situé dans l'habitacle en dessous de la boîte à gants D Der filter befindet sich im Fahrgastraum unter dem Handschuhfach E El filtro se encuentra en el habitáculo, bajo la guantera de pasajerruimte</p>	<p>CK 9922 286/280 x 214 x 34/57</p>  <p><u>O/E numbers</u> V.A.G. 1K0819644 / 1K0819644A <u>Cross References</u> Fram CF9922 Mann CU2939 Micronair MP113 Purflux AH202 TecnoCar E409 Fiaam PC8155</p>	<p>CK 9922-C 286/280 x 214 x 34/57</p>  <p><u>O/E numbers</u> V.A.G. 1K1819653 / 1K1819653A <u>Cross References</u> Fram CFA9921 Mann CUK2939 Micronair MC613 Purflux AHC202 TecnoCar EC409 Fiaam PCK8155</p>
<p>--- Golf VII ---</p> 	<p>11/12 -> * *</p> <p>I Il filtro è posizionato nell'abitacolo sotto il vano portaoggetti GB The filter is located in the passenger compartment under the glove compartment F Le filtre est situé dans l'habitacle en dessous de la boîte à gants D Der filter befindet sich im Fahrgastraum unter dem Handschuhfach E El filtro se encuentra en el habitáculo, bajo la guantera de pasajerruimte</p>	<p>CK 26009 253 x 234 x 30</p>  <p><u>O/E numbers</u> V.A.G. 5Q0819644 / 5Q0819644A <u>Cross References</u> Fram Mann CU26009 Micronair MP437 Purflux TecnoCar Fiaam</p>	<p>CK 26009-C 253 x 234 x 30</p>  <p><u>O/E numbers</u> V.A.G. 5Q0819653 <u>Cross References</u> Fram CFA11643 Mann CUK26009 Micronair MC937 Purflux AHC392 TecnoCar EC683 Fiaam PCK8361</p>



Anti-pollen

Activated carbon

VOLKSWAGEN

--- Golf Sportsvan ---

02/14 ->

*

*

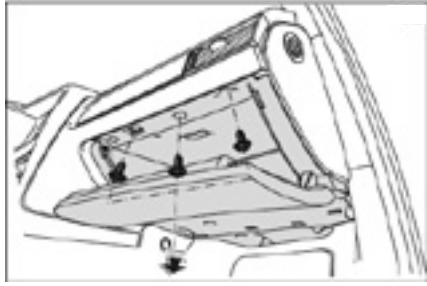

- Il filtro è posizionato nell'abitacolo sotto il vano portaoggetti
- The filter is located in the passenger compartment under the glove compartment
- Le filtre est situé dans l'habitacle en dessous de la boîte à gants
- Der filter befindet sich im Fahrgastraum unter dem Handsuhfach
- El filtro se encuentra en el habitáculo, bajo la guantera de pasajerruimte

CK 26009

253 x 234 x 30



O/E numbers

V.A.G. 5Q0819644 / 5Q0819644A

Cross References

Fram Mann CU26009
 Micronair MP437 Purflux
 Tecocar Fiaam

CK 26009-C

253 x 234 x 30



O/E numbers

V.A.G. 5Q0819653

Cross References

Fram CFA11643 Mann CUK26009
 Micronair MC937 Purflux AHC392
 Tecocar EC683 Fiaam PCK8361

--- Jetta II ---

08/83 -> 10/91

*

*

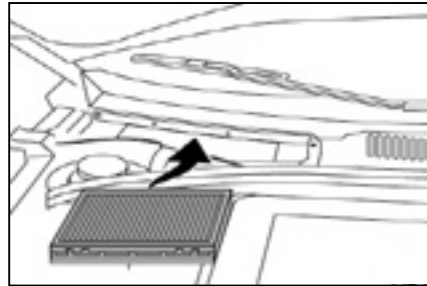

- Il filtro è posizionato nel vano motore sul lato passeggero
- The filter is located in the engine compartment on the passenger's side
- Le filtre est situé dans le compartiment moteur du côté passager
- Der filter befindet sich Motorraum auf der Beifahrerseite
- El filtro se encuentra en el compartimiento del motor, del lado del acompañante

CK 5990

191/181 x 180/170 x 39



O/E numbers

V.A.G. 191091700 / 191819638

Cross References

Fram CF5990 Mann CU2038
 Micronair..... Purflux AH135
 Tecocar E334 Fiaam PC8034

--- Jetta III ---

07/06 -> 10/10

*

*

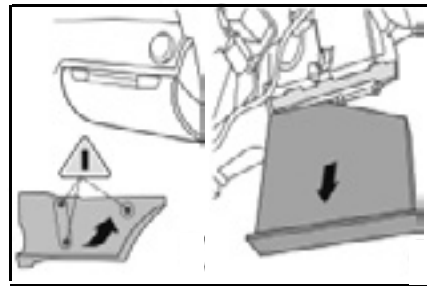

- Il filtro è posizionato nell'abitacolo sotto il vano portaoggetti
- The filter is located in the passenger compartment under the glove compartment
- Le filtre est situé dans l'habitacle en dessous de la boîte à gants
- Der filter befindet sich im Fahrgastraum unter dem Handsuhfach
- El filtro se encuentra en el habitáculo, bajo la guantera de pasajerruimte

CK 992

286/280 x 214 x 34/57



O/E numbers

V.A.G. 1K0819644 / 1K0819644A

Cross References

Fram CF9922 Mann CU2939
 Micronair MP113 Purflux AH202
 Tecocar E409 Fiaam PC8155

CK 992-C

286/280 x 214 x 34/57



O/E numbers

V.A.G. 1K1819653 / 1K1819653A

Cross References

Fram CFA9921 Mann CUK2939
 Micronair MC613 Purflux AHC202
 Tecocar EC409 Fiaam PCK8155

--- Jetta IV ---

01/11 ->

*

*

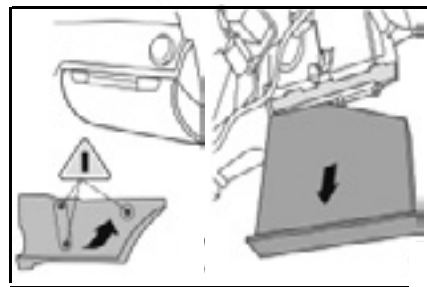

- Il filtro è posizionato nell'abitacolo sotto il vano portaoggetti
- The filter is located in the passenger compartment under the glove compartment
- Le filtre est situé dans l'habitacle en dessous de la boîte à gants
- Der filter befindet sich im Fahrgastraum unter dem Handsuhfach
- El filtro se encuentra en el habitáculo, bajo la guantera de pasajerruimte

CK 992

286/280 x 214 x 34/57



O/E numbers

V.A.G. 1K0819644 / 1K0819644A

Cross References

Fram CF9922 Mann CU2939
 Micronair MP113 Purflux AH202
 Tecocar E409 Fiaam PC8155

CK 992-C

286/280 x 214 x 34/57



O/E numbers

V.A.G. 1K1819653 / 1K1819653A

Cross References

Fram CFA9921 Mann CUK2939
 Micronair MC613 Purflux AHC202
 Tecocar EC409 Fiaam PCK8155

--- LT 28, 35, 46 ---

05/96 -> 05/06

*

*

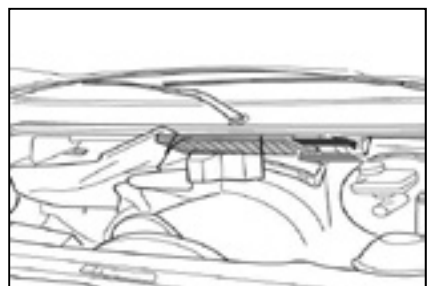

- Il filtro è posizionato nel vano motore
- The filter is located in the engine compartment
- Le filtre est situé dans le compartiment moteur
- Der Filter befindet sich im Motorraum
- El filtro se encuentra en el compartimiento del motor

CK 9051

375/365 x 164 x 27,5



O/E numbers

V.A.G. 2D0819638 / 2D0819638A

Cross References

Fram CF9051 Mann CU3858
 Micronair MP020 Purflux AH158
 Tecocar E376 Fiaam PC8058

CK 9051-C

375/365 x 164 x 27,5



O/E numbers

V.A.G.

Cross References

Fram..... Mann CUK3858
 Micronair MC520 Purflux.....
 Tecocar..... Fiaam.....



Anno di fabbricazione / Year of construction



Con climatizzatore / With air-conditioning / Avec climatisation



Senza climatizzatore / Without air-conditioning / Sans climatisation

Anné de fabrication / Baujahr / Año de fabricaciór

Mit Klimaanlage / Con instalación de aire acondicionado









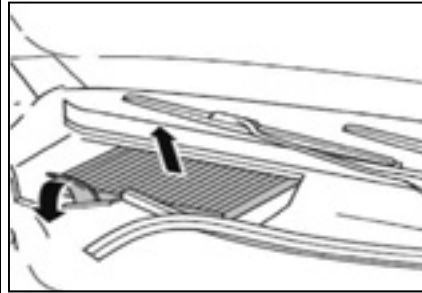

Ohne Klimaanlage / Sin instalación de aire acondicionado

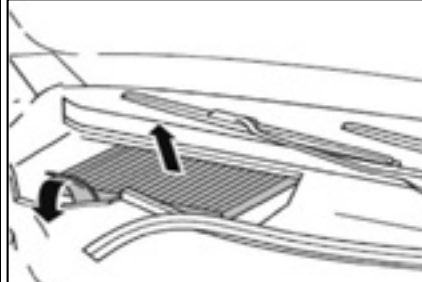

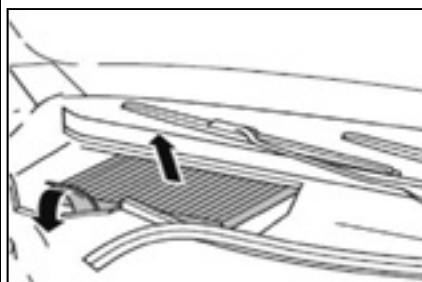
Anti-pollen

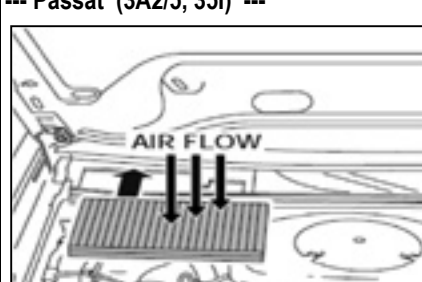
Activated carbon

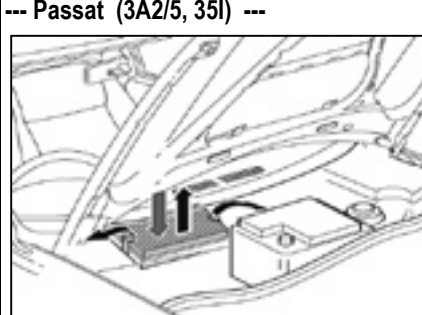
VOLKSWAGEN

<p>--- Lupo ---</p> 	<p>10/98 -> 07/05</p> <p>* *</p> <p> I Il filtro è posizionato nel vano motore sul lato passeggero II The filter is located in the engine compartment on the passenger's side F Le filtre est situé dans le compartiment moteur du côté passager D Der filter befindet sich Motorraum auf der Beifahrerseite E El filtro se encuentra en el compartimiento del motor, del lado del acompañante </p>	<p>CK 5663</p> <p>280 x 206 x 25</p>  <p><u>O/E numbers</u> V.A.G. 1H0819644A / 1H0819638A</p> <p><u>Cross References</u> Fram CF5663 Mann CU2882 Micronair MP044 Purflux AH104 Tecnocar E311 Fiaam PC8005</p>	<p>CK 5663-C</p> <p>280 x 206 x 25</p>  <p><u>O/E numbers</u> V.A.G. 1H0091800 / 8L0091800</p> <p><u>Cross References</u> Fram CFA8893 Mann CUK2882 Micronair MC544 Purflux..... Tecnocar Fiaam PCK8072</p>
<p>--- Lupo ---</p> 	<p>10/98 -> 07/05</p> <p>* *</p> <p> I Il filtro è posizionato nel vano motore sul lato passeggero II The filter is located in the engine compartment on the passenger's side F Le filtre est situé dans le compartiment moteur du côté passager D Der filter befindet sich Motorraum auf der Beifahrerseite E El filtro se encuentra en el compartimiento del motor, del lado del acompañante </p>	<p>---</p>	<p>CK 8869-C</p> <p>282 x 206 x 29</p> <p><i>only together with adapter frame 1J0819648</i></p>  <p><u>O/E numbers</u> V.A.G. 1J0819644 / 1J0819644A</p> <p><u>Cross References</u> Fram CFA8869 Mann CUK2862 Micronair MC592 Purflux AHC178 Tecnocar EC381 Fiaam PCK8045</p>
<p>--- New Beetle ---</p> 	<p>06/98 -></p> <p>* *</p> <p> I Il filtro è posizionato nel vano motore sul lato passeggero II The filter is located in the engine compartment on the passenger's side F Le filtre est situé dans le compartiment moteur du côté passager D Der filter befindet sich Motorraum auf der Beifahrerseite E El filtro se encuentra en el compartimiento del motor, del lado del acompañante </p>	<p>---</p>	<p>CK 8869-C</p> <p>282 x 206 x 29</p>  <p><u>O/E numbers</u> V.A.G. 1J0819644 / 1J0819644A</p> <p><u>Cross References</u> Fram CFA8869 Mann CUK2862 Micronair MC592 Purflux AHC178 Tecnocar EC381 Fiaam PCK8045</p>
<p>--- Passat (3A2/5, 35l) ---</p> 	<p>08/94 -> 05/97</p> <p>* *</p> <p> I Il filtro è posizionato nel vano motore sul lato passeggero II The filter is located in the engine compartment on the passenger's side F Le filtre est situé dans le compartiment moteur du côté passager D Der filter befindet sich Motorraum auf der Beifahrerseite E El filtro se encuentra en el compartimiento del motor, del lado del acompañante </p>	<p>CK 9414</p> <p>262 x 191 x 29,5</p>  <p><u>O/E numbers</u> V.A.G. 3A0819644 / 3A0819638</p> <p><u>Cross References</u> Fram CF9414 Mann CU2672 Micronair MP031 Purflux AH125 Tecnocar E326/E335 Fiaam PC8094</p>	<p>CK 9414-C</p> <p>262 x 191 x 29,5</p>  <p><u>O/E numbers</u> V.A.G. 3A0091800</p> <p><u>Cross References</u> Fram..... Mann CUK2672 Micronair MC589 Purflux AHC136 Tecnocar..... Fiaam.....</p>
<p>--- Passat (3A2/5, 35l) ---</p> 	<p>10/96 -> 09/00</p> <p>* *</p> <p> I Il filtro è posizionato nel vano motore sul lato passeggero sotto il coperchio della vaschetta del radiatore II The filter is located in the engine compartment on the passenger's side under the radiator tank cover F Le filtre est situé dans le compartiment moteur du côté passager en dessous du cache du réservoir à eau D Der filter befindet sich Motorraum auf der Beifahrerseite unter der Wasserkastenabdeckung E El filtro se encuentra en el compartimiento del motor, lado del acompañante, bajo la cubierta del depósito del agua </p>	<p>CK 5662</p> <p>387 x 151 x 26</p>  <p><u>O/E numbers</u> V.A.G. 8A819439 / 893091700</p> <p><u>Cross References</u> Fram CF5662 Mann CU3955 Micronair MP011 Purflux AH119 Tecnocar E313 Fiaam PC8004</p>	<p>CK 5662-C</p> <p>387 x 151 x 26</p>  <p><u>O/E numbers</u> V.A.G. 3B0091800 / 8D0091800</p> <p><u>Cross References</u> Fram CFA8882 Mann CUK3955 Micronair MC511 Purflux AHC119 Tecnocar..... Fiaam PCK8071</p>



Anti-pollen

Activated carbon

VOLKSWAGEN

--- Passat (3B3/3B6) ---

10/00 -> 09/05

*

*

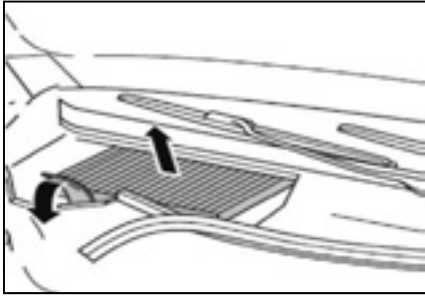

- I** Il filtro è posizionato nel vano motore sul lato passeggero
- II** The filter is located in the engine compartment on the passenger's side
- F** Le filtre est situé dans le compartiment moteur du côté passager
- D** Der filter befindet sich Motorraum auf der Beifahrerseite
- E** El filtro se encuentra en el compartimiento del motor, del lado del acompañante

CK 5663

280 x 206 x 25



O/E numbers

V.A.G. 1H0819644A / 1H0819638A

Cross References

Fram CF5663 Mann CU2882
 Micronair MP044 Purflux AH104
 Tecocar E311 Fiaam PC8005

CK 5663-C

280 x 206 x 25



O/E numbers

V.A.G. 1H0091800 / 8L0091800

Cross References

Fram CFA8893 Mann CUK2882
 Micronair MC544 Purflux AHC104
 Tecocar Fiaam PCK8072

--- Passat (3B2/5, 3B5) ---

01/96 -> 12/00

*

*

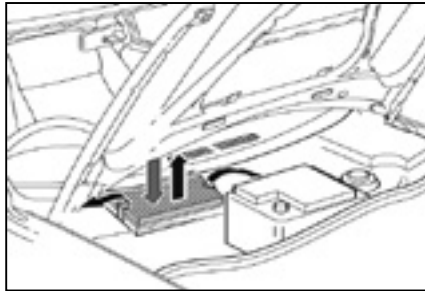

- I** Il filtro è posizionato nel vano motore sul lato passeggero sotto il coperchio della vaschetta del radiatore
- II** The filter is located in the engine compartment on the passenger's side under the radiator tank cover
- F** Le filtre est situé dans le compartiment moteur du côté passager en dessous du cache du réservoir à eau
- D** Der filter befindet sich Motorraum auf der Beifahrerseite unter der Wasserkastenabdeckung
- E** El filtro se encuentra en el compartimiento del motor, lado del acompañante, bajo la cubierta del depósito del agua

CK 5662

387 x 151 x 26



O/E numbers

V.A.G. 8A819439 / 893091700

Cross References

Fram CF5662 Mann CU3955
 Micronair MP011 Purflux AH119
 Tecocar E313 Fiaam PC8004

CK 5662-C

387 x 151 x 26



O/E numbers

V.A.G. 3B0091800 / 8D0091800

Cross References

Fram CFA8882 Mann CUK3955
 Micronair MC511 Purflux AHC119
 Tecocar Fiaam PCK8071

--- Passat (3B3, 3B6) ---

11/00 -> 09/05

*

*

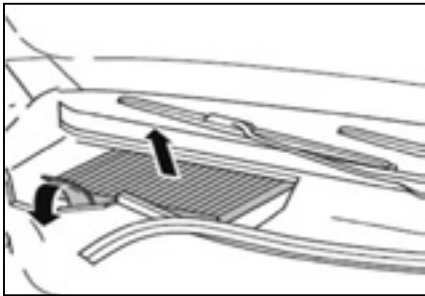

- I** Il filtro è posizionato nel vano motore sul lato passeggero
- II** The filter is located in the engine compartment on the passenger's side
- F** Le filtre est situé dans le compartiment moteur du côté passager
- D** Der filter befindet sich Motorraum auf der Beifahrerseite
- E** El filtro se encuentra en el compartimiento del motor, del lado del acompañante

CK 5663

280 x 206 x 25



O/E numbers

V.A.G. 1H0819644A / 1H0819638A

Cross References

Fram CF5663 Mann CU2882
 Micronair MP044 Purflux AH104
 Tecocar E311 Fiaam PC8005

CK 5663-C

280 x 206 x 25



O/E numbers

V.A.G. 1H0091800 / 8L0091800

Cross References

Fram CFA8893 Mann CUK2882
 Micronair MC544 Purflux AHC104
 Tecocar Fiaam PCK8072

--- Passat (362,365)/Passat CC (357) ---

11/10 ->

*

*

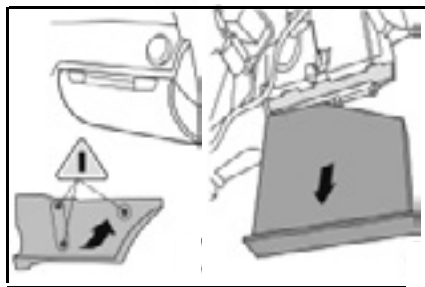

- I** Il filtro è posizionato nell'abitacolo sotto il vano portaoggetti
- II** The filter is located in the passenger compartment under the glove compartment
- F** Le filtre est situé dans l'habitacle en dessous de la boîte à gants
- D** Der filter befindet sich im Fahrgastraum unter dem Handschuhfach
- E** El filtro se encuentra en el habitáculo, bajo la guanterain de pasajerruimte

CK 9922

286/280 x 214 x 34/57



O/E numbers

V.A.G. 1K0819644 / 1K0819644A

Cross References

Fram CF9922 Mann CU2939
 Micronair MP113 Purflux AH202
 Tecocar E409 Fiaam PC8155

CK 9922-C

286/280 x 214 x 34/57



O/E numbers

V.A.G. 1K1819653 / 1K1819653A

Cross References

Fram CFA9921 Mann CUK2939
 Micronair MC613 Purflux AHC202
 Tecocar EC409 Fiaam PCK8155

--- Passat (3C2,3C5)/Passat CC (357) ---

03/05 ->

*

*

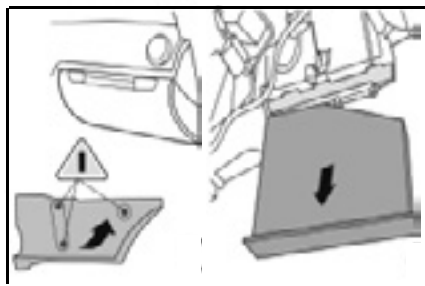

- I** Il filtro è posizionato nell'abitacolo sotto il vano portaoggetti
- II** The filter is located in the passenger compartment under the glove compartment
- F** Le filtre est situé dans l'habitacle en dessous de la boîte à gants
- D** Der filter befindet sich im Fahrgastraum unter dem Handschuhfach
- E** El filtro se encuentra en el habitáculo, bajo la guanterain de pasajerruimte

CK 9922

286/280 x 214 x 34/57



O/E numbers

V.A.G. 1K0819644 / 1K0819644A

Cross References

Fram CF9922 Mann CU2939
 Micronair MP113 Purflux AH202
 Tecocar E409 Fiaam PC8155

CK 9922-C

286/280 x 214 x 34/57



O/E numbers

V.A.G. 1K1819653 / 1K1819653A

Cross References



Fram CFA9921 Mann CUK2939
 Micronair MC613 Purflux AHC202
 Tecocar EC409 Fiaam PCK8155





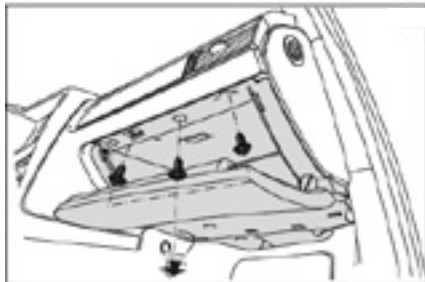

Anti-pollen

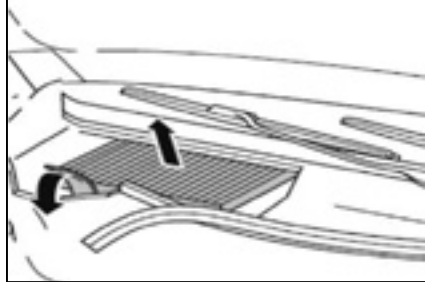

Activated carbon

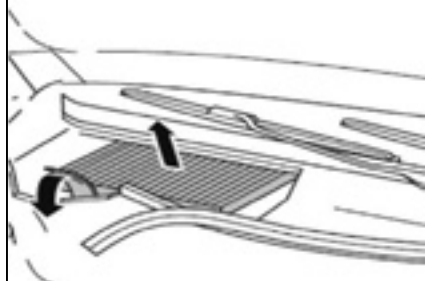

VOLKSWAGEN

<p>--- Passat (3G2,3G5) ---</p> 	11/14 ->	*	*	<p>CK 26009</p> <p>253 x 234 x 30</p>  <p><u>O/E numbers</u> V.A.G. 5Q0819644 / 5Q0819644A</p> <p><u>Cross References</u> Fram Mann CU26009 Micronair MP437 Purflux Tecocar Fiaam</p>	<p>CK 26009-C</p> <p>253 x 234 x 30</p>  <p><u>O/E numbers</u> V.A.G. 5Q0819653</p> <p><u>Cross References</u> Fram CFA11643 Mann CUK26009 Micronair MC937 Purflux AHC392 Tecocar EC683 Fiaam PCK8361</p>
	<p>I Il filtro è posizionato nell'abitacolo sotto il vano portaoggetti</p> <p>GB The filter is located in the passenger compartment under the glove compartment</p> <p>F Le filtre est situé dans l'habitacle en dessous de la boîte à gants</p> <p>D Der filter befindet sich im Fahrgastraum unter dem Handsuhfach</p> <p>E El filtro se encuentra en el habitáculo, bajo la guantera de pasajerruimte</p>				

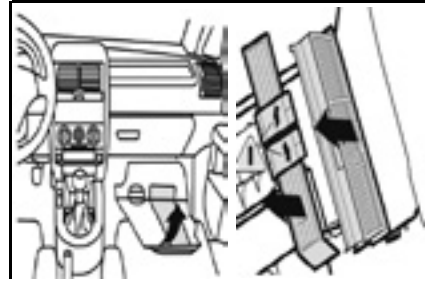
<p>--- Polo III ---</p> 	11/94 -> 09/01	*	*	<p>CK 5663</p> <p>280 x 206 x 25</p>  <p><u>O/E numbers</u> V.A.G. 1H0819644A / 1H0819638A</p> <p><u>Cross References</u> Fram CF5663 Mann CU2882 Micronair MP044 Purflux AH104 Tecocar E311 Fiaam PC8005</p>	<p>CK 5663-C</p> <p>280 x 206 x 25</p>  <p><u>O/E numbers</u> V.A.G. 1H0091800 / 8L0091800</p> <p><u>Cross References</u> Fram CFA8893 Mann CUK2882 Micronair MC544 Purflux AHC104 Tecocar Fiaam PCK8072</p>
	<p>I Il filtro è posizionato nel vano motore sul lato passeggero</p> <p>GB The filter is located in the engine compartment on the passenger's side</p> <p>F Le filtre est situé dans le compartiment moteur du côté passager</p> <p>D Der filter befindet sich Motorraum auf der Beifahrerseite</p> <p>E El filtro se encuentra en el compartimiento del motor, del lado del acompañante</p>				

<p>--- Polo III ---</p> 	11/94 -> 09/01	*	*	<p>---</p>	<p>CK 8869-C</p> <p>282 x 206 x 29</p> <p><i>only together with adapter frame 1J0819648</i></p>  <p><u>O/E numbers</u> V.A.G. 1J0819644 / 1J0819644A</p> <p><u>Cross References</u> Fram CFA8869 Mann CUK2862 Micronair MC592 Purflux AHC178 Tecocar EC381 Fiaam PCK8045</p>
	<p>I Il filtro è posizionato nel vano motore sul lato passeggero</p> <p>GB The filter is located in the engine compartment on the passenger's side</p> <p>F Le filtre est situé dans le compartiment moteur du côté passager</p> <p>D Der filter befindet sich Motorraum auf der Beifahrerseite</p> <p>E El filtro se encuentra en el compartimiento del motor, del lado del acompañante</p>				

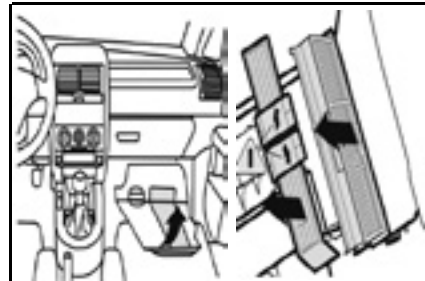
<p>--- Polo IV ---</p> 	10/01 ->	*	*	<p>CK 9323</p> <p>251 x 215 x 32</p>  <p><u>O/E numbers</u> V.A.G. 6Q0820367</p> <p><u>Cross References</u> Fram CF9323 Mann CU2545 Micronair MP060 Purflux AH191 Tecocar E394 Fiaam PC8077</p>	<p>CK 9323-C</p> <p>251 x 215 x 32</p>  <p><u>O/E numbers</u> V.A.G. 6Q0819653 / 6Q0820367-S</p> <p><u>Cross References</u> Fram CFA9404 Mann CUK2545 Micronair MC560 Purflux AHC191 Tecocar EC394 Fiaam PCK8092</p>
	<p>I Il filtro è posizionato nell'abitacolo sotto il vano portaoggetti</p> <p>GB The filter is located in the passenger compartment under the glove compartment</p> <p>F Le filtre est situé dans l'habitacle en dessous de la boîte à gants</p> <p>D Der filter befindet sich im Fahrgastraum unter dem Handsuhfach</p> <p>E El filtro se encuentra en el habitáculo, bajo la guantera de pasajerruimte</p>				

<p>--- Polo V ---</p> 	06/09 -> 05/10	*	*	<p>CK 9323</p> <p>251 x 215 x 32</p>  <p><u>O/E numbers</u> V.A.G. 6Q0820367</p> <p><u>Cross References</u> Fram CF9323 Mann CU2545 Micronair MP060 Purflux AH191 Tecocar E394 Fiaam PC8077</p>	<p>CK 9323-C</p> <p>251 x 215 x 32</p>  <p><u>O/E numbers</u> V.A.G. 6Q0819653 / 6Q0820367-S</p> <p><u>Cross References</u> Fram CFA9404 Mann CUK2545 Micronair MC560 Purflux AHC191 Tecocar EC394 Fiaam PCK8092</p>
	<p>I Il filtro è posizionato nell'abitacolo sotto il vano portaoggetti</p> <p>GB The filter is located in the passenger compartment under the glove compartment</p> <p>F Le filtre est situé dans l'habitacle en dessous de la boîte à gants</p> <p>D Der filter befindet sich im Fahrgastraum unter dem Handsuhfach</p> <p>E El filtro se encuentra en el habitáculo, bajo la guantera de pasajerruimte</p>				



Anti-pollen

Activated carbon

VOLKSWAGEN

<p>--- Polo V ---</p>	06/10 ->	*	*	<p>CK 26010 252,5 x 223 x 36</p> <p><u>O/E numbers</u> V.A.G. 6R0820367</p> <p><u>Cross References</u> Fram CF9323 Mann CU26010 Micronair MP400 Purflux AH191 Tecocar E394 Fiaam</p>	<p>CK 26010-C 252,5 x 223 x 36</p> <p><u>O/E numbers</u> V.A.G. 6R0819653</p> <p><u>Cross References</u> Fram CFA9404 Mann CUK26010 Micronair MC900 Purflux AHC191 Tecocar EC394 Fiaam PCK8092</p>
	<p>I Il filtro è posizionato nell'abitacolo dietro il vano portaoggetti</p> <p>GB The filter is located in the passenger compartment behind the glove compartment</p> <p>F Le filtre est situé dans l'habitacle derrière la boîte à gants</p> <p>D Der filter befindet sich im Fahrgastraum hinter dem Handsuhfach</p> <p>E El filtro se encuentra en el habitáculo detrás de la guantera</p>				

<p>--- Polo V Stufenheck/Sedan (61) ---</p>	06/10 ->	*	*	<p>CK 9323 251 x 215 x 32 for mounting with plastic frame</p> <p><u>O/E numbers</u> V.A.G. 6Q0820367</p> <p><u>Cross References</u> Fram CF9323 Mann CU2545 Micronair MP060 Purflux AH191 Tecocar E394 Fiaam PC8077</p>	<p>CK 9323-C 251 x 215 x 32 for mounting with plastic frame</p> <p><u>O/E numbers</u> V.A.G. 6Q0819653 / 6Q0820367-S</p> <p><u>Cross References</u> Fram CFA9404 Mann CUK2545 Micronair MC560 Purflux AHC191 Tecocar EC394 Fiaam PCK8092</p>
	<p>I Il filtro è posizionato nell'abitacolo sotto il vano portaoggetti</p> <p>GB The filter is located in the passenger compartment under the glove compartment</p> <p>F Le filtre est situé dans l'habitacle en dessous de la boîte à gants</p> <p>D Der filter befindet sich im Fahrgastraum unter dem Handsuhfach</p> <p>E El filtro se encuentra en el habitáculo, bajo la guantera de pasajerruimte</p>				

<p>--- Polo V Stufenheck/Sedan (61) ---</p>	06/10 ->	*	*	<p>CK 26010 252,5 x 223 x 36 for mounting without plastic frame</p> <p><u>O/E numbers</u> V.A.G. 6R0820367</p> <p><u>Cross References</u> Fram CF9323 Mann CU26010 Micronair MP400 Purflux AH191 Tecocar E394 Fiaam</p>	<p>CK 26010-C 252,5 x 223 x 36 for mounting without plastic frame</p> <p><u>O/E numbers</u> V.A.G. 6R0819653</p> <p><u>Cross References</u> Fram CFA9404 Mann CUK26010 Micronair MC900 Purflux AHC191 Tecocar EC394 Fiaam PCK8092</p>
	<p>I Il filtro è posizionato nell'abitacolo dietro il vano portaoggetti</p> <p>GB The filter is located in the passenger compartment behind the glove compartment</p> <p>F Le filtre est situé dans l'habitacle derrière la boîte à gants</p> <p>D Der filter befindet sich im Fahrgastraum hinter dem Handsuhfach</p> <p>E El filtro se encuentra en el habitáculo detrás de la guantera</p>				

<p>--- Polo VI ---</p>	03/14 ->	*	*	<p>CK 9323 251 x 215 x 32 for mounting with plastic frame</p> <p><u>O/E numbers</u> V.A.G. 6Q0820367</p> <p><u>Cross References</u> Fram CF9323 Mann CU2545 Micronair MP060 Purflux AH191 Tecocar E394 Fiaam PC8077</p>	<p>CK 9323-C 251 x 215 x 32 for mounting with plastic frame</p> <p><u>O/E numbers</u> V.A.G. 6Q0819653 / 6Q0820367-S</p> <p><u>Cross References</u> Fram CFA9404 Mann CUK2545 Micronair MC560 Purflux AHC191 Tecocar EC394 Fiaam PCK8092</p>
	<p>I Il filtro è posizionato nell'abitacolo sotto il vano portaoggetti</p> <p>GB The filter is located in the passenger compartment under the glove compartment</p> <p>F Le filtre est situé dans l'habitacle en dessous de la boîte à gants</p> <p>D Der filter befindet sich im Fahrgastraum unter dem Handsuhfach</p> <p>E El filtro se encuentra en el habitáculo, bajo la guantera de pasajerruimte</p>				

<p>--- Scirocco III (1K8) ---</p>	10/08 ->	*	*	<p>CK 9922 286/280 x 214 x 34/57</p> <p><u>O/E numbers</u> V.A.G. 1K0819644 / 1K0819644A</p> <p><u>Cross References</u> Fram CF9922 Mann CU2939 Micronair MP113 Purflux AH202 Tecocar E409 Fiaam PC8155</p>	<p>CK 9922-C 286/280 x 214 x 34/57</p> <p><u>O/E numbers</u> V.A.G. 1K1819653 / 1K1819653A</p> <p><u>Cross References</u> Fram CFA9921 Mann CUK2939 Micronair MC613 Purflux AHC202 Tecocar EC409 Fiaam PCK8155</p>
	<p>I Il filtro è posizionato nell'abitacolo sotto il vano portaoggetti</p> <p>GB The filter is located in the passenger compartment under the glove compartment</p> <p>F Le filtre est situé dans l'habitacle en dessous de la boîte à gants</p> <p>D Der filter befindet sich im Fahrgastraum unter dem Handsuhfach</p> <p>E El filtro se encuentra en el habitáculo, bajo la guantera de pasajerruimte</p>				



Anti-pollen

Activated carbon

VOLKSWAGEN

--- Sharan ---

06/95 ->

*

*

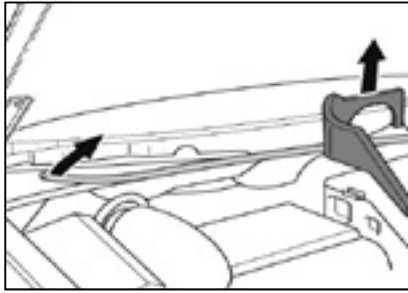

- I** Il filtro è posizionato nel vano motore sul lato passeggero
- GB** The filter is located in the engine compartment on the passenger's side
- F** Le filtre est situé dans le compartiment moteur du côté passager
- D** Der filter befindet sich Motorraum auf der Beifahrerseite
- E** El filtro se encuentra en el compartimiento del motor, del lado del acompañante

CK 5850

535 x 109 x 25,5



O/E numbers

V.A.G. 7M0819638A / 7M0819644

Cross References

Fram CF5850 Mann CU5480
Micronair MP025 Purflux AH129
Tecnocar E329 Fiaam PC8024

CK 5850-C

535 x 109,5 x 25,5



O/E numbers

V.A.G. 7M0091800SE / 7M3819644A

Cross References

Fram CFA8878 Mann CUK5480
Micronair MC525 Purflux AHC129
Tecnocar..... Fiaam PCK8066

--- Sharan II ---

08/10 ->

*

*

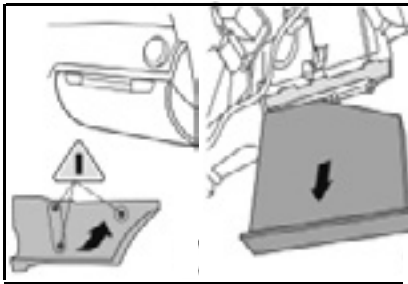

- I** Il filtro è posizionato nell'abitacolo sotto il vano portaoggetti
- GB** The filter is located in the passenger compartment under the glove compartment
- F** Le filtre est situé dans l'habitacle en dessous de la boîte à gants
- D** Der filter befindet sich im Fahrgastraum unter dem Handschuhfach
- E** El filtro se encuentra en el habitáculo, bajo la guanterain de pasajerruimte

CK 9922

286/280 x 214 x 34/57



O/E numbers

V.A.G. 1K0819644 / 1K0819644A

Cross References

Fram CF9922 Mann CU2939
Micronair MP113 Purflux AH202
Tecnocar E409 Fiaam PC8155

CK 9922-C

286/280 x 214 x 34/57



O/E numbers

V.A.G. 1K1819653 / 1K1819653A

Cross References

Fram CFA9921 Mann CUK2939
Micronair MC613 Purflux AHC202
Tecnocar EC409 Fiaam PCK8155

--- Tiguan ---

11/07 ->

*

*

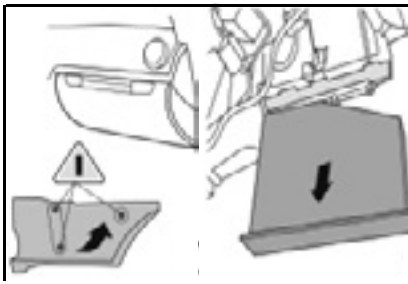

- I** Il filtro è posizionato nell'abitacolo sotto il vano portaoggetti
- GB** The filter is located in the passenger compartment under the glove compartment
- F** Le filtre est situé dans l'habitacle en dessous de la boîte à gants
- D** Der filter befindet sich im Fahrgastraum unter dem Handschuhfach
- E** El filtro se encuentra en el habitáculo, bajo la guanterain de pasajerruimte

CK 9922

286/280 x 214 x 34/57



O/E numbers

V.A.G. 1K0819644 / 1K0819644A

Cross References

Fram CF9922 Mann CU2939
Micronair MP113 Purflux AH202
Tecnocar E409 Fiaam PC8155

CK 9922-C

286/280 x 214 x 34/57



O/E numbers

V.A.G. 1K1819653 / 1K1819653A

Cross References

Fram CFA9921 Mann CUK2939
Micronair MC613 Purflux AHC202
Tecnocar EC409 Fiaam PCK8155

--- Tiguan II (5T) ---

08/15 ->

*

*

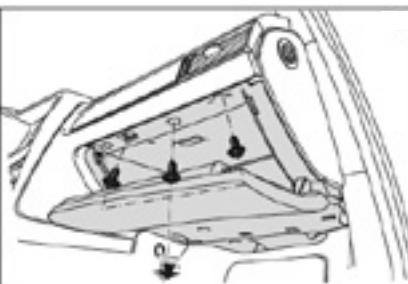

- I** Il filtro è posizionato nell'abitacolo sotto il vano portaoggetti
- GB** The filter is located in the passenger compartment under the glove compartment
- F** Le filtre est situé dans l'habitacle en dessous de la boîte à gants
- D** Der filter befindet sich im Fahrgastraum unter dem Handschuhfach
- E** El filtro se encuentra en el habitáculo, bajo la guanterain de pasajerruimte

CK 26009

253 x 234 x 30



O/E numbers

V.A.G. 5Q0819644 / 5Q0819644A

Cross References

Fram Mann CU26009
Micronair MP437 Purflux
Tecnocar Fiaam

CK 26009-C

253 x 234 x 30



O/E numbers

V.A.G. 5Q0819653

Cross References

Fram CFA11643 Mann CUK26009
Micronair MC937 Purflux AHC392
Tecnocar EC683 Fiaam PCK8361

--- Touareg ---

10/02 -> 04/10

*

*

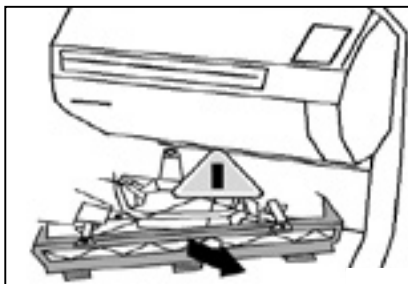

- I** Il filtro è posizionato nell'abitacolo sotto il vano portaoggetti
- GB** The filter is located in the passenger compartment under the glove compartment
- F** Le filtre est situé dans l'habitacle en dessous de la boîte à gants
- D** Der filter befindet sich im Fahrgastraum unter dem Handschuhfach
- E** El filtro se encuentra en el habitáculo, bajo la guanterain de pasajerruimte

CK 9881

227 x 218 x 31



O/E numbers

V.A.G. 7H0819631

Cross References

Fram CF9881 Mann CU2842
Micronair MP141 Purflux AH209
Tecnocar E413 Fiaam PC8158

CK 9881-C

227 x 218 x 31



O/E numbers

V.A.G. 7H0819631A

Cross References

Fram..... Mann CUK2842
Micronair MC641 Purflux.....
Tecnocar..... Fiaam.....



Anti-pollen

Activated carbon

VOLKSWAGEN

--- Touareg II (7P) ---

04/10 -> * *

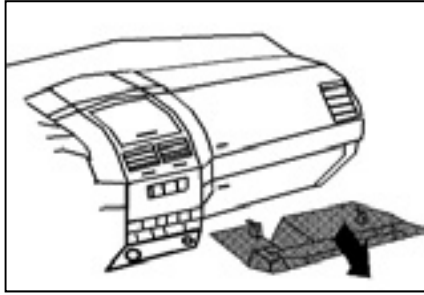

- I** Il filtro è posizionato nell'abitacolo sotto il vano portaoggetti
- GB** The filter is located in the passenger compartment under the glove compartment
- F** Le filtre est situé dans l'habitacle en dessous de la boîte à gants
- D** Der filter befindet sich im Fahrgastraum unter dem Handsuhfach
- E** El filtro se encuentra en el habitáculo, bajo la guanterain de passagjerruimte

CK 2847-C

278 X 220 X 40



O/E numbers

V.A.G. 7P0819631

Cross References

Fram CFA11429 Mann CUK2847
 Micronair MC917 Purflux AHC353
 Tecocar EC646 Fiaam PCK8321

--- Touran (1T) ---

02/03 -> * *

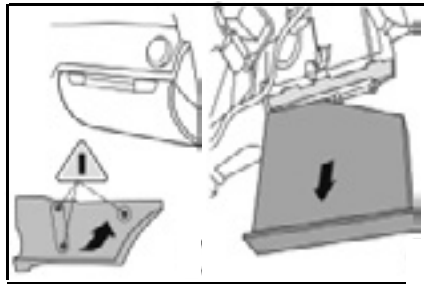

- I** Il filtro è posizionato nell'abitacolo sotto il vano portaoggetti
- GB** The filter is located in the passenger compartment under the glove compartment
- F** Le filtre est situé dans l'habitacle en dessous de la boîte à gants
- D** Der filter befindet sich im Fahrgastraum unter dem Handsuhfach
- E** El filtro se encuentra en el habitáculo, bajo la guanterain de passagjerruimte

CK 9922

286/280 x 214 x 34/57



O/E numbers

V.A.G. 1K0819644 / 1K0819644A

Cross References

Fram CF9922 Mann CU2939
 Micronair MP113 Purflux AH202
 Tecocar E409 Fiaam PC8155

CK 9922-C

286/280 x 214 x 34/57



O/E numbers

V.A.G. 1K1819653 / 1K1819653A

Cross References

Fram CFA9921 Mann CUK2939
 Micronair MC613 Purflux AHC202
 Tecocar EC409 Fiaam PCK8155

--- Touran (5T) ---

05/15 -> * *

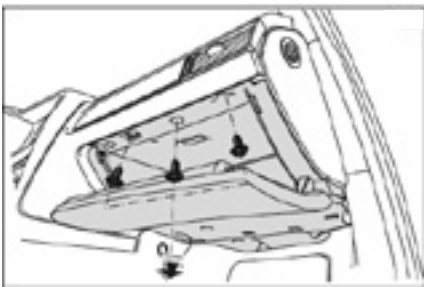

- I** Il filtro è posizionato nell'abitacolo sotto il vano portaoggetti
- GB** The filter is located in the passenger compartment under the glove compartment
- F** Le filtre est situé dans l'habitacle en dessous de la boîte à gants
- D** Der filter befindet sich im Fahrgastraum unter dem Handsuhfach
- E** El filtro se encuentra en el habitáculo, bajo la guanterain de passagjerruimte

CK 26009

253 x 234 x 30



O/E numbers

V.A.G. 5Q0819644 / 5Q0819644A

Cross References

Fram Mann CU26009
 Micronair MP437 Purflux
 Tecocar Fiaam

CK 26009-C

253 x 234 x 30



O/E numbers

V.A.G. 5Q0819653

Cross References

Fram CFA11643 Mann CUK26009
 Micronair MC937 Purflux AHC392
 Tecocar EC683 Fiaam PCK8361

--- Transporter / Vans (T4) ---

09/90 -> 05/03 * *

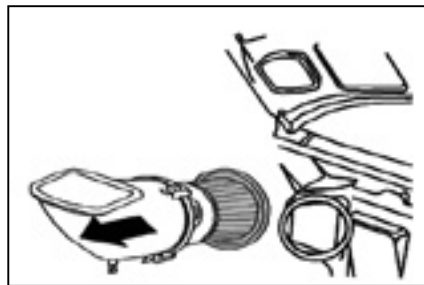

- I** Il filtro è posizionato nel vano motore sul lato passeggero
- GB** The filter is located in the engine compartment on the passenger's side
- F** Le filtre est situé dans le compartiment moteur du côté passager
- D** Der filter befindet sich Motorraum auf der Beifahrerseite
- E** El filtro se encuentra en el compartimiento del motor, del lado del acompañante

CK 9579

Ø 168 H 102



O/E numbers

V.A.G. 7038119989 / 7D0819989

Cross References

Fram CF9579 Mann CU1738
 Micronair MP024 Purflux AH182
 Tecocar E385 Fiaam PC8107

--- Transporter / Vans (T5) ---

05/03 -> * *

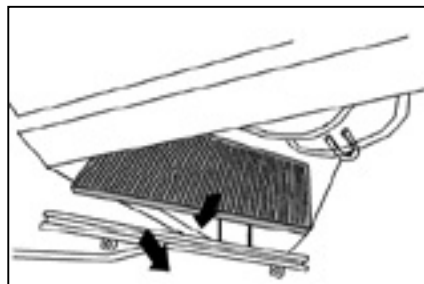

- I** Il filtro è posizionato nell'abitacolo sotto il vano portaoggetti
- GB** The filter is located in the passenger compartment under the glove compartment
- F** Le filtre est situé dans l'habitacle en dessous de la boîte à gants
- D** Der filter befindet sich im Fahrgastraum unter dem Handsuhfach
- E** El filtro se encuentra en el habitáculo, bajo la guanterain de passagjerruimte

CK 9881

227 x 218 x 31



O/E numbers

V.A.G. 7H0819631

Cross References

Fram CF9881 Mann CU2842
 Micronair MP141 Purflux AH209
 Tecocar E413 Fiaam PC8158

CK 9881-C

227 x 218 x 31



O/E numbers

V.A.G. 7H0819631A

Cross References

Fram..... Mann CUK2842
 Micronair MC641 Purflux.....
 Tecocar..... Fiaam.....



Anno di fabbricazione / Year of construction
 Anné de fabrication / Baujahr / Año de fabricaciór



Con climatizzatore / With air-conditioning / Avec climatisation
 Mit Klimaanlage / Con instalación de aire acondicionado



Senza climatizzatore / Without air-conditioning / Sans climatisation
 Ohne Klimaanlage / Sin instalación de aire acondicionado



Anti-pollen

Activated carbon

VOLKSWAGEN

--- Transporter / Vans (T6) ---

04/15 ->

*

*

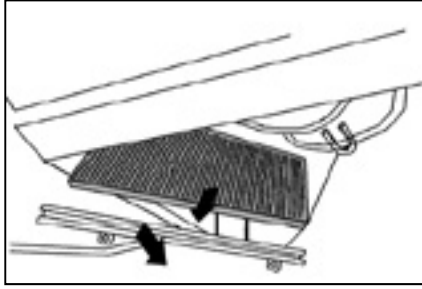

- I** Il filtro è posizionato nell'abitacolo sotto il vano portaoggetti
- GB** The filter is located in the passenger compartment under the glove compartment
- F** Le filtre est situé dans l'habitacle en dessous de la boîte à gants
- D** Der filter befindet sich im Fahrgastraum unter dem Handschuhfach
- E** El filtro se encuentra en el habitáculo, bajo la guanterain de pasajgeriunte

CK 9881

227 x 218 x 31



O/E numbers

V.A.G. 7H0819631

Cross References

Fram CF9881 Mann CU2842
 Micronair MP141 Purflux AH209
 Tecocar E413 Fiaam PC8158

CK 9881-C

227 x 218 x 31



O/E numbers

V.A.G. 7H0819631A

Cross References

Fram..... Mann CUK2842
 Micronair MC641 Purflux.....
 Tecocar..... Fiaam.....

--- Up ---

11/11 ->

*

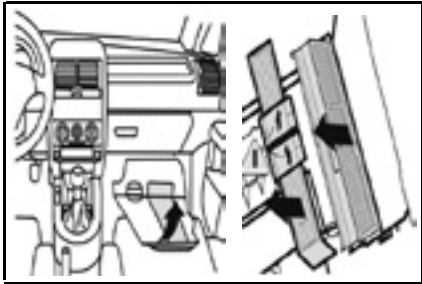

- I** Il filtro è posizionato nell'abitacolo dietro il vano portaoggetti
- GB** The filter is located in the passenger compartment behind the glove compartment
- F** Le filtre est situé dans l'habitacle derrière la boîte à gants
- D** Der filter befindet sich im Fahrgastraum hinter dem Handschuhfach
- E** El filtro se encuentra en el habitáculo detrás de la guantera

CK 26006

254 x 182 x 35

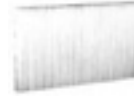

O/E numbers

V.A.G. 1S0820367

Cross References

Fram CF11464 Mann CU26006
 Micronair MP421 Purflux AH370
 Tecocar E664 Fiaam PC8339

--- Vento ---

11/91 -> 07/93

*

*

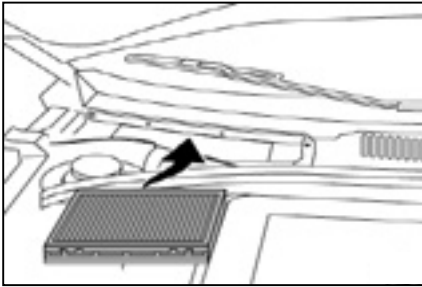

- I** Il filtro è posizionato nel vano motore sul lato passeggero
- GB** The filter is located in the engine compartment on the passenger's side
- F** Le filtre est situé dans le compartiment moteur du côté passager
- D** Der filter befindet sich Motorraum auf der Beifahrerseite
- E** El filtro se encuentra en el compartimiento del motor, del lado del acompañante

CK 5474

278/268 x 208 x 40



O/E numbers

V.A.G. 1H0819698

Cross References

Fram CF5474 Mann.....
 Micronair..... Purflux.....
 Tecocar..... Fiaam PC8001

--- Vento ---

08/93 -> 09/98

*

*

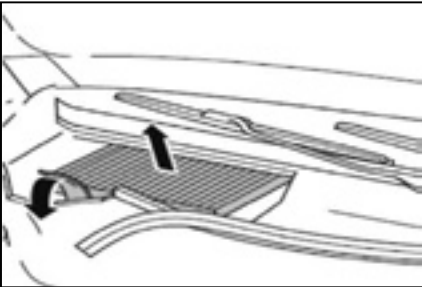

- I** Il filtro è posizionato nel vano motore sul lato passeggero
- GB** The filter is located in the engine compartment on the passenger's side
- F** Le filtre est situé dans le compartiment moteur du côté passager
- D** Der filter befindet sich Motorraum auf der Beifahrerseite
- E** El filtro se encuentra en el compartimiento del motor, del lado del acompañante

CK 5663

280 x 206 x 25



O/E numbers

V.A.G. 1H0819644A / 1H0819638A

Cross References

Fram CF5663 Mann CU2882
 Micronair MP044 Purflux AH104
 Tecocar E311 Fiaam PC8005

CK 5663-C

280 x 206 x 25



O/E numbers

V.A.G. 1H0091800 / 8L0091800

Cross References

Fram CFA8893 Mann CUK2882
 Micronair MC544 Purflux AHC104
 Tecocar Fiaam PCK8072

--- Vento India (602) ---

07/10 ->

*

*

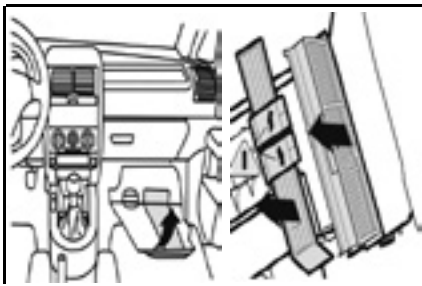

- I** Il filtro è posizionato nell'abitacolo sotto il vano portaoggetti
- GB** The filter is located in the passenger compartment under the glove compartment
- F** Le filtre est situé dans l'habitacle en dessous de la boîte à gants
- D** Der filter befindet sich im Fahrgastraum unter dem Handschuhfach
- E** El filtro se encuentra en el habitáculo, bajo la guanterain de pasajgeriunte

CK 9323

251 x 215 x 32
for mounting with plastic frame



O/E numbers

V.A.G. 6Q0820367

Cross References

Fram CF9323 Mann CU2545
 Micronair MP060 Purflux AH191
 Tecocar E394 Fiaam PC8077

CK 9323-C

251 x 215 x 32
for mounting with plastic frame

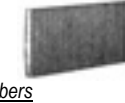

O/E numbers

V.A.G. 6Q0819653 / 6Q0820367-S

Cross References



Fram CFA9404 Mann CUK2545
 Micronair MC560 Purflux AHC191
 Tecocar EC394 Fiaam PCK8092



Anti-pollen

Activated carbon

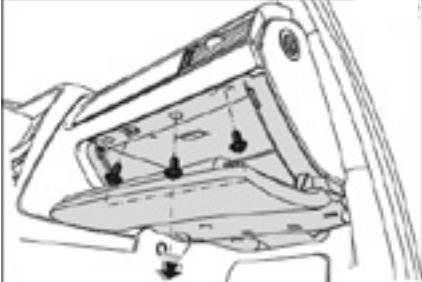
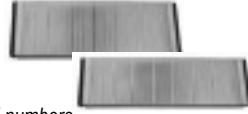
VOLKSWAGEN

<p>--- XL1 ---</p> 	<p>05/13 -></p>	<p>*</p>	<p>*</p>	<p>CK 10209-2 306/296 x 100 x 30</p>  <p><u>O/E numbers</u> V.A.G. 4F0819439 / 4F0898438</p> <p><u>Cross References</u> Fram..... Mann CU3023 Micronair MP185 Puflex..... Tecnocar..... Fiaam.....</p>	<p>CK 10209-C-2 306/296 x 100 x 30</p>  <p><u>O/E numbers</u> V.A.G. 4F0819439A / 4F0898438A</p> <p><u>Cross References</u> Fram CFA10209-2 Mann CUK3023 Micronair MC685 Puflex AHC247 Tecnocar EC449 Fiaam PCK8171-2</p>
---	--------------------	----------	----------	---	---

--	--	--

--	--	--

--	--	--









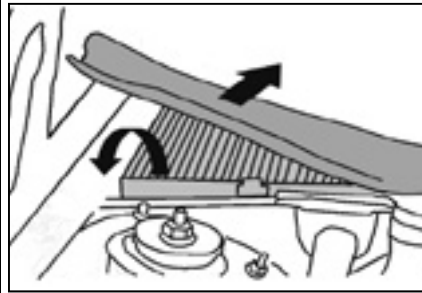

--	--	--

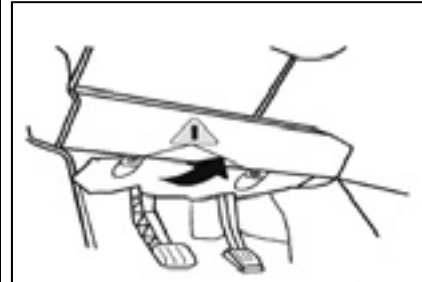

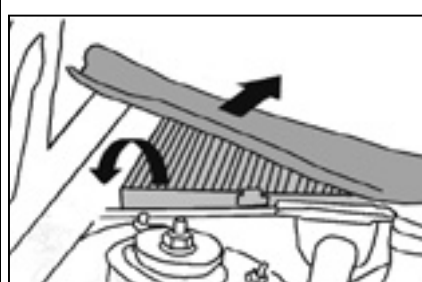
Anti-pollen

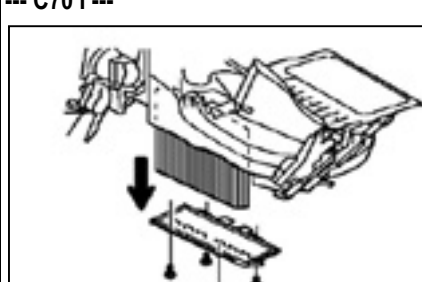
Activated carbon

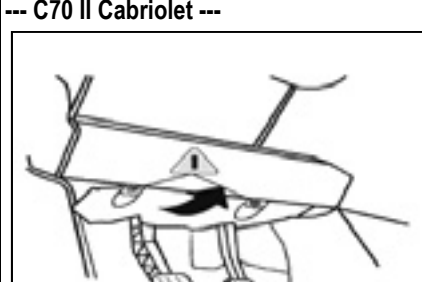
VOLVO

<p>--- 850 ---</p> 	<p>06/91 -> 12/96</p> <p>* *</p> <p>① Il filtro è posizionato nel vano motore al centro ② The filter is located in the engine compartment centrally ③ Le filtre est situé dans le compartiment moteur au centre ④ Der Filter befindet sich im Motorraum mittig ⑤ El filtro se encuentra en el compartimiento del motor, en el centro</p>	<p>CK 8714 256 x 166 x 29</p>  <p><u>O/E numbers</u> Volvo 9171296 / 9192522</p> <p><u>Cross References</u> Fram CF8714/CF5853 Mann CU2650 Micronair MP069 Purflux AH149 Tecocar..... Fiaam PC8050</p>	<p>CK 8714-C 256 x 166 x 29</p>  <p><u>O/E numbers</u> Volvo 9488527 / 9488528</p> <p><u>Cross References</u> Fram CFA8714 Mann..... Micronair MC569 Purflux AHC149 Tecocar EC378 Fiaam PCK8050</p>
<p>--- C30 ---</p> 	<p>12/06 -></p> <p>* </p> <p>① Il filtro è posizionato nell'abitacolo sul lato conducente ② The filter is located in the passenger compartment on the driver's side ③ Le filtre est situé dans l'habitacle du côté conducteur ④ Der Filter befindet sich im Fahrgastraum auf der Fahrerseite ⑤ El Filtro se encuentra en el habitáculo, del lado del conductor</p>	<p>CK 10059 233 x 209 x 35</p>  <p><u>O/E numbers</u> Volvo 8687389</p> <p><u>Cross References</u> Fram CF10059 Mann CU2440 Micronair MP145/MP181 Purflux AH238 Tecocar E442 Fiaam PC8161</p>	<p>CK 10059-C 233 x 209 x 35</p>  <p><u>O/E numbers</u> Volvo 30676484</p> <p><u>Cross References</u> Fram CFA10527 Mann CUK2440 Micronair MC645/MC681 Purflux ACH238 Tecocar EC484 Fiaam PCK8124</p>
<p>--- C70 I ---</p> 	<p>06/97 -> 07/00</p> <p>* *</p> <p>① Il filtro è posizionato nel vano motore al centro ② The filter is located in the engine compartment centrally ③ Le filtre est situé dans le compartiment moteur au centre ④ Der Filter befindet sich im Motorraum mittig ⑤ El filtro se encuentra en el compartimiento del motor, en el centro</p>	<p>CK 8714 256 x 166 x 29</p>  <p><u>O/E numbers</u> Volvo 9171296 / 9192522</p> <p><u>Cross References</u> Fram CF8714/CF5853 Mann CU2650 Micronair MP069 Purflux AH149 Tecocar..... Fiaam PC8050</p>	<p>CK 8714-C 256 x 166 x 29</p>  <p><u>O/E numbers</u> Volvo 9488527 / 9488528</p> <p><u>Cross References</u> Fram CFA8714 Mann..... Micronair MC569 Purflux AHC149 Tecocar EC378 Fiaam PCK8050</p>
<p>--- C70 I ---</p> 	<p>08/00 -> 09/05</p> <p>* </p> <p>① Il filtro è posizionato nell'abitacolo sotto il vano portaoggetti ② The filter is located in the passenger compartment under the glove compartment ③ Le filtre est situé dans l'habitacle en dessous de la boîte à gants ④ Der filter befindet sich im Fahrgastraum unter dem Handschuhfach ⑤ El filtro se encuentra en el habitáculo, bajo la guanterain de pasajerruimte</p>	<p>CK 9396 264 x 276/258 x 25</p>  <p><u>O/E numbers</u> Volvo 9204626</p> <p><u>Cross References</u> Fram CF9396 Mann CU2855 Micronair MP086 Purflux AH173 Tecocar E369 Fiaam PC8085</p>	<p>CK 9396-C 264 x 276/258 x 25</p>  <p><u>O/E numbers</u> Volvo 9171756 / 30676413</p> <p><u>Cross References</u> Fram CFA9396 Mann CUK2855 Micronair MC646 Purflux AHC173 Tecocar..... Fiaam PCK8085</p>
<p>--- C70 II Cabriolet ---</p> 	<p>03/06 -></p> <p>* </p> <p>① Il filtro è posizionato nell'abitacolo sul lato conducente ② The filter is located in the passenger compartment on the driver's side ③ Le filtre est situé dans l'habitacle du côté conducteur ④ Der Filter befindet sich im Fahrgastraum auf der Fahrerseite ⑤ El Filtro se encuentra en el habitáculo, del lado del conductor</p>	<p>CK 10059 233 x 209 x 35</p>  <p><u>O/E numbers</u> Volvo 8687389</p> <p><u>Cross References</u> Fram CF10059 Mann CU2440 Micronair MP145/MP181 Purflux AH238 Tecocar E442 Fiaam PC8161</p>	<p>CK 10059-C 233 x 209 x 35</p>  <p><u>O/E numbers</u> Volvo 30676484</p> <p><u>Cross References</u> Fram CFA10527 Mann CUK2440 Micronair MC645/MC681 Purflux ACH238 Tecocar EC484 Fiaam PCK8124</p>







Anti-pollen

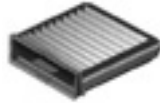

Activated carbon

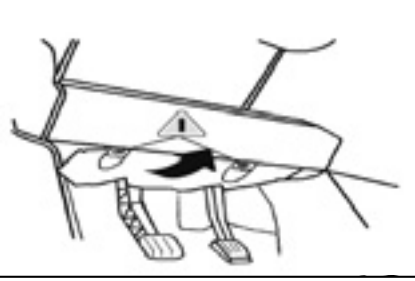

VOLVO

<p>--- S40 I ---</p> 	<p>07/95 -> 12/99</p> <p style="text-align: right;">*</p>	<p>CK 9880</p> <p>194 x 175 x 42/50,5</p>  <p><u>O/E numbers</u> Volvo 30818694 / 308186949</p> <p><u>Cross References</u> Fram CF9880 Mann CU1915 Micronair MP349 Purflux AH148 Tecnicar E350 Fiaam.....</p>	<p>---</p>
---	--	---	------------

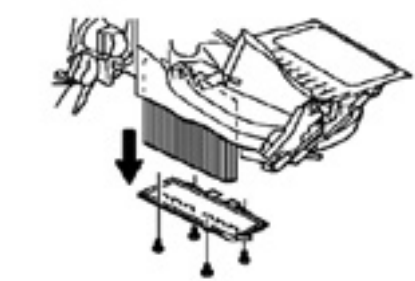
<p>--- S40 I ---</p> 	<p>01/00 -> 02/04</p> <p style="text-align: right;">*</p>	<p>CK 9336</p> <p>227 x 209 x 20</p>  <p><u>O/E numbers</u> Volvo 30612666</p> <p><u>Cross References</u> Fram CF9336 Mann CU2137 Micronair MP085 Purflux AH289 Tecnicar E436 Fiaam PC8082</p>	<p>CK 9336-C</p> <p>227 x 209 x 20</p>  <p><u>O/E numbers</u> Volvo 30662349 / 30883952</p> <p><u>Cross References</u> Fram..... Mann CUK2137 Micronair MC585 Purflux..... Tecnicar..... Fiaam.....</p>
---	--	--	--

<p>--- S40 II ---</p> 	<p>02/04 -></p> <p style="text-align: right;">*</p>	<p>CK 10059</p> <p>233 x 209 x 35</p>  <p><u>O/E numbers</u> Volvo 8687389</p> <p><u>Cross References</u> Fram CF10059 Mann CU2440 Micronair MP145/MP181 Purflux AH238 Tecnicar E442 Fiaam PC8161</p>	<p>CK 10059-C</p> <p>233 x 209 x 35</p>  <p><u>O/E numbers</u> Volvo 30676484</p> <p><u>Cross References</u> Fram CFA10527 Mann CUK2440 Micronair MC645/MC681 Purflux AHC238 Tecnicar EC487 Fiaam PCK8214</p>
--	--	---	--

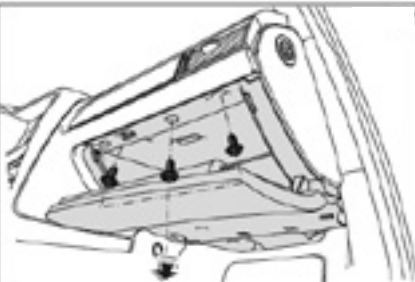
<p>--- S60 I ---</p> 	<p>01/00 -> 04/10</p> <p style="text-align: right;">*</p>	<p>CK 9396</p> <p>264 x 276/258 x 25</p>  <p><u>O/E numbers</u> Volvo 9204626</p> <p><u>Cross References</u> Fram CF9396 Mann CU2855 Micronair MP086 Purflux AH173 Tecnicar E369 Fiaam PC8085</p>	<p>CK 9396-C</p> <p>264 x 276/258 x 25</p>  <p><u>O/E numbers</u> Volvo 9171756 / 30676413</p> <p><u>Cross References</u> Fram CFA9396 Mann CUK2855 Micronair MC646 Purflux AHC173 Tecnicar..... Fiaam PCK8085</p>
---	--	---	---

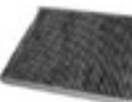







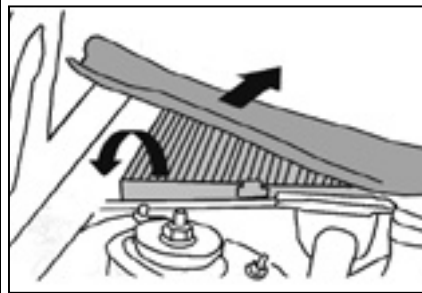

<p>--- S60 II / V60 ---</p> 	<p>07/10 -></p> <p style="text-align: right;">*</p>	<p>CK 2733</p> <p>287 x 195 x 36</p>  <p><u>O/E numbers</u> Volvo 30733894 / 30767022</p> <p><u>Cross References</u> Fram CF10442 Mann CU2733 Micronair MC808 Purflux AH267 Tecnicar E469 Fiaam PC8197</p>	<p>CK 2733-C</p> <p>287 x 195 x 36</p>  <p><u>O/E numbers</u> Volvo 30733893 / 30767024</p> <p><u>Cross References</u> Fram CFA10435 Mann CUK2733 Micronair Purflux AHC267 Tecnicar EC469 Fiaam</p>
--	--	--	--

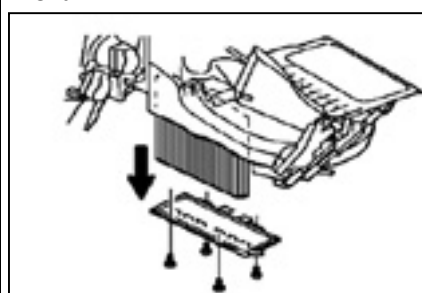

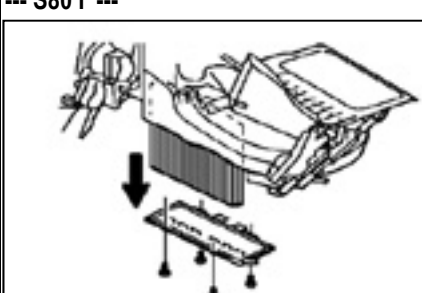
Anti-pollen

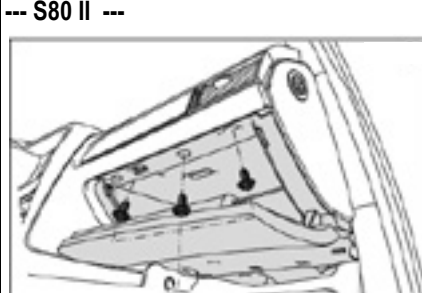
Activated carbon

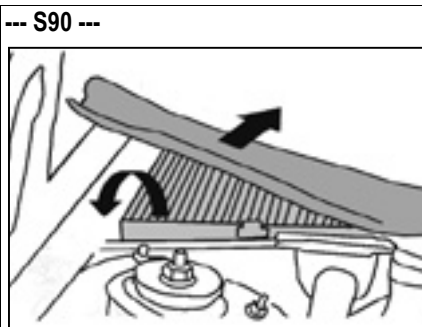
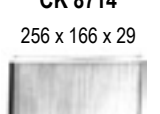
VOLVO

<p>--- S70 ---</p> 	<p>01/97 -> 12/00</p> <p>* *</p> <p>I Il filtro è posizionato nel vano motore al centro GB The filter is located in the engine compartment centrally F Le filtre est situé dans le compartiment moteur au centre D Der Filter befindet sich im Motorraum mitting E El filtro se encuentra en el compartimiento del motor, en el centro</p>	<p>CK 8714 256 x 166 x 29</p>  <p><u>O/E numbers</u> Volvo 9171296 / 9192522</p> <p><u>Cross References</u> Fram CF8714/CF5853 Mann CU2650 Micronair MP069 Purflux AH149 Tecnocar..... Fiaam PC8050</p>	<p>CK 8714-C 256 x 166 x 29</p>  <p><u>O/E numbers</u> Volvo 9488527 / 9488528</p> <p><u>Cross References</u> Fram CFA8714 Mann..... Micronair MC569 Purflux AHC149 Tecnocar EC378 Fiaam PCK8050</p>
<p>--- S70 ---</p> 	<p>07/00 -></p> <p>* </p> <p>I Il filtro è posizionato nell'abitacolo sotto il vano portaoggetti GB The filter is located in the passenger compartment under the glove compartment F Le filtre est situé dans l'habitacle en dessous de la boîte à gants D Der filter befindet sich im Fahrgastraum unter dem Handshuhfach E El filtro se encuentra en el habitáculo, bajo la guanterain de pasajerruimte</p>	<p>CK 9396 264 x 276/258 x 25</p>  <p><u>O/E numbers</u> Volvo 9204626</p> <p><u>Cross References</u> Fram CF9396 Mann CU2855 Micronair MP086 Purflux AH173 Tecnocar E369 Fiaam PC8085</p>	<p>CK 9396-C 264 x 276/258 x 25</p>  <p><u>O/E numbers</u> Volvo 9171756 / 30676413</p> <p><u>Cross References</u> Fram CFA9396 Mann CUK2855 Micronair MC646 Purflux AHC173 Tecnocar..... Fiaam PCK8085</p>
<p>--- S80 I ---</p> 	<p>05/98 -></p> <p>* </p> <p>I Il filtro è posizionato nell'abitacolo sotto il vano portaoggetti GB The filter is located in the passenger compartment under the glove compartment F Le filtre est situé dans l'habitacle en dessous de la boîte à gants D Der filter befindet sich im Fahrgastraum unter dem Handshuhfach E El filtro se encuentra en el habitáculo, bajo la guanterain de pasajerruimte</p>	<p>CK 9396 264 x 276/258 x 25</p>  <p><u>O/E numbers</u> Volvo 9204626</p> <p><u>Cross References</u> Fram CF9396 Mann CU2855 Micronair MP086 Purflux AH173 Tecnocar E369 Fiaam PC8085</p>	<p>CK 9396-C 264 x 276/258 x 25</p>  <p><u>O/E numbers</u> Volvo 9171756 / 30676413</p> <p><u>Cross References</u> Fram CFA9396 Mann CUK2855 Micronair MC646 Purflux AHC173 Tecnocar..... Fiaam PCK8085</p>
<p>--- S80 II ---</p> 	<p>07/06 -></p> <p>* </p> <p>I Il filtro è posizionato nell'abitacolo sotto il vano portaoggetti GB The filter is located in the passenger compartment under the glove compartment F Le filtre est situé dans l'habitacle en dessous de la boîte à gants D Der filter befindet sich im Fahrgastraum unter dem Handshuhfach E El filtro se encuentra en el habitáculo, bajo la guanterain de pasajerruimte</p>	<p>CK 2733 287 x 195 x 36</p>  <p><u>O/E numbers</u> Volvo 30733894 / 30767022</p> <p><u>Cross References</u> Fram CF10442 Mann CU2733 Micronair MC808 Purflux AH267 Tecnocar E469 Fiaam PC8197</p>	<p>CK 2733-C 287 x 195 x 36</p>  <p><u>O/E numbers</u> Volvo 30733893 / 30767024</p> <p><u>Cross References</u> Fram CFA10435 Mann CUK2733 Micronair Purflux AHC267 Tecnocar EC469 Fiaam</p>
<p>--- S90 ---</p> 	<p>11/96 -> 10/98</p> <p>* *</p> <p>I Il filtro è posizionato nel vano motore al centro GB The filter is located in the engine compartment centrally F Le filtre est situé dans le compartiment moteur au centre D Der Filter befindet sich im Motorraum mitting E El filtro se encuentra en el compartimiento del motor, en el centro</p>	<p>CK 8714 256 x 166 x 29</p>  <p><u>O/E numbers</u> Volvo 9171296 / 9192522</p> <p><u>Cross References</u> Fram CF8714/CF5853 Mann CU2650 Micronair MP069 Purflux AH149 Tecnocar..... Fiaam PC8050</p>	<p>CK 8714-C 256 x 166 x 29</p>  <p><u>O/E numbers</u> Volvo 9488527 / 9488528</p> <p><u>Cross References</u> Fram CFA8714 Mann..... Micronair MC569 Purflux AHC149 Tecnocar EC378 Fiaam PCK8050</p>







Anti-pollen

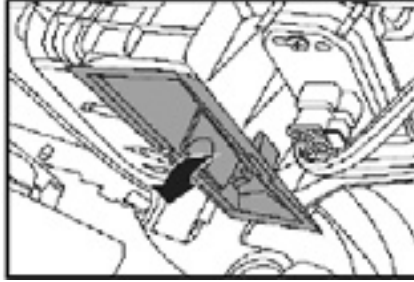
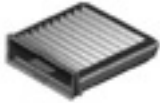

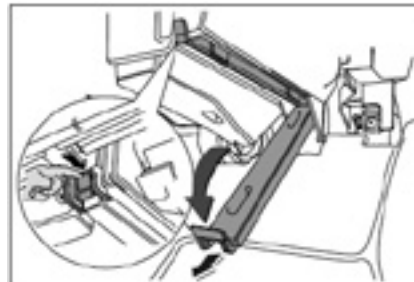
Activated carbon

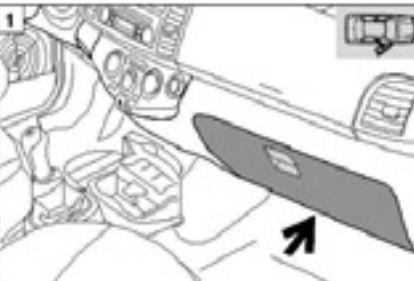

VOLVO

<p>--- V40 I ---</p> 	<p>07/95 -> 12/99</p> <p style="text-align: right;">*</p>	<p>CK 9880 194 x 175 x 42/50,5</p>  <p><u>O/E numbers</u> Volvo 30818694 / 308186949</p> <p><u>Cross References</u> Fram CF9880 Mann CU1915 Micronair MP349 Purflux AH148 Tecnicar E350 Fiaam.....</p>	
--	--	--	--

<p>--- V40 I ---</p> 	<p>01/00 -> 05/04</p> <p style="text-align: right;">*</p>	<p>CK 9336 227 x 209 x 20</p>  <p><u>O/E numbers</u> Volvo 30612666</p> <p><u>Cross References</u> Fram CF9336 Mann CU2137 Micronair MP085 Purflux AH289 Tecnicar E436 Fiaam PC8082</p>	<p>CK 9336-C 227 x 209 x 20</p>  <p><u>O/E numbers</u> Volvo 30662349 / 30883952</p> <p><u>Cross References</u> Fram..... Mann CUK2137 Micronair MC585 Purflux..... Tecnicar..... Fiaam.....</p>
--	--	---	---

<p>--- V40 II / V40 Cross Country ---</p> 	<p>06-dic</p> <p style="text-align: right;">* *</p>	<p>CK 25007 256 x 203,5 x 35</p>  <p><u>O/E numbers</u> Volvo 31369456 / 31404959</p> <p><u>Cross References</u> Fram CF11661 Mann CU25007 Micronair Purflux AH395 Tecnicar Fiaam PC8364</p>	<p>CK 25007-C 256 x 203,5 x 35</p>  <p><u>O/E numbers</u> Volvo 31369455 / 31404958</p> <p><u>Cross References</u> Fram CFA11642 Mann CUK25007 Micronair Purflux AHC391 Tecnicar EC682 Fiaam PCK8360</p>
---	--	--	---

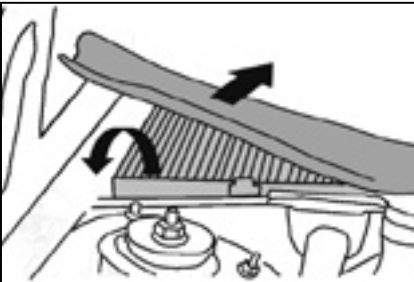
<p>--- V50 ---</p> 	<p>04/04 -></p> <p style="text-align: right;">*</p>	<p>CK 10059 233 x 209 x 35</p>  <p><u>O/E numbers</u> Volvo 8687389</p> <p><u>Cross References</u> Fram CF10059 Mann CU2440 Micronair MP145/MP181 Purflux AH238 Tecnicar E442 Fiaam PC8161</p>	<p>CK 10059-C 233 x 209 x 35</p>  <p><u>O/E numbers</u> Volvo 30676484</p> <p><u>Cross References</u> Fram CFA10527 Mann CUK2440 Micronair MC645/MC681 Purflux AHC238 Tecnicar EC487 Fiaam PCK8214</p>
--	--	--	---

<p>--- V70 I ---</p> 	<p>01/97 -> 06/00</p> <p style="text-align: right;">* *</p>	<p>CK 8714 256 x 166 x 29</p>  <p><u>O/E numbers</u> Volvo 9171296 / 9192522</p> <p><u>Cross References</u> Fram CF8714/CF5853 Mann CU2650 Micronair MP069 Purflux AH149 Tecnicar..... Fiaam PC8050</p>	<p>CK 8714-C 256 x 166 x 29</p>  <p><u>O/E numbers</u> Volvo 9488527 / 9488528</p> <p><u>Cross References</u> Fram CFA8714 Mann..... Micronair MC569 Purflux AHC149 Tecnicar EC378 Fiaam PCK8050</p>
--	---	---	---



Anti-pollen

Activated carbon

VOLVO

<p>--- V70 I ---</p>	07/00 -> 09/07	*		<p>CK 9396 264 x 276/258 x 25</p> <p><u>O/E numbers</u> Volvo 9204626</p> <p><u>Cross References</u> Fram CF9396 Mann CU2855 Micronair MP086 Purflux AH173 Tecocar E369 Fiaam PC8085</p>	<p>CK 9396-C 264 x 276/258 x 25</p> <p><u>O/E numbers</u> Volvo 9171756 / 30676413</p> <p><u>Cross References</u> Fram CFA9396 Mann CUK2855 Micronair MC646 Purflux AHC173 Tecocar..... Fiaam PCK8085</p>
	<p>I Il filtro è posizionato nell'abitacolo sotto il vano portaoggetti</p> <p>GB The filter is located in the passenger compartment under the glove compartment</p> <p>F Le filtre est situé dans l'habitacle en dessous de la boîte à gants</p> <p>D Der filter befindet sich im Fahrgastraum unter dem Handshuhfach</p> <p>E El filtro se encuentra en el habitáculo, bajo la guantera de pasajerruimte</p>				

<p>--- V70 II ---</p>	08/07 ->	*		<p>CK 2733 287 x 195 x 36</p> <p><u>O/E numbers</u> Volvo 30733894 / 30767022</p> <p><u>Cross References</u> Fram CF10442 Mann CU2733 Micronair MC808 Purflux AH267 Tecocar E469 Fiaam PC8197</p>	<p>CK 2733-C 287 x 195 x 36</p> <p><u>O/E numbers</u> Volvo 30733893 / 30767024</p> <p><u>Cross References</u> Fram CFA10435 Mann CUK2733 Micronair Purflux AHC267 Tecocar EC469 Fiaam</p>
	<p>I Il filtro è posizionato nell'abitacolo sotto il vano portaoggetti</p> <p>GB The filter is located in the passenger compartment under the glove compartment</p> <p>F Le filtre est situé dans l'habitacle en dessous de la boîte à gants</p> <p>D Der filter befindet sich im Fahrgastraum unter dem Handshuhfach</p> <p>E El filtro se encuentra en el habitáculo, bajo la guantera de pasajerruimte</p>				

<p>--- V90 ---</p>	11/96 -> 10/98	*	*	<p>CK 8714 256 x 166 x 29</p> <p><u>O/E numbers</u> Volvo 9171296 / 9192522</p> <p><u>Cross References</u> Fram CF8714/CF5853 Mann CU2650 Micronair MP069 Purflux AH149 Tecocar..... Fiaam PC8050</p>	<p>CK 8714-C 256 x 166 x 29</p> <p><u>O/E numbers</u> Volvo 9488527 / 9488528</p> <p><u>Cross References</u> Fram CFA8714 Mann..... Micronair MC569 Purflux AHC149 Tecocar EC378 Fiaam PCK8050</p>
	<p>I Il filtro è posizionato nel vano motore al centro</p> <p>GB The filter is located in the engine compartment centrally</p> <p>F Le filtre est situé dans le compartiment moteur au centre</p> <p>D Der Filter befindet sich im Motorraum mitting</p> <p>E El filtro se encuentra en el compartimiento del motor, en el centro</p>				

<p>--- XC60 ---</p>	04/09 ->	*		<p>CK 2733 287 x 195 x 36</p> <p><u>O/E numbers</u> Volvo 30733894 / 30767022</p> <p><u>Cross References</u> Fram CF10442 Mann CU2733 Micronair MC808 Purflux AH267 Tecocar E469 Fiaam PC8197</p>	<p>CK 2733-C 287 x 195 x 36</p> <p><u>O/E numbers</u> Volvo 30733893 / 30767024</p> <p><u>Cross References</u> Fram CFA10435 Mann CUK2733 Micronair Purflux AHC267 Tecocar EC469 Fiaam</p>
	<p>I Il filtro è posizionato nell'abitacolo sotto il vano portaoggetti</p> <p>GB The filter is located in the passenger compartment under the glove compartment</p> <p>F Le filtre est situé dans l'habitacle en dessous de la boîte à gants</p> <p>D Der filter befindet sich im Fahrgastraum unter dem Handshuhfach</p> <p>E El filtro se encuentra en el habitáculo, bajo la guantera de pasajerruimte</p>				

<p>--- XC70 ---</p>	08/02 -> 09/07	*		<p>CK 9396 264 x 276/258 x 25</p> <p><u>O/E numbers</u> Volvo 9204626</p> <p><u>Cross References</u> Fram CF9396 Mann CU2855 Micronair MP086 Purflux AH173 Tecocar E369 Fiaam PC8085</p>	<p>CK 9396-C 264 x 276/258 x 25</p> <p><u>O/E numbers</u> Volvo 9171756 / 30676413</p> <p><u>Cross References</u> Fram CFA9396 Mann CUK2855 Micronair MC646 Purflux AHC173 Tecocar..... Fiaam PCK8085</p>
	<p>I Il filtro è posizionato nell'abitacolo sotto il vano portaoggetti</p> <p>GB The filter is located in the passenger compartment under the glove compartment</p> <p>F Le filtre est situé dans l'habitacle en dessous de la boîte à gants</p> <p>D Der filter befindet sich im Fahrgastraum unter dem Handshuhfach</p> <p>E El filtro se encuentra en el habitáculo, bajo la guantera de pasajerruimte</p>				



Anti-pollen

Activated carbon

VOLVO

--- XC70 II ---

08/07 ->

*

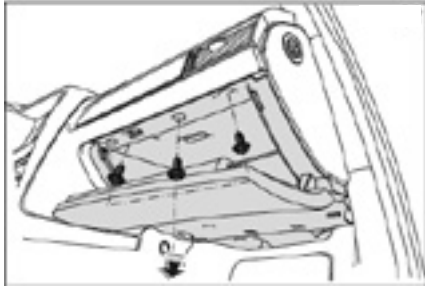

- I** Il filtro è posizionato nell'abitacolo sotto il vano portaoggetti
- GB** The filter is located in the passenger compartment under the glove compartment
- F** Le filtre est situé dans l'habitacle en dessous de la boîte à gants
- D** Der filter befindet sich im Fahrgastraum unter dem Handshuhfach
- E** El filtro se encuentra en el habitáculo, bajo la guantera de pasajerruimte

CK 2733

287 x 195 x 36



O/E numbers

Volvo 30733894 / 30767022

Cross References

Fram CF10442	Mann CU2733
Micronair MC808	Purflux AH267
Tecocar E469	Fiaam PC8197

CK 2733-C

287 x 195 x 36



O/E numbers

Volvo 30733893 / 30767024

Cross References

Fram CFA10435	Mann CUK2733
Micronair	Purflux AHC267
Tecocar EC469	Fiaam

--- XC90 ---

09/02 ->

*

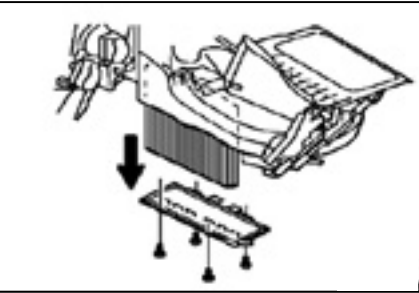

- I** Il filtro è posizionato nell'abitacolo sotto il vano portaoggetti
- GB** The filter is located in the passenger compartment under the glove compartment
- F** Le filtre est situé dans l'habitacle en dessous de la boîte à gants
- D** Der filter befindet sich im Fahrgastraum unter dem Handshuhfach
- E** El filtro se encuentra en el habitáculo, bajo la guantera de pasajerruimte

CK 9396

264 x 276/258 x 25



O/E numbers

Volvo 9204626

Cross References

Fram CF9396	Mann CU2855
Micronair MP086	Purflux AH173
Tecocar E369	Fiaam PC8085

CK 9396-C

264 x 276/258 x 25



O/E numbers

Volvo 9171756 / 30676413

Cross References

Fram CFA9396	Mann CUK2855
Micronair MC646	Purflux AHC173
Tecocar.....	Fiaam PCK8085

CORRISPONDENZE
CROSS REFERENCES



ASTER	TECNECO	ASTER	TECNECO	ASTER	TECNECO	ASTER	TECNECO	ASTER	TECNECO
1381	CK8838-C	2456 COUPLE	CK421-C-2	2631	CK25002-C	2389F	CK5852-3	2491F	CK3540
1428	CK9645-C	2458 COUPLE	CK3124-10-C-2	2633	CK26009-C	2393F	CK8777	2494F	CK10209-2
1487	CK10025-C	2459	CK9785-C	2636	CK24003-C	2394F	CK9337	2496F	CK10062
1515	CK8430-C	2461	CK9930-C	2637	CK77366480-C	2396F	CK9071	2497F	CK3139-2
1528	CK1919-C	2464	CK9586-C	2640	CK25012-C	2397F	CK8913	2501F COUPLE	CK22001-2
1555	CK10366-10-C	2468	CK9666-C	2642	CK23005-C-2	2403F	CK9322-2	2502F	CK2330
1577	CK10774-C	2470	CK9442-C	2645	CK26017-C	2404F COUPLE	CK2504	2503F	CK1910
2016	CK9051-C	2473	CK9922-C	2646	CK26010-C	2406F	CK9396	2505F	CK1719
2050	CK10436-10-C	2476	CK9881-C	2647 COUPLE	CK8838	2407F	CK3435	2506F	CK2336
2316	CK5863-C	2477	CK9904-C	1381F	CK10025	2410F	CK9363	2507F	CK10055
2318	CK5475-C	2478	CK9665-C	1487F	CK9645	2411F	CK5846	2508F	CK10059
2319	CK5665-C	2481	CK9827-C	1428F	CK8430	2412F	CK9335	2510F	CK9846
2328	CK5664-C	2482	CK10067-C	1515F	CK2542-2	2413F	CK9466	2511F	CK2434
2329	CK5663-C	2486	CK384-C	1522F	CK1919	2414F	CK9595	2514F	CK8430
2330	CK5842-C	2487	CK10025	1528F	CK10366-10	2415F	CK9905	2515F	CK207
2345	CK5851-C	2488	CK9594-C	1555F	CK10774	2416F	CK9293	2516F	CK200
2348	CK5662-C	2489	CK9562-C	1577F	CK9051	2417F	CK9640	2517F	CK2542-2
2349	CK8714-C	2491	CK9787-C	2016F	CK2952	2418F	CK9406	2522F COUPLE	CK2632-2
2350	CK5819-C	2492	CK619-C	2049F	CK10436-10	2419F	CK9396	2524F	CK2243
2352	CK5824-C	2494	CK3540-C	2050F	CK5841	2420F	CK9495	2526F	CK1919
2353	CK5848-C	2496	CK10209-C-2	2300F	CK8103	2421F	CK5366	2528F	CK2138
2356	CK5817-C	2501 COUPLE	CK3139-C-2	2314F	CK5863	2422F	CK9323	2529F	CK2012
2357	CK5850-C	2505	CK1910-C	2316F	CK5475	2423F	CK9323	2532F	CK321
2359 COUPLE	CK8912-C-2	2508	CK10055-C	2318F	CK5665	2424F	CK9405-2	2537F	CK10205-2
2362	CK5823-C	2512	CK9920-C	2319F	CK5935	2426F	CK8914-2	2540F	CK10411-10
2363	CK5846-C	2513	CK1830-C	2323F	CK5664	2427F COUPLE	CK9645	2541F	CK2544
2370	CK5818-C	2514	CK2434-C	2328F	CK5663	2428F	CK9364	2542F	CK2733
2373	CK9414-C	2515	CK8430-C	2329F	CK5842	2429F	CK5816	2544F	CK2532-10
2374	CK5942-C	2517	CK200-C	2330F	CK5864	2431F	CK5664	2546F	CK4436
2375	CK5863-C	2519	CK2747-C	2333F	CK9724	2433F	CK9336	2548F	CK2227
2376	CK8867-C	2521 COUPLE	CK2646-C-2	2340F	CK5551	2434F	CK5845	2549F	CK24004
2377	CK8778-C	2528	CK1919-C	2341F	CK5851	2435F	CK9408	2550F	CK10536-10-2
2378	CK8714-C	2529	CK2138-C	2345F	CK8947-3	2436F	CK9294	2554F COUPLE	CK10366-10
2381	CK8838-C	2539	CK1611-C	2346F	CK5662	2437F	CK2516	2555F	CK10457
2382	CK5893-C	2540	CK10205-C-2	2348F	CK8714	2440F	CK8750	2564F	CK1936
2385	CK8868-C	2541	CK10411-10-C	2349F	CK5819	2441F	CK9399	2566F	CK22004
2386	CK8831-C	2544	CK2733-C	2350F	CK5824	2444F	CK9398	2569F	CK2941-2
2387	CK9077-C	2548	CK4436-C	2352F	CK5848	2446F	CK2356	2570F COUPLE	CK10413-10
2390	CK8869-C	2549	CK2227-C	2353F	CK5972-2	2447F	CK9756	2572F	CK2028-10
2394	CK8777-C	2550	CK24004-C	2355F COUPLE	CK5817	2448F	CK9740-2	2573F	CK28004
2397	CK9071-C	2551	CK2132-C	2356F	CK5850	2450F	CK9533	2579F	CK2436-10
2400	CK9408-C	2554 COUPLE	CK10536-10-C-2	2357F	CK5847	2451F	CK9579	2583F	CK17001
2403	CK8913-C	2555	CK10366-10-C	2358F	CK8912-2	2454F	CK421-2	2588F	CK19001
2404 COUPLE	CK9322-C-2	2556	CK2230-C	2359F COUPLE	CK9545	2456F COUPLE	CK9686	2589F	CK2533-2
2407	CK9396-C	2564	CK10457-C	2360F	CK5823	2457F	CK3124-10-2	2590F	CK1811-2
2408	CK9445-C	2566	CK1936-C	2362F	CK5846	2458F COUPLE	CK9785	2592F COUPLE	CK11177
2410	CK3435-C	2567	CK29005-C	2363F	CK9338	2459F	CK9586	2593F	CK1629
2412	CK5846-C	2570 COUPLE	CK2941-C-2	2367F	CK8799	2464F	CK9485	2594F	CK21003
2416	CK9905-C	2577	CK10774-C	2368F	CK5818	2465F	CK2506-2	2596F	CK26008-2
2417	CK9293-C	2580	CK2620-C	2370F	CK8890	2467F COUPLE	CK9666	2599F	CK23011
2418	CK9640-C	2582	CK10657-10-C	2371F	CK8989	2468F	CK9832-2	2600F	CK2347
2419	CK9406-C	2586	CK2030-C	2372F	CK9414	2469F COUPLE	CK9442	2601F	CK23010
2420	CK9396-C	2591	CK27001-C	2373F	CK5942	2470F	CK10073-10	2603F	CK23003
2421	CK9495-C	2592 COUPLE	CK1811-C-2	2374F	CK5863	2472F	CK1827	2604F	CK19004-2
2422	CK5366-C	2593	CK11177-C	2375F	CK8867	2472F	CK9922	2608F	CK27008
2423	CK9323-C	2595	CK2847-C	2376F	CK8714	2473F	CK10431	2612F	CK25008-2
2424	CK9323-C	2597	CK20010-C	2378F	CK8832-2	2474F	CK9686	2618F	CK25007
2426 COUPLE	CK9405-C-2	2603	CK23010-C	2379F COUPLE	CK8799	2475F	CK9881	2622F	CK879
2428	CK9645-C	2605	CK2641-C	2380F	CK8838	2476F	CK9904	2623F	CK26006
2429	CK9364-C	2608	CK19004-C-2	2381F	CK5893	2477F	CK9665	2624F	CK20006
2431	CK5816-C	2613	CK2743-C	2382F	CK5865	2478F	CK22023	2626F	CK22011
2433	CK5664-C	2618	CK25008-C-2	2383F	CK9338	2479F	CK9691	2629F	CK22013
2434	CK9336-C	2622	CK25007-C	2384F	CK8868	2480F	CK9827	2630F	CK25002
2436	CK9408/1-C	2623	CK879-C	2385F	CK8831	2481F	CK10025	2631F	CK26009
2437	CK9294-C	2626	CK20006-C	2386F	CK9077	2487F	CK9594	2633F	CK24003
2446	CK9398-C	2629	CK22011-C	2387F	CK9395	2488F	CK9562	2636F	CK77366480

ASTER	TECNECO
2639F	CK25012
2640F	CK24009
2641F	CK921-2
2643F COUPLE	CK1721-2
2644F	CK26017
2645F	CK26010
2646F	CK26014-C-2
2647F COUPLE	CK26014-2

FIAAM	TECNECO
PC8001	CK5474
PC8002	CK5475
PC8003	CK5551
PC8004	CK5662
PC8005	CK5663
PC8006	CK5664
PC8007	CK5665
PC8008	CK5841
PC8009	CK5824
PC8010	CK5816
PC8011	CK5819
PC8012	CK5817
PC8013	CK5823
PC8014	CK5818
PC8015	CK8103
PC8016	CK5842
PC8017	CK5865
PC8018	CK5864
PC8019	CK5845
PC8020	CK5846
PC8021	CK5847
PC8022	CK5848
PC8023	CK9545
PC8024	CK5850
PC8025	CK5851
PC8026	CK5852-3
PC8028	CK5863
PC8030	CK5893
PC8031	CK5935
PC8032	CK5942
PC8033	CK5972-2
PC8034	CK5990
PC8035	CK8777
PC8038	CK8799
PC8041	CK8832-2
PC8043	CK8831
PC8044	CK9077
PC8046	CK8867
PC8047	CK8868
PC8049	CK8750
PC8050	CK8714
PC8051	CK8890
PC8052	CK8914-2
PC8053	CK8913
PC8054	CK8912-2
PC8055	CK8947-3
PC8056	CK8947-3
PC8058	CK9051
PC8059	CK8838
PC8060	CK9071
PC8061	CK9546
PC8075	CK9293
PC8076	CK9294
PC8077	CK9323
PC8079	CK9335
PC8080	CK9338

FIAAM	TECNECO
PC8081	CK9337
PC8082	CK9336
PC8083	CK9363
PC8084	CK9364
PC8085	CK9396
PC8086	CK9394
PC8087	CK9395
PC8088	CK9398
PC8089	CK9399
PC8091	CK9406
PC8093	CK9408
PC8094	CK9414
PC8096	CK9466
PC8097	CK9495
PC8098	CK9485
PC8099	CK5664
PC8100	CK9533
PC8101	CK9495
PC8102	CK9545
PC8107	CK9579
PC8108	CK9586
PC8110	CK9562
PC8111	CK9442
PC8112	CK9595
PC8113	CK9594
PC8115	CK9383
PC8117	CK9645
PC8124	CK9666
PC8125	CK9659
PC8126	CK9686
PC8127	CK8719
PC8128	CK9691
PC8129	CK9640
PC8130	CK9724
PC8131	CK9740-2
PC8132	CK9742
PC8139	CK9787
PC8141	CK9756
PC8142	CK9827
PC8143-2	CK421-2
PC8144	CK9846
PC8145-2	CK9832-2
PC8147	CK9905
PC8148	CK8989
PC8150	CK9907
PC8151	CK9904
PC8152	CK9882
PC8154	CK9934
PC8155	CK9922
PC8158	CK9881
PC8159	CK10025
PC8161	CK10059
PC8164	CK10067
PC8166	CK10062
PC8170	CK2243
PC8174	CK200
PC8186	CK1919
PC8187	CK2336
PC8197	CK2733
PC8199	CK10436-10
PC8200	CK10413-10
PC8201	CK10431
PC8202	CK10411-10
PC8209	CK10457
PC8212	CK9665
PC8217-2	CK10534-2

FIAAM	TECNECO
PC8228	CK2620-C
PC8230	CK3540
PC8238	CK8717
PC8241	CK10205-2
PC8241-2	CK10205-2
PC8243	CK207
PC8248	CK1910
PC8254	CK28004
PC8255	CK10774
PC8256	CK19001
PC8257	CK17001
PC8258-2	CK26008-2
PC8264	CK1629
PC8265	CK2622
PC8269-2	CK29002-2
PC8291	CK23010
PC8293-2	CK2533-2
PC8294	CK2632-2
PC8296	CK21003
PC8298	CK23011
PC8302	CK2434
PC8305	CK2330
PC8308	CK2138
PC8322	CK20010
PC8326	CK11177
PC8329	CK24004
PC8330	CK2331
PC8331	CK27008
PC8334	CK2516
PC8335	CK2227
PC8339	CK26006
PC8340	CK20006
PC8341-2	CK19004-2
PC8345-2	CK2506-2
PC8346	CK22013
PC8348	CK9922
PC8350	CK321
PC8351-2	CK2542-2
PC8355	CK25012
PC8362-2	CK25008-2
PC8364	CK25007
PC8365	CK77366480
PC8367	CK23003
PC8369	CK224
PC8370	CK22004
PC8374	CK22011
PC8376	CK26017
PC8379	CK25002
PC8382	CK11743
PC8385-2	CK921-2
PC8394	CK3435
PC8396-2	CK26014-2
PC8397	CK24009
PC8418	CK25003
PC8420	CK22023
PC8020	CK5846-C
PCK8036	CK5851-C
PCK8043	CK8831-C
PCK8045	CK8869-C
PCK8047	CK8868-C
PCK8050	CK8714-C
PCK8053	CK8913-C
PCK8054	CK8912-C-2
PCK8062	CK5942-C
PCK8063	CK5664-C
PCK8064	CK5475-C

FIAAM	TECNECO
PCK8066	CK5850-C
PCK8067	CK5863-C
PCK8068	CK5819-C
PCK8069	CK5665-C
PCK8070	CK5823-C
PCK8071	CK5662-C
PCK8072	CK5663-C
PCK8073	CK5816-C
PCK8076	CK9294-C
PCK8078	CK9322-C-2
PCK8084	CK9364-C
PCK8090	CK9405-C-2
PCK8092	CK26010-C
PCK8092	CK9323-C
PCK8093	CK9408-C
PCK8095	CK9445-C
PCK8097	CK9495-C
PCK8099	CK5664-C
PCK8100	CK9533-C
PCK8103	CK9645-C
PCK8104	CK5816-C
PCK8109	CK9398-C
PCK8110	CK9562-C
PCK8122	CK5817-C
PCK8123	CK9665-C
PCK8124	CK9666-C
PCK8137	CK9785-C
PCK8142	CK9827-C
PCK8151	CK9904-C
PCK8153	CK9920-C
PCK8155	CK9922-C
PCK8156	CK9930-C
PCK8157	CK9293-C
PCK8158	CK9881-C
PCK8160	CK8717-C
PCK8162	CK10055-C
PCK8164	CK10067-C
PCK8168-2	CK3139-C-2
PCK8172	CK8430-C
PCK8173-2	CK10205-C-2
PCK8175	CK200-C
PCK8190	CK9586-C
PCK8193	CK10366-10-C
PCK8194	CK2243-C
PCK8199	CK10436-10-C
PCK8201	CK10431-C
PCK8203	CK2747-C
PCK8204-2	CK10536-10-C-2
PCK8208-2	CK10474-C-2
PCK8210	CK10457-C
PCK8214	CK10059-C
PCK8216	CK10529-C
PCK8227	CK619-C
PCK8249	CK10657-10-C
PCK8253	CK27001-C
PCK8255	CK10774-C
PCK8260-2	CK2646-C-2
PCK8262	CK5366-C
PCK8263	CK4436-C
PCK8264	CK1629-C
PCK8265	CK2622-C
PCK8278	CK29005-C
PCK8307-2	CK2941-C-2
PCK8320	CK2743-C
PCK8321	CK2847-C
PCK8332	CK2641-C

FIAAM	TECNECO
PCK8342	CK25001-C
PCK8355	CK25012-C
PCK8360	CK25007-C
PCK8361	CK26009-C
PCK8365	CK77366480-C
PCK8371	CK879-C
PCK8374	CK22011-C
PCK8388	CK2230-C
PCK8396-2	CK26014-C-2

FILTRON	TECNECO
K1000	CK5475
K1000A	CK5475-C
K1001	CK5816
K1001A	CK5816-C
K1002	CK5665
K1002A	CK5665-C
K1004	CK5662
K1004A	CK5662-C
K1006	CK5663
K1006A	CK5663-C
K1007	CK5551
K1008	CK5664
K1009	CK5863
K1009A	CK5863-C
K1010	CK5817
K1010A	CK5817-C
K1011	CK9395
K1013	CK9394
K1014	CK8868
K1014A	CK8868-C
K1015	CK8103
K1016	CK5842
K1016A	CK5842-C
K1017	CK5865
K1018	CK5864
K1019	CK5845
K1020	CK5846
K1020A	CK5846-C
K1021	CK5847
K1022	CK5848
K1023	CK9545
K1024	CK5850
K1024A	CK5850-C
K1025	CK5851
K1026-3X	CK5852-3
K1027	CK8714
K1027A	CK8714-C
K1030	CK5893
K1031	CK5935
K1032	CK5942
K1032A	CK5942-C
K1033	CK5823
K1034	CK5818
K1035	CK5819
K1035A	CK5819-C
K1036	CK5824
K1036A	CK5824-C
K1037	CK9579
K1038	CK8989
K1040-2X	CK8832-2
K1044-2X	CK8914-2
K1045	CK9414
K1045A	CK9414-C
K1046	CK5842
K1047A	CK8869-C

FILTRON	TECNECO	FILTRON	TECNECO	FILTRON	TECNECO	FILTRON	TECNECO	FRAM	TECNECO
K1052	CK8838	K1125	CK9562	K1204A	CK9445-C	K1302	CK23011	CF11743	CK11743
K1053-2X	CK5972-2	K1125A	CK9562-C	K1207	CK207	K1303	CK2227	CF11119	CK1629
K1054	CK8831	K1126	CK9396	K1209	CK321	K1311	CK26009	CFA11119	CK1629-C
K1054A	CK8831-C	K1126A	CK9396-C	K1210	CK1919	K1311A	CK26009-C	CF10823	CK17001
K1055	CK8867	K1127	CK9294	K1210A	CK1919-C	K1312-2X	CK26008-2	CF10526	CK1719
K1056	CK8890	K1128	CK9586	K1212-2X	CK22001-2	K1313	CK26010	CF11532-2	CK1721-2
K1057	CK9742	K1128A	CK9586-C	K1215	CK9880	K1313A	CK26010-C	CF10202	CK1827
K1058	CK9595	K1130	CK9442	K1216A	CK1830-C	K1314	CK2331	CFA10582	CK1830-C
K1059	CK5990	K1130A	CK9442-C	K1217	CK224	K1314	CK24013	CF10776	CK19001
K1060	CK9363	K1131	CK9827	K1217	CK9882	K1316	CK24009	CF11471-2	CK19004-2
K1062-2X	CK8947-3	K1131A	CK9827-C	K1218	CK10087	K1318A	CK2641-C	CFA11471-2	CK19004-C-2
K1063	CK8947-3	K1134-2X	CK9740-2	K1222A-2X	CK9825-C-2	K1321	CK22011	CF10285	CK1919
K1064	CK9724	K1136	CK8913	K1223	CK10774	K1321A	CK22011-C	CF10322	CK1919
K1065	CK8777	K1136A	CK8913-C	K1223A	CK10774-C	K1322	CK20006	CFA10322	CK1919-C
K1065A	CK8777-C	K1137A	CK384-C	K1227-2X	CK10536-10-2	K1324	CK11177	CF10917	CK1936
K1066	CK9071	K1138	CK9904	K1227A-2X	CK10536-10-C-2	K1327A	CK2743-C	CF10200	CK200
K1066A	CK9071-C	K1138A	CK9904-C	K1228	CK10413-10	K1328-2X	CK26014-2	CFA10199	CK200-C
K1067	CK9546	K1140	CK9756	K1230	CK1629	K1328A-2X	CK26014-C-2	CF11470	CK20006
K1071	CK3435	K1143-2X	CK8719	K1231	CK2434	K1330	CK25012	CFA11739	CK20010-C
K1073A-2X	CK9322-C-2	K1145	CK9640	K1232	CK2336	K1331A	CK25001-C	CF11244	CK2028-10
K1075A-2X	CK8912-C-2	K1145A	CK9640-C	K1233	CK2336	K1332	CK24004	CF10080	CK207
K1076A	CK9077-C	K1146	CK9785	K1235A-2X	CK10474-C-2	K1333	CK26006	CF11182	CK21003
K1078	CK9645	K1146A	CK9785-C	K1236	CK1827	K1335	CK77366480	CFA10612	CK2132-C
K1078A	CK9645-C	K1147A	CK9920-C	K1237	CK2733	K1336-2X	CK19004-2	CF11261	CK2138
K1079	CK9323	K1148	CK5664	K1237A	CK2733-C	K1336A-2X	CK19004-C-2	CF10930	CK22004
K1079A	CK9323-C	K1148A	CK5664-C	K1238	CK10366-10	K1338	CK11743	CF11706	CK22011
K1081	CK9495	K1149	CK2356	K1238A	CK10366-10-C	K1340	CK26017	CFA11706	CK22011-C
K1081A	CK9495-C	K1150	CK10059	K1239	CK4436	K1343A	CK24003-C	CF11484	CK22013
K1082	CK9338	K1150A	CK10059-C	K1239A	CK4436-C	K1346A	CK879-C	CF11862	CK22023
K1083	CK9846	K1152	CK9691	K1241	CK10431	K1350	CK25007	CF11444	CK2227
K1087	CK9338	K1154	CK9787	K1245	CK2532-10	K1350A	CK25007-C	CFA11767	CK2230-C
K1088	CK9051	K1154A	CK9787-C	K1246A	CK29005-C	K1353	CK25002	CF11679	CK224
K1088A	CK9051-C	K1155	CK9881	K1247A	CK10529-C	K1355	CK25003	CF10282	CK2243
K1089	CK9364	K1155A	CK9881-C	K1248-2X	CK10534-2	K1357-2X	CK25008-2	CFA10365	CK2243-C
K1089A	CK9364-C	K1156A	CK5819-C	K1250	CK23010			CF11676	CK23003
K1090	CK9335	K1157	CK9399	K1251	CK2436-10			CFA11815-2	CK23005-C-2
K1093	CK9398	K1159A	CK8778-C	K1252	CK2620-C			CF10939	CK23010
K1093A	CK9398-C	K1160-2X	CK3139-2	K1254-2X	CK2632-2			CF11243	CK23011
K1096	CK9337	K1160A-2X	CK3139-C-2	K1255	CK1936			CF10546	CK2330
K1097	CK9293	K1161	CK9665	K1256	CK2952			CF11434	CK2331
K1101	CK9408	K1161A	CK9665-C	K1257-2X	CK29002-2			CF10210	CK2336
K1102	CK9406	K1162-2X	CK10209-2	K1258	CK2012			CF11152	CK2347
K1102A	CK9406-C	K1162A-2X	CK10209-C-2	K1261	CK2544			CF10329	CK2356
K1103	CK9533	K1164	CK10073-10	K1263	CK19001			CF10889	CK24004
K1103A	CK9533-C	K1165-2X	CK3124-10-2	K1264	CK2138			CF11811	CK24009
K1104A	CK9408-C	K1165A-2X	CK3124-10-C-2	K1265	CK5366			CF10248	CK2434
K1105A-2X	CK9405-C-2	K1166	CK1719	K1265A	CK5366-C			CF10659	CK2436-10
K1106	CK9905	K1167	CK10067	K1266	CK2622			CFA11472	CK25001-C
K1106A	CK9905-C	K1169	CK8430	K1267A	CK27001-C			CF11719	CK25002
K1107	CK8750	K1169A	CK8430-C	K1269A	CK2847-C			CF11854	CK25003
K1108	CK9383	K1172	CK2243	K1270-2X	CK2941-2			CF11661	CK25007
K1110	CK9666	K1172A	CK2243-C	K1270A-2X	CK2941-C-2			CFA11642	CK25007-C
K1110A	CK9666-C	K1174	CK2516	K1273A	CK2230-C			CF11644-2	CK25008-2
K1111	CK9922	K1175	CK10411-10	K1274	CK20010			CF11544	CK25012
K1111A	CK9922-C	K1176	CK2504	K1276A	CK2132-C			CFA11544	CK25012-C
K1113	CK9485	K1177	CK9659	K1278	CK10457			CF10245	CK2506-2
K1115	CK9336	K1178	CK2330	K1281	CK22004			CF10923	CK2516
K1115A	CK9336-C	K1179-2X	CK10205-2	K1283	CK28004			CF10471	CK2532-10
K1116A	CK5851-C	K1179A-2X	CK10205-C-2	K1287	CK1910			CF11220-2	CK2533-2
K1117	CK8714	K1181	CK22023	K1288	CK10436-10			CF11506-2	CK2542-2
K1117A	CK8714-C	K1183	CK9466	K1288A	CK10436-10-C			CF10420	CK2544
K1119	CK9594	K1187	CK10062	K1290	CK2028-10			CF11464	CK26006
K1119A	CK9594-C	K1188	CK3540	K1292	CK2347			CF10824-2	CK26008-2
K1120A	CK8717-C	K1189	CK200	K1296A	CK2747-C			CFA11643	CK26009-C
K1121	CK9934	K1198-2X	CK421-2	K1298	CK21003			CF9323	CK26010
K1122	CK10025	K1200A2X	CK2646-C-2	K1300A	CK10657-10-C			CFA9404	CK26010-C

CORRISPONDENZE / CROSS REFERENCES

FRAM	TECNECO	FRAM	TECNECO	FRAM	TECNECO	FRAM	TECNECO	MAHLE/KNECHT	TECNECO
CFA11808-2	CK26014-C-2	CFA8879	CK5863-C	CF9395	CK9395	CF9934	CK9934	LA25	CK5664
CF11178	CK26017	CF5864	CK5864	CF9396	CK9396			LA252	CK10055
CF11166	CK2622	CF5865	CK5865	CF11164	CK9398			LA26	CK5845
CFA11166	CK2622-C	CF5893	CK5893	CF9398	CK9398			LA265	CK9399
CF10553	CK2632-2	CFA5893	CK5893-C	CFA9587	CK9398-C			LA269	CK9659
CFA11436	CK2641-C	CF5935	CK5935	CF9399	CK9399			LA288	CK8719
CFA10828-2	CK2646-C-2	CF5942	CK5942	CFA9405	CK9405-C-2			LA289	CK2632-2
CFA10761	CK27001-C	CFA8876	CK5942-C	CFA9405-2	CK9405-C-2			LA291	CK9394
CF11183	CK27008	CF5972	CK5972-2	CF9406	CK9406			LA293	CK10059
CF10442	CK2733	CF5990	CK5990	CFA9406	CK9406-C			LA297	CK200
CFA10435	CK2733-C	CFA10613	CK619-C	CF9408	CK9408			LA298	CK2434
CFA11285	CK2743-C	CF11662	CK77366480	CFA9408	CK9408-C			LA301	CK2336
CFA10417	CK2747-C	CFA11662	CK77366480-C	CF9414	CK9414			LA304	CK207
CF10763	CK28004	CF8103	CK8103	CF9442	CK9442			LA306	CK2243
CFA11429	CK2847-C	CF10207	CK8430	CFA9442	CK9442-C			LA307	CK10436-10
CF10933-2	CK29002-2	CFA10206	CK8430-C	CFA9445	CK9445-C			LA31	CK5663
CFA10934	CK29005-C	CF5853	CK8714	CF9466	CK9466			LA32/2	CK5846
CFA10920-2	CK2941-C-2	CF8714	CK8714	CF9485	CK9485			LA32/3	CK5846
CF10597	CK2952	CFA8714	CK8714-C	CF9495	CK9495			LA33	CK9545
CFA10103-2	CK3139-C-2	CF8717	CK8717	CF9531	CK9495			LA34	CK5823
CF10893	CK321	CFA8717	CK8717-C	CFA9495	CK9495-C			LA344	CK10411-10
CF11785	CK3435	CF8719	CK8719	CF9533	CK9533			LA346/S	CK22001-2
CF10621	CK3540	CF8750	CK8750	CFA9533	CK9533-C			LA35	CK5818
CF9819-2	CK421-2	CF8777	CK8777	CF9545	CK9545			LA36	CK5816
CF10831	CK4436	CFA11430	CK879-C	CF9546	CK9546			LA360	CK10087
CFA10831	CK4436-C	CF8799	CK8799	CF9562	CK9562			LA361	CK2330
CFA10830	CK5366-C	CF8831	CK8831	CFA9562	CK9562-C			LA362	CK1719
CF5474	CK5474	CFA8831	CK8831-C	CF9579	CK9579			LA37	CK5842
CF5475	CK5475	CF8832	CK8832-2	CF9586	CK9586			LA371	CK9882
CFA8875	CK5475-C	CF8838	CK8838	CFA10307	CK9586-C			LA376	CK9880
CF5551	CK5551	CFA8838	CK8838-C	CF9594	CK9594			LA377S	CK9832-2
CF5662	CK5662	CF8867	CK8867	CF9595	CK9595			LA38	CK3435
CFA8882	CK5662-C	CFA8867	CK8867-C	CF9640	CK9640			LA382	CK9934
CF5663	CK5663	CF8868	CK8868	CF9645	CK9645			LA385	CK4436
CFA8893	CK5663-C	CFA8868	CK8868-C	CFA9548	CK9645-C			LA387	CK2733
CF5664	CK5664	CFA8869	CK8869-C	CF9659	CK9659			LA39	CK9546
CF9534	CK5664	CF8890	CK8890	CF10501	CK9665			LA395	CK1919
CFA8046	CK5664-C	CF8912	CK8912-2	CFA9665	CK9665-C			LA396	CK9136
CFA9534	CK5664-C	CFA8912	CK8912-C-2	CF9666	CK9666			LA40	CK8799
CF5665	CK5665	CFA8912-2	CK8912-C-2	CFA9666	CK9666-C			LA404	CK2516
CFA8880	CK5665-C	CF8913	CK8913	CF9686	CK9686			LA408	CK2138
CF5816	CK5816	CFA8913	CK8913-C	CF9691	CK9691			LA410	CK10366-10
CFA8874	CK5816-C	CF8914	CK8914-2	CF9724	CK9724			LA411	CK2544
CF5817	CK5817	CF8947	CK8947-3	CF9740	CK9740-2			LA412	CK10366-10
CFA9623	CK5817-C	CF8948	CK8947-3	CF9742	CK9742			LA421	CK2622
CF5818	CK5818	CF8989	CK8989	CF9756	CK9756			LA424	CK10431
CF5819	CK5819	CF9051	CK9051	CFA9785	CK9785-C			LA425	CK2336
CFA8894	CK5819-C	CF9071	CK9071	CF9787	CK9787			LA428/S	CK10536-10-2
CF5823	CK5823	CFA9071	CK9071-C	CFA10584	CK9787-C			LA439	CK2952
CFA8881	CK5823-C	CF9077	CK9077	CFA9825-2	CK9825-C-2			LA44	CK9414
CF5824	CK5824	CF11745-2	CK921-2	CF9827	CK9827			LA440	CK2356
CF5841	CK5841	CF9293	CK9293	CFA9827	CK9827-C			LA441	CK2532-10
CF5842	CK5842	CFA9931	CK9293-C	CF9832-2	CK9832-2			LA449	CK2028-10
CFA8877	CK5842-C	CF9294	CK9294	CF9846	CK9846			LA45	CK5662
CF5845	CK5845	CFA9294	CK9294-C	CF9880	CK9880			LA452	CK224
CF5846	CK5846	CFA9322	CK9322-C-2	CF9881	CK9881			LA456	CK22023
CFA5846	CK5846-C	CF9323	CK9323	CFA9881	CK9881-C			LA457	CK10413-10
CF5847	CK5847	CFA9404	CK9323-C	CF9882	CK9882			LA46	CK5942
CF5848	CK5848	CF9335	CK9335	CF9904	CK9904			LA460	CK23003
CFA5848	CK5848-C	CF9336	CK9336	CFA9904	CK9904-C			LA461	CK22004
CF5850	CK5850	CF9337	CK9337	CF9905	CK9905			LA462	CK21003
CFA8878	CK5850-C	CF9338	CK9338	CF9907	CK9907			LA463	CK2436-10
CF5851	CK5851	CF9363	CK9363	CFA9920	CK9920-C			LA464	CK24004
CFA8788	CK5851-C	CF9364	CK9364	CF11486	CK9922			LA467/S	CK2533-2
CF5852	CK5852-3	CFA9364	CK9364-C	CF9922	CK9922			LA468/S	CK10534-2
CF5863	CK5863	CF9383	CK9383	CFA9921	CK9922-C			LA47/S	CK5972-2

MAHLE/KNECHT TECNECO		MAHLE/KNECHT TECNECO		MAHLE/KNECHT TECNECO		MANN TECNECO		MANN TECNECO	
LA472	CK10774	LAK127	CK9562-C	LAK49	CK5863-C	CU2035	CK9686	CU2454	CK10411-10
LA475	CK28004	LAK129	CK9905-C	LAK490	CK1919-C	CU2038	CK5990	CU25002	CK25002
LA477	CK9846	LAK136	CK9364-C	LAK52	CK5850-C	CU2040	CK10413-10	CU25003	CK25003
LA48	CK9742	LAK138	CK9398-C	LAK54	CK9396-C	CU2043	CK9665	CU25007	CK25007
LA482	CK2331	LAK141	CK9405-C-2	LAK56	CK5819-C	CU21000-2	CK10205-2	CU25008-2	CK25008-2
LA49	CK5863	LAK142	CK9533-C	LAK589	CK2230-C	CU21001-2	CK9740-2	CU25012	CK25012
LA495	CK29002-2	LAK145	CK9930-C	LAK59	CK5846-C	CU21003	CK21003	CU2504	CK2504
LA500 EX	CK17001	LAK153	CK9406-C	LAK62	CK5366-C	CU2131	CK9846	CU2506-2	CK2506-2
LA501S	CK26008-2	LAK158	CK9665-C	LAK63	CK8869-C	CU2137	CK9336	CU2516	CK2516
LA52	CK5850	LAK167	CK9586-C	LAK630/S	CK19004-C-2	CU2138	CK2138	CU2520	CK9338
LA53/S	CK1930-2	LAK169	CK9666-C	LAK64	CK5851	CU2141	CK10431	CU2525	CK5848
LA531	CK19001	LAK171	CK9594-C	LAK667	CK2641-C	CU2143	CK9904	CU2530	CK9337
LA54	CK9396	LAK173	CK3124-10-C-2	LAK684	CK10657-10-C	CU2145	CK22023	CU2531	CK5847
LA56	CK5819	LAK173/S	CK3124-10-C-2	LAK686	CK27001-C	CU2149	CK9364	CU2532	CK2532-10
LA569	CK2227	LAK175	CK9442-C	LAK70	CK384-C	CU22001-2	CK22001-2	CU2533-2	CK2533-2
LA57	CK9071	LAK181	CK9922-C	LAK73/S	CK8912-C-2	CU22003	CK224	CU2542-2	CK2542-2
LA58	CK5824	LAK182	CK9881-C	LAK74	CK8867-C	CU22004	CK22004	CU2544	CK2544
LA586	CK17001	LAK184	CK9294-C	LAK75	CK8868-C	CU22011	CK22011	CU2545	CK9323
LA587	CK23010	LAK189	CK9904-C	LAK77	CK5817-C	CU22013	CK22013	CU2559	CK9787
LA60	CK8799	LAK191/S	CK10205-C-2	LAK78	CK8831-C	CU22022	CK77366480	CU26006	CK26006
LA62	CK5366	LAK196	CK9827-C	LAK79	CK8714-C	CU22023	CK22023	CU26008-2	CK26008-2
LA624	CK2012	LAK197/S	CK3139-C-2	LAK809	CK26010-C	CU2224-2	CK8914-2	CU26009	CK26009
LA630/S	CK19004-2	LAK21	CK5665-C	LAK81	CK8777-C	CU2225	CK5551	CU26010	CK26010
LA630S	CK19004-2	LAK220	CK9787-C	LAK812	CK25001-C	CU2227	CK2227	CU26014-2	CK26014-2
LA635	CK23011	LAK221	CK2941-C-2	LAK814	CK2743-C	CU2232	CK200	CU26017	CK26017
LA65	CK9579	LAK221/S	CK2941-C-2	LAK83	CK9051-C	CU2240	CK9293	CU2622	CK2622
LA674/S	CK1811-2	LAK227	CK10067-C	LAK855	CK2847-C	CU2243	CK2243	CU2623	CK2632-2
LA74	CK8867	LAK229	CK3540-C	LAK859	CK22013-C	CU2245	CK9294	CU2629	CK321
LA75	CK8868	LAK232	CK9920-C	LAK87	CK8838-C	CU2252	CK9882	CU2630	CK8750
LA76/S	CK8832-2	LAK239 EX	CK10209-C-2	LAK875	CK25007-C	CU2253	CK5865	CU2631	CK2532-10
LA77	CK5817	LAK239/S	CK10209-C-2	LAK879	CK879-C	CU23003	CK23003	CU2642	CK9595
LA78	CK8831	LAK242	CK5664-C	LAK888	CK26009-C	CU23009	CK2347	CU2645	CK9394
LA79	CK8714	LAK243	CK9640-C	LAK93	CK9645-C	CU23010	CK23010	CU2647	CK9756
LA8	CK5551	LAK248	CK8430-C	LAK96	CK9445-C	CU23011	CK23011	CU2650	CK8714
LA80	CK8103	LAK25	CK5664-C	LAK98	CK8717-C	CU2316	CK9442	CU2672	CK9414
LA809	CK26010	LAK250	CK619-C	LAK116/S	CK9825-C-2	CU2317	CK207	CU2680	CK9406
LA811	CK26006	LAK251	CK1830-C			CU2326	CK9335	CU27008	CK27008
LA813	CK2347	LAK252	CK10055-C			CU2327	CK421-2	CU2733	CK2733
LA82	CK5865	LAK280	CK2747-C			CU2327-2	CK421-2	CU2734	CK8799
LA83	CK9051	LAK293	CK10059-C			CU2330	CK2330	CU2736-2	CK8912-2
LA84	CK9338	LAK295/S	CK2646-C-2			CU2331	CK2331	CU2745-2	CK5972-2
LA859	CK22013	LAK297	CK200-C			CU2335	CK9408	CU2757	CK8867
LA86/S	CK5852-3	LAK307	CK10436-10-C			CU2336	CK2336	CU28004	CK28004
LA87	CK8838	LAK31	CK5663-C			CU2337	CK9395	CU2835	CK8103
LA873S	CK1721-2	LAK32/1	CK5846-C			CU2338	CK8717	CU2839	CK9399
LA875	CK25007	LAK345	CK22023			CU2344	CK8989	CU2842	CK9881
LA876	CK26017	LAK36	CK5816-C			CU2345	CK9363	CU2855	CK9396
LA877	CK25002	LAK37	CK5842-C			CU2351	CK9338	CU2861	CK5864
LA888	CK26009	LAK373	CK2243-C			CU2356	CK2356	CU2882	CK5663
LA889	CK77366480	LAK385	CK4436-C			CU2358	CK10062	CU2897	CK5842
LA891	CK25012	LAK386	CK10457-C			CU24004	CK24004	CU29002-2	CK29002-2
LA9	CK5864	LAK387	CK2733-C			CU24009	CK24009	CU29003-2	CK10536-10-2
LA912S	CK25008-2	LAK410	CK10366-10-C			CU24012-2	CK921-2	CU29007	CK11743
LA921S	CK921-2	LAK412	CK10366-10-C			CU24013	CK24013	CU2930	CK9546
LA922	CK20006	LAK413	CK29005-C			CU2418-2	CK10534-2	CU2939	CK9922
LA923	CK22011	LAK426/S	CK10474-C-2			CU2422	CK9533	CU2940	CK9398
LA93	CK9645	LAK428	CK10536-10-C-2			CU2423	CK10087	CU2941-2	CK2941-2
LA947	CK11743	LAK428S	CK10536-10-C-2			CU2424	CK5893	CU2945	CK8838
LA97	CK9077	LAK430	CK2132-C			CU2430	CK10067	CU2951	CK5819
LA98	CK8717	LAK437	CK10529-C			CU2431	CK9335	CU2952	CK2952
LAK102	CK8913-C	LAK44	CK9414-C			CU2433	CK9666	CU2956	CK5819
LAK107	CK9336-C	LAK447	CK2331-C			CU2434	CK2434	CU3020	CK9077
LAK11	CK5475-C	LAK45	CK5662-C			CU2435	CK8799	CU3023-2	CK10209-2
LAK117	CK9495-C	LAK454	CK2030-C			CU2436	CK2436-10	CU3032	CK9545
LAK120	CK9323-C	LAK46	CK5942-C			CU2440	CK10059	CU3037	CK9645
LAK122	CK421-C-2	LAK469	CK2620-C			CU2442	CK10774	CU3039-2	CK10536-10-2

MANN	TECNECO	MANN	TECNECO	MANN	TECNECO	MICRONAIR	TECNECO	MICRONAIR	TECNECO
CU3054	CK8868	CUK2141	CK10431-C	CUK3023-2	CK10209-C-2	MC550	CK5823-C	MC771	CK10457-C
CU3059	CK5816	CUK2143	CK9904-C	CUK3037	CK9645-C	MC555	CK5846-C	MC772	CK2138-C
CU3080	CK9907	CUK2145	CK22023	CUK3039-2	CK10536-10-C-2	MC557	CK9071-C	MC773	CK1919-C
CU3124-2	CK3124-10-2	CUK2149	CK9364-C	CUK3042	CK5851-C	MC559	CK9905-C	MC784	CK9398-C
CU3136	CK5841	CUK22011	CK22011-C	CUK3054	CK8868-C	MC560	CK9323-C	MC785	CK2622-C
CU3138	CK5818	CUK22013	CK22013-C	CUK3059	CK5816-C	MC561	CK9406-C	MC787	CK4436-C
CU3139	CK3139-2	CUK22021	CK22021-C	CUK3124-2	CK3124-10-C-2	MC564	CK9364-C	MC800	CK10366-10-C
CU3139-2	CK3139-2	CUK22022	CK77366480-C	CUK3139	CK3139-C-2	MC566-2	CK421-C-2	MC808	CK2733
CU3172	CK9785	CUK2227	CK2227-C	CUK3139-2	CK3139-C-2	MC571	CK9398-C	MC816	CK2132-C
CU3192	CK5942	CUK2230	CK2230-C	CUK3172	CK9785-C	MC576	CK5664-C	MC825	CK2227-C
CU3337	CK9495	CUK2232	CK200-C	CUK3192	CK5942-C	MC578	CK9408-C	MC836-2	CK10474-C-2
CU3338	CK5935	CUK2243	CK2243-C	CUK3220	CK8778-C	MC589	CK9414-C	MC848	CK2030-C
CU3340	CK5846	CUK2252	CK9882-C	CUK3240	CK9920-C	MC590	CK9445-C	MC855	CK2230-C
CU3360	CK5846	CUK23005-2	CK23005-C-2	CUK3241	CK9930-C	MC591	CK5851-C	MC866	CK10774-C
CU3435	CK3435	CUK2327-2	CK421-C-2	CUK3337	CK9495-C	MC592	CK8869-C	MC867	CK10529-C
CU3448	CK9071	CUK2335	CK9408-C	CUK3340	CK5846-C	MC593-2	CK9322-2	MC878	CK2620-C
CU3454	CK9934	CUK2338	CK8717-C	CUK3360	CK5846-C	MC594	CK8717-C	MC900	CK26010-C
CU3455	CK5665	CUK24003	CK24003-C	CUK3448	CK9071-C	MC595-2	CK9405-C-2	MC907	CK27001-C
CU3461	CK9905	CUK2422	CK9533-C	CUK3455	CK5665-C	MC596	CK9533-C	MC908	CK2641-C
CU3518	CK9562	CUK2424	CK5893-C	CUK3461	CK9905-C	MC597	CK5664-C	MC913	CK1629-C
CU3540	CK3540	CUK2430	CK10067-C	CUK3518	CK9562-C	MC598	CK9930-C	MC917	CK2847-C
CU3554	CK5817	CUK2433	CK9666-C	CUK3540	CK3540-C	MC606	CK9645-C	MC918	CK2743-C
CU3562	CK5824	CUK2440	CK10059-C	CUK3554	CK5817-C	MC607	CK9495-C	MC922	CK19004-C-2
CU3567	CK8831	CUK2442	CK10774-C	CUK3567	CK8831-C	MC609	CK9785-C	MC925	CK22013-C
CU3569	CK10436-10	CUK2450	CK10457-C	CUK3569	CK10436-10-C	MC611-2	CK3124-10-C-2	MC927	CK25012-C
CU3642-2	CK9322-2	CUK25001	CK25001-C	CUK3642-2	CK9322-C-2	MC613	CK9922-C	MC930	CK25001-C
CU3649	CK9485	CUK25007	CK25007-C	CUK3780	CK8777-C	MC614	CK9666-C	MC937	CK26009-C
CU3759	CK9383	CUK25012	CK25012-C	CUK3840	CK9827-C	MC615	CK9827-C	MP002	CK5935
CU3780	CK8777	CUK2525	CK5848-C	CUK3847	CK10366-10-C	MC616	CK9586-C	MP003	CK8103
CU3840	CK9827	CUK2545	CK9323-C	CUK3858	CK9051-C	MC619	CK619-C	MP005	CK5842
CU3847	CK10366-10	CUK2559	CK9787-C	CUK3943	CK9640-C	MC630	CK9594-C	MP006-3	CK5852-3
CU3858	CK9051	CUK26003	CK619-C	CUK3955	CK5662-C	MC639	CK9904-C	MP009	CK5475
CU3942	CK5823	CUK26005	CK10657-10-C	CUK4054	CK10055-C	MC640	CK9920-C	MP011	CK5662
CU3943	CK9640	CUK26007	CK879-C	CUK4151	CK5863-C	MC641	CK9881-C	MP012	CK5864
CU3955	CK5662	CUK26009	CK26009-C	CUK4179	CK9586-C	MC642	CK9787-C	MP013	CK8890
CU4054	CK10055	CUK26010	CK26010-C	CUK4251	CK5475-C	MC645	CK10059-C	MP014	CK8868
CU4151	CK5863	CUK26014-2	CK26014-C-2	CUK4436	CK4436-C	MC646	CK9396-C	MP015	CK5816
CU4179	CK9586	CUK26017	CK26017-C	CUK4624	CK9594-C	MC647	CK9665-C	MP016	CK5851
CU4251	CK5475	CUK2620	CK2620-C	CUK5141	CK5664-C	MC648	CK3540-C	MP017	CK5817
CU4260	CK5845	CUK2639	CK10657-10-C	CUK5257	CK5664-C	MC649	CK5366-C	MP018	CK5665
CU4416	CK9724	CUK2641	CK2641-C	CUK5258	CK384-C	MC659	CK384-C	MP020	CK9051
CU4436	CK4436	CUK2646-2	CK2646-C-2	CUK5366	CK5366-C	MC661	CK10055-C	MP021	CK5818
CU4442	CK8890	CUK2672	CK9414-C	CUK5480	CK5850-C	MC663	CK10025-C	MP022-2	CK5972-2
CU4624	CK9594	CUK2680	CK9406-C	CUK6724	CK8913-C	MC665	CK9323-C	MP023	CK9383
CU5141	CK5664	CUK27001	CK27001-C	CUK8430	CK8430-C	MC666-2	CK3139-C-2	MP024	CK9579
CU5257	CK5664	CUK2723-2	CK10474-C-2			MC667	CK9442-C	MP025	CK5850
CU5366	CK5366	CUK2733	CK2733-C			MC670	CK1830-C	MP027	CK5841
CU5480	CK5850	CUK2736-2	CK8912-C-2			MC673	CK9294-C	MP029	CK5865
CU6724	CK8913	CUK2742	CK10529-C			MC676	CK2747-C	MP030-2	CK8912-2
CU8430	CK8430	CUK2743	CK2743-C			MC677	CK10436-10-C	MP031	CK9414
CUK1611	CK1611-C	CUK2747	CK2747-C			MC681	CK10059-C	MP032	CK5863
CUK1629	CK1629-C	CUK2757	CK8867-C			MC685	CK10209-C-2	MP033	CK8838
CUK1820-2	CK9405-C-2	CUK2842	CK9881-C			MC688	CK9562-C	MP034	CK5551
CUK1830	CK1830-C	CUK2847	CK2847-C			MC689	CK8778-C	MP035	CK5847
CUK19004	CK19004-C-2	CUK2855	CK9396-C			MC693	CK2243-C	MP037	CK8777
EX	CK19004-C-2	CUK2862	CK8869-C			MC694	CK9495-C	MP038	CK8913
CUK1919	CK1919-C	CUK2882	CK5663-C			MC695	CK8430-C	MP039	CK5819
CUK20000-2	CK9825-C-2	CUK2897	CK5842-C			MC699	CK1611-C	MP041	CK8831
CUK20006	CK20006-C	CUK29003-2	CK10536-10-C-2			MC700	CK200-C	MP042	CK9395
CUK20010	CK20010-C	CUK29005	CK29005-C			MC701-2	CK10536-10-C-2	MP043	CK9394
CUK2026	CK10025-C	CUK2939	CK9922-C			MC70-12	CK10536-10-C-2	MP044	CK5663
CUK2030	CK2030-C	CUK2940	CK9398-C			MC702	CK10411-10-C	MP047	CK8867
CUK2032	CK9445-C	CUK2941-2	CK2941-C-2			MC725	CK22023	MP048	CK5824
CUK2043	CK9665-C	CUK2945	CK8838-C			MC738-2	CK2646-C-2	MP049	CK5942
CUK21000-2	CK10205-C-2	CUK2951	CK5819-C			MC747	CK10431-C	MP050	CK5823
CUK2132	CK2132-C	CUK2956	CK5819-C			MC751	CK3435-C	MP051	CK5848

MICRONAIR	TECNECO	MICRONAIR	TECNECO	MICRONAIR	TECNECO	PURFLUX	TECNECO	PURFLUX	TECNECO
MP054	CK5845	MP181	CK10059	MP421	CK26006	AH167	CK8831	AH286	CK10774
MP055	CK5846	MP185	CK10209-2	MP424-2	CK26008-2	AH169	CK9293	AH287	CK19001
MP057	CK9071	MP191	CK8989	MP425	CK22013	AH170	CK8868	AH291	CK17001
MP058-2	CK8914-2	MP192	CK2504	MP427	CK25012	AH171	CK8867	AH292	CK26008-2
MP059	CK9905	MP193	CK2243	MP428	CK22011	AH173	CK9396	AH297	CK8717
MP060	CK9323	MP194	CK9495	MP436	CK27008	AH174	CK8989	AH301	CK1910
MP061	CK9406	MP195	CK8430	MP437	CK26009	AH175	CK9335	AH303	CK1827
MP062	CK9595	MP196	CK2336	MP440	CK77366480	AH179	CK9398	AH305	CK1719
MP063	CK9363	MP197	CK2434	MP442	CK11743	AH180	CK8750	AH306	CK1629
MP064	CK9364	MP198	CK1827	MP457-2	CK26014-2	AH182	CK9579	AH307	CK2622
MP065	CK8799	MP200	CK200	MP458-2	CK1721-2	AH184	CK9645	AH330	CK2347
MP066-2	CK421-2	MP201-2	CK10536-10-2			AH185	CK9364	AH332	CK23010
MP068-2	CK8832-2	MP202	CK10411-10			AH186	CK9934	AH336-2	CK2533-2
MP069	CK8714	MP203-2	CK2506-2			AH189	CK9686	AH337	CK2632-2
MP071	CK9398	MP204	CK9756			AH190	CK9533	AH339	CK21003
MP076	CK5664	MP207	CK207			AH191	CK9323	AH340	CK1936
MP077	CK9335	MP213	CK2356			AH192	CK9594	AH341	CK23011
MP078	CK9408	MP220	CK1910			AH193	CK9294	AH345	CK2434
MP079	CK9399	MP223	CK9934			AH194	CK9905	AH347	CK2330
MP080	CK9338	MP224	CK224			AH195	CK9666	AH350	CK2138
MP081	CK9077	MP225	CK22023			AH198	CK9495	AH356	CK11177
MP082	CK9337	MP227-2	CK22001-2			AH199	CK9442	AH359	CK24004
MP084	CK5893	MP232	CK9338			AH201	CK9408	AH360	CK2331
MP085	CK9336	MP233	CK9640			AH202	CK9922	AH361	CK27008
MP086	CK9396	MP234	CK10087			AH203	CK9827	AH364	CK2516
MP087-3	CK8947-3	MP235	CK8719			AH204	CK9363	AH365	CK2227
MP088	CK9293	MP247	CK10431			AH205	CK9586	AH370	CK26006
MP094	CK8717	MP251	CK3435			AH206	CK9904	AH371	CK20006
MP095-2	CK9405-2	MP257	CK28004			AH207	CK9691	AH372-2	CK19004-2
MP096	CK9533	MP262	CK2544			AH209	CK9881	AH375-2	CK2506-2
MP097	CK5664	MP263	CK2952			AH210	CK9846	AH376	CK22013
MP101	CK9485	MP264	CK10205-2			AH212	CK9787	AH381	CK321
MP104	CK9466	MP264-2	CK10205-2			AH214	CK9399	AH383-2	CK2542-2
MP105	CK9846	MP266	CK2632-2			AH220	CK421-2	AH385-2	CK1721-2
MP106	CK9645	MP269	CK2532-10			AH220-2	CK421-2	AH386	CK25012
MP107	CK9495	MP270	CK1936			AH221	CK10062	AH393-2	CK25008-2
MP109	CK9785	MP271	CK10457			AH222	CK10087	AH395	CK25007
MP111-2	CK3124-10-2	MP272	CK2138			AH223	CK207	AH396	CK77366480
MP113	CK9922	MP273	CK1919			AH224	CK9485	AH398	CK23003
MP114	CK9666	MP276-2	CK10534-2			AH225	CK9337	AH400	CK224
MP115	CK9827	MP283	CK10413-10			AH226	CK9395	AH401	CK22004
MP116	CK9586	MP285	CK2622			AH227	CK9640	AH405	CK22011
MP117	CK9686	MP287	CK4436			AH228	CK9724	AH406	CK26017
MP120	CK2330	MP300	CK10366-10			AH230	CK9756	AH409	CK25002
MP125	CK2516	MP304	CK10067			AH231	CK8890	AH412	CK11743
MP128-2	CK9740-2	MP320	CK23010			AH233	CK10025	AH415-2	CK921-2
MP129	CK9659	MP321	CK321			AH234	CK10067	AH423	CK3435
MP130	CK9594	MP325	CK2227			AH238	CK10059	AH425-2	CK26014-2
MP139	CK9904	MP336-2	CK10474-2			AH244	CK2243	AH426	CK24009
MP141	CK9881	MP342	CK1719			AH245	CK10205-2	AH482	CK25003
MP142	CK9787	MP347	CK2331			AH245-2	CK10205-2	AH484	CK22023
MP145	CK10059	MP352	CK2436-10			AH248	CK2336	AHC102	CK5846-C
MP147	CK9665	MP366	CK10774			AH250	CK200	AHC103	CK5664-C
MP148	CK3540	MP367	CK10529			AH256	CK1919	AHC105	CK5665-C
MP149	CK5366	MP368	CK19001			AH257	CK2356	AHC107	CK5819-C
MP157	CK8750	MP370-2	CK10536-10-2			AH261	CK10536-10-2	AHC112	CK8947-3
MP158	CK10073-10	MP380-2	CK2533-2			AH262	CK10431	AHC113	CK8947-3
MP161	CK10055	MP382	CK24013			AH264	CK10474-C-2	AHC117	CK5848-C
MP163	CK10025	MP385	CK21003			AH265	CK10413-10	AHC119	CK5662-C
MP164	CK24004	MP390	CK2347			AH266	CK10411-10	AHC120	CK8103
MP166-2	CK3139-2	MP396-2	CK29002-2			AH267	CK2733	AHC122	CK5817-C
MP167	CK9442	MP399	CK17001			AH271	CK9665	AHC124	CK5863-C
MP172	CK9665	MP400	CK26010			AH273	CK10534-2	AHC126	CK8777-C
MP173	CK9294	MP402-2	CK1811-2			AH273-2	CK10534-2	AHC128	CK5816-C
MP177	CK10436-10	MP405	CK11177			AH274	CK2620-C	AHC129	CK5850-C
MP179	CK9691	MP412	CK20006			AH282	CK2436-10	AHC130	CK5935
MICRONAIR	TECNECO			PURFLUX	TECNECO				
AH101	CK5551			AH101	CK5551				
AH102	CK5846			AH102	CK5846				
AH103	CK5664			AH103	CK5664				
AH104	CK5663			AH104	CK5663				
AH105	CK5665			AH105	CK5665				
AH106	CK5475			AH106	CK5475				
AH107	CK5819			AH107	CK5819				
AH108	CK5818			AH108	CK5818				
AH109	CK5841			AH109	CK5841				
AH110	CK5823			AH110	CK5823				
AH111	CK5851			AH111	CK5851				
AH112	CK8947-3			AH112	CK8947-3				
AH113	CK8947-3			AH113	CK8947-3				
AH114	CK5864			AH114	CK5864				
AH115	CK5845			AH115	CK5845				
AH116	CK9545			AH116	CK9545				
AH117	CK5848			AH117	CK5848				
AH118	CK5847			AH118	CK5847				
AH119	CK5662			AH119	CK5662				
AH120	CK8103			AH120	CK8103				
AH121	CK5823			AH121	CK5823				
AH122	CK5817			AH122	CK5817				
AH123	CK5852-3			AH123	CK5852-3				
AH124	CK5863			AH124	CK5863				
AH125	CK9414			AH125	CK9414				
AH126	CK8777			AH126	CK8777				
AH127	CK5865			AH127	CK5865				
AH128	CK5816			AH128	CK5816				
AH129	CK5850			AH129	CK5850				
AH130	CK5935			AH130	CK5935				
AH132	CK9546			AH132	CK9546				
AH133	CK8799			AH133	CK8799				
AH134	CK8912-2			AH134	CK8912-2				
AH135	CK5990			AH135	CK5990				
AH137	CK5972-2			AH137	CK5972-2				
AH138	CK5842			AH138	CK5842				
AH139	CK5824			AH139	CK5824				
AH140	CK9071			AH140	CK9071				
AH141	CK9742			AH141	CK9742				
AH142	CK9595			AH142	CK9595				
AH143	CK8838			AH143	CK8838				
AH144	CK8799			AH144	CK8799				
AH146	CK9907			AH146	CK9907				
AH147	CK5942			AH147	CK5942				
AH148	CK9880			AH148	CK9880				
AH150	CK5893			AH150	CK5893				
AH151	CK9740-2			AH151	CK9740-2				
AH157	CK8914-2			AH157	CK8914-2				
AH158	CK9051			AH158	CK9051				
AH159	CK9383			AH159	CK9383				
AH160	CK9466			AH160	CK9466				
AH163	CK8832-2			AH163	CK8832-2				
AH166	CK9406			AH166	CK9406				

PURFLUX	TECNECO	PURFLUX	TECNECO	WIX	TECNECO	WIX	TECNECO	WIX	TECNECO
AHC136	CK9414-C	AHC373	CK25001-C	WP6805	CK5665-C	WP6969	CK5851-C	WP9171	CK384-C
AHC138	CK5842-C	AHC386	CK25012-C	WP6808	CK5662-C	WP6976	CK3139-2	WP9174	CK9442
AHC143	CK8838-C	AHC391	CK25007-C	WP6809	CK5662-C	WP6977	CK3139-C-2	WP9175	CK9442-C
AHC147	CK5942-C	AHC392	CK26009-C	WP6812	CK5663	WP6978	CK9383	WP9176	CK9827
AHC149	CK8714-C	AHC396	CK77366480-C	WP6813	CK5663-C	WP6980	CK9337	WP9177	CK9827-C
AHC150	CK5893-C	AHC402	CK879-C	WP6814	CK5551	WP6984	CK9051	WP9178	CK9904
AHC153	CK9077-C	AHC405	CK22011-C	WP6816	CK5664	WP6985	CK9051-C	WP9179	CK9904-C
AHC154	CK9408-C	AHC409	CK20010-C	WP6817	CK5664-C	WP6990	CK9691	WP9181	CK8778-C
AHC156	CK5851-C	AHC418	CK2230-C	WP6818	CK5863	WP6994	CK9338	WP9183	CK9920-C
AHC166	CK9406-C	AHC425-2	CK26014-C-2	WP6819	CK5863-C	WP6998	CK9645	WP9186	CK9665
AHC167	CK8831-C	AHC428-2	CK23005-C-2	WP6820	CK5817	WP6999	CK9645-C	WP9187	CK9665-C
AHC169	CK9293-C	AHC494	CK2747-C	WP6821	CK5817-C	WP9001	CK9408-C	WP9188	CK10209-2
AHC177	CK9405-C-2			WP6822	CK9395	WP9002	CK8913	WP9189	CK10209-C-2
AHC178	CK8869-C			WP6826	CK9394	WP9003	CK8913-C	WP9192	CK9466
AHC179	CK9398-C			WP6828	CK8868	WP9021	CK8717-C	WP9199	CK9825-C-2
AHC181	CK384-C			WP6829	CK8868-C	WP9024	CK9335	WP9200	CK2356
AHC183	CK9562-C			WP6830	CK8103	WP9026	CK9466	WP9204	CK9740-2
AHC184	CK9645-C			WP6832	CK5842	WP9026	CK9846	WP9206	CK421-2
AHC185	CK9364-C			WP6833	CK5842-C	WP9028	CK9640	WP9208	CK9586
AHC187	CK8913-C			WP6834	CK5865	WP9029	CK9640-C	WP9209	CK9586-C
AHC188	CK9445-C			WP6836	CK5864	WP9034	CK9495	WP9210	CK10025
AHC190	CK9533-C			WP6838	CK5845	WP9035	CK9495-C	WP9212	CK10067
AHC191	CK26010-C			WP6840	CK5846	WP9036	CK9323	WP9214	CK5819
AHC191	CK9323-C			WP6841	CK5846-C	WP9037	CK9323-C	WP9215	CK5819-C
AHC192	CK9594-C			WP6842	CK5847	WP9090	CK9336	WP9216	CK10073-10
AHC193	CK9294-C			WP6844	CK5848	WP9091	CK9336-C	WP9222	CK3540
AHC195	CK9666-C			WP6846	CK9545	WP9096	CK9485	WP9224	CK10062
AHC198	CK9495-C			WP6848	CK5850	WP9100	CK9396	WP9226	CK9399
AHC199	CK9442-C			WP6849	CK5850-C	WP9101	CK9396-C	WP9230	CK10059
AHC200	CK9930-C			WP6852	CK5852-3	WP9102	CK9905	WP9231	CK10059-C
AHC202	CK9922-C			WP6860	CK5893	WP9103	CK9905-C	WP9232	CK8430
AHC203	CK9827-C			WP6864	CK5942	WP9104	CK9363	WP9233	CK8430-C
AHC205	CK9586-C			WP6866	CK5823	WP9106	CK9364	WP9236	CK2516
AHC206	CK9904-C			WP6868	CK5818	WP9107	CK9364-C	WP9238	CK1719
AHC208	CK9665-C			WP6870	CK5819	WP9108	CK9338	WP9242	CK2504
AHC209	CK9881-C			WP6871	CK5819-C	WP9110	CK9666	WP9244	CK2506-2
AHC211	CK9785-C			WP6872	CK5824	WP9111	CK9666-C	WP9246	CK9934
AHC213	CK9920-C			WP6874	CK9579	WP9112	CK9398	WP9248	CK9659
AHC234	CK10067-C			WP6876	CK8989	WP9113	CK9398-C	WP9250	CK2243
AHC237	CK10055-C			WP6880	CK8832-2	WP9114	CK9406	WP9251	CK2243-C
AHC239	CK8912-C-2			WP6888	CK8914-2	WP9115	CK9406-C	WP9252	CK10411-10
AHC241	CK2646-C-2			WP6890	CK9414	WP9116	CK9533	WP9254	CK2330
AHC244	CK2243-C			WP6891	CK9414-C	WP9117	CK9533-C	WP9256	CK10205-2
AHC245	CK10205-C-2			WP6895	CK8869-C	WP9118	CK8750	WP9257	CK10205-C-2
AHC246	CK8430-C			WP6898	CK5990	WP9125	CK9405-C-2	WP9260	CK200
AHC247	CK10209-C-2			WP6900	CK5935	WP9128	CK9562	WP9263	CK2646-C-2
AHC250	CK200-C			WP6910	CK9724	WP9129	CK9562-C	WP9267	CK10055-C
AHC258	CK10366-10-C			WP6912	CK8890	WP9130	CK9408	WP9271	CK9445-C
AHC261	CK10536-10-C-2			WP6914	CK8777	WP9134	CK8714	WP9276	CK207
AHC262	CK10431-C			WP6915	CK8777-C	WP9136	CK9686	WP9280	CK321
AHC264-2	CK10474-C-2			WP6918	CK8867	WP9140	CK9594	WP9282	CK22001-2
AHC267	CK2733-C			WP6922	CK9742	WP9141	CK9594-C	WP9290	CK1919
AHC268	CK10436-10-C			WP6924	CK9595	WP9142	CK9294	WP9291	CK1919-C
AHC272	CK10529-C			WP6926	CK9071	WP9144	CK8947-3	WP9293	CK1830-C
AHC273	CK10534-C-2			WP6927	CK9071-C	WP9146	CK9922	WP9294	CK224
AHC281	CK10657-10-C			WP6928	CK8838	WP9147	CK9922-C	WP9294	CK9882
AHC284	CK27001-C			WP6930	CK9546	WP9148	CK9785	WP9296	CK10087
AHC286	CK10774-C			WP6932	CK8799	WP9149	CK9785-C	WP9300	CK2434
AHC300	CK4436-C			WP6934	CK5972-2	WP9160	CK8719	WP9302	CK2336
AHC306	CK1629-C			WP6936	CK8831	WP9162	CK5664	WP9304	CK2336
AHC307	CK2622-C			WP6937	CK8831-C	WP9164	CK9787	WP9307	CK10474-C-2
AHC318	CK29005-C			WP6938	CK9293	WP9165	CK9787-C	WP9308	CK2733
AHC349-2	CK2941-C-2			WP6946	CK3435	WP9166	CK9881	WP9309	CK2733-C
AHC352	CK2743-C			WP6951	CK9322-C-2	WP9167	CK9881-C	WP9310	CK10366-10
AHC353	CK2847-C			WP6955	CK8912-C-2	WP9168	CK3124-10-2	WP9311	CK10366-10-C
AHC362	CK2641-C			WP6957	CK9077-C	WP9169	CK3124-10-C-2	WP9314	CK1827

ZAFFO	TECNECO
522F COUPLE	CK2542-2
524F	CK2632-2
526F	CK2243
528F	CK1919
529F	CK2138
532F	CK2012
537F	CK321
540F	CK10205-2
541F	CK10411-10
542F	CK2544
544F	CK2733
546F	CK2532-10
548F	CK4436
549F	CK2227
550F	CK24004
554F COUPLE	CK10536-10-2
555F	CK10366-10
557F	CK2622
562F	CK2331
564F	CK10457
566F	CK1936
569F	CK22004
570F COUPLE	CK2941-2
572F	CK10413-10
573F	CK2028-10
574F COUPLE	CK10474-2
575F	CK10529
577F	CK10774
579F	CK28004
581F COUPLE	CK10534-2
583F	CK2436-10
584F	CK29002-2
588F	CK17001
589F	CK19001
590F	CK2533-2
592F COUPLE	CK1811-2
593F	CK11177
594F	CK1629
596F	CK21003
597F	CK20010
599F	CK26008-2
600F	CK23011
601F	CK2347
603F	CK23010
604F	CK23003
608F	CK19004-2
612F	CK27008
618F	CK25008-2
622F	CK25007
623F	CK879
624F	CK26006
626F	CK20006
629F	CK22011
630F	CK22013
631F	CK25002
633F	CK26009
636F	CK24003
637F	CK77366480
639F	CK11743
640F	CK25012
641F	CK24009
643F COUPLE	CK921-2
644F	CK1721-2
645F	CK26017
646F	CK26010
647F COUPLE	CK26014-2

CODICI A BARRE
BARCODE

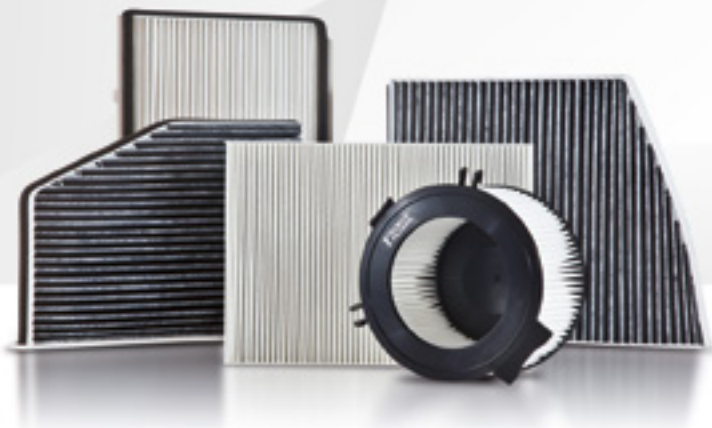

TECNECO	BARCODE	TECNECO	BARCODE	TECNECO	BARCODE	TECNECO	BARCODE
CK10025	80-20325-015093	CK20013	80-20325-022398	CK26014-2	80-20325-020523	CK5842-C	80-20325-013426
CK10025-C	80-20325-017073	CK200-C	80-20325-015338	CK26014-C-2	80-20325-020530	CK5845	80-20325-013402
CK10055	80-20325-016717	CK2012	80-20325-016557	CK26017	80-20325-021483	CK5846	80-20325-015048
CK10055-C	80-20325-015291	CK2028-10	80-20325-017790	CK26017-C	80-20325-021391	CK5846-C	80-20325-015055
CK10059	80-20325-015109	CK2030-C	80-20325-020097	CK2620-C	80-20325-021995	CK5847	80-20325-013419
CK10059-C	80-20325-015116	CK207	80-20325-015130	CK2622	80-20325-018810	CK5848	80-20325-013433
CK10062	80-20325-015543	CK21003	80-20325-021094	CK2622-C	80-20325-018827	CK5848-C	80-20325-013440
CK10067	80-20325-015888	CK21009	80-20325-022404	CK2641-C	80-20325-019114	CK5850	80-20325-013457
CK10067-C	80-20325-016045	CK2132-C	80-20325-017189	CK2646-C-2	80-20325-018230	CK5850-C	80-20325-013464
CK10073-10	80-20325-017479	CK2138	80-20325-020103	CK27001-C	80-20325-020677	CK5851	80-20325-013471
CK10087	80-20325-015123	CK2138-C	80-20325-020639	CK27008	80-20325-020707	CK5851-C	80-20325-013488
CK10205-2	80-20325-016182	CK22001-2	80-20325-015147	CK2733	80-20325-020141	CK5852-3	80-20325-013495
CK10205-C-2	80-20325-016199	CK22004	80-20325-021490	CK2733-C	80-20325-020158	CK5863	80-20325-013501
CK10209-2	80-20325-016205	CK22011	80-20325-020516	CK2743-C	80-20325-020165	CK5863-C	80-20325-013518
CK10209-C-2	80-20325-016212	CK22011-C	80-20325-021049	CK2747-C	80-20325-020172	CK5864	80-20325-013525
CK10366-10	80-20325-018001	CK22013	80-20325-021193	CK28004	80-20325-021629	CK5865	80-20325-013532
CK10366-10-C	80-20325-018018	CK22013-C	80-20325-021216	CK2847-C	80-20325-020981	CK5893	80-20325-013549
CK10411-10	80-20325-018025	CK22021	80-20325-022459	CK29002-2	80-20325-018834	CK5893-C	80-20325-013556
CK10411-10-C	80-20325-018032	CK22021-C	80-20325-021841	CK29002-C-2	80-20325-018841	CK5935	80-20325-013563
CK10413-10	80-20325-017486	CK22023	80-20325-022015	CK29005-C	80-20325-020417	CK5942	80-20325-013570
CK10431	80-20325-018322	CK2227	80-20325-020110	CK2941-2	80-20325-020189	CK5942-C	80-20325-013587
CK10431-C	80-20325-018339	CK2227-C	80-20325-020653	CK2941-C-2	80-20325-020196	CK5972-2	80-20325-013594
CK10436-10	80-20325-017493	CK2230-C	80-20325-016564	CK2952	80-20325-017271	CK5990	80-20325-013600
CK10436-10-C	80-20325-017509	CK224	80-20325-016816	CK3124-10-2	80-20325-017547	CK619-C	80-20325-016618
CK10457	80-20325-017141	CK2243	80-20325-015345	CK3124-10-C-2	80-20325-017554	CK77366480	80-20325-019688
CK10457-C	80-20325-017158	CK2243-C	80-20325-016571	CK3139-2	80-20325-015154	CK77366480-C	80-20325-021698
CK10474-2	80-20325-018346	CK23003	80-20325-020394	CK3139-C-2	80-20325-015161	CK8103	80-20325-013617
CK10474-C-2	80-20325-018353	CK23005-C-2	80-20325-021414	CK321	80-20325-015925	CK8430	80-20325-017226
CK10529	80-20325-018728	CK23010-C	80-20325-020967	CK3435	80-20325-015932	CK8430-C	80-20325-015062
CK10529-C	80-20325-018735	CK23011	80-20325-020424	CK3435-C	80-20325-016175	CK8714	80-20325-013624
CK10534-2	80-20325-018520	CK2330	80-20325-021087	CK3540	80-20325-016236	CK8714-C	80-20325-013631
CK10534-C-2	80-20325-018377	CK2331	80-20325-020608	CK3540-C	80-20325-016243	CK8717	80-20325-018858
CK10536-10-2	80-20325-017523	CK2331-C	80-20325-020837	CK384-C	80-20325-013136	CK8717-C	80-20325-018865
CK10536-10-C-2	80-20325-017530	CK2336	80-20325-020646	CK421-2	80-20325-013143	CK8719	80-20325-015178
CK10657-10-C	80-20325-017806	CK2356	80-20325-016229	CK421-C-2	80-20325-015550	CK8750	80-20325-013648
CK10774	80-20325-018384	CK24003	80-20325-020264	CK4436	80-20325-017196	CK8777	80-20325-013655
CK10774-C	80-20325-018391	CK24003-C	80-20325-020127	CK4436-C	80-20325-017202	CK8777-C	80-20325-013662
CK11177	80-20325-019312	CK24004	80-20325-020622	CK5366	80-20325-016250	CK8778-C	80-20325-015574
CK11177-C	80-20325-019329	CK24004-C	80-20325-020844	CK5366-C	80-20325-016267	CK879	80-20325-019404
CK11743	80-20325-021476	CK24009	80-20325-021155	CK5474	80-20325-013150	CK8799	80-20325-013679
CK1611-C	80-20325-016526	CK24013	80-20325-022008	CK5475	80-20325-013167	CK879-C	80-20325-019411
CK1629	80-20325-018797	CK2434	80-20325-021018	CK5475-C	80-20325-013174	CK8831	80-20325-013686
CK1629-C	80-20325-018803	CK2434-C	80-20325-020998	CK5551	80-20325-013181	CK8831-C	80-20325-013693
CK17001	80-20325-021179	CK2436-10	80-20325-017653	CK5562	80-20325-013198	CK8832-2	80-20325-013709
CK1719	80-20325-021162	CK25001-C	80-20325-020134	CK5562-C	80-20325-013204	CK8838	80-20325-013716
CK1721-2	80-20325-022107	CK25002	80-20325-021148	CK5563	80-20325-013228	CK8838-C	80-20325-013723
CK1811-2	80-20325-021971	CK25002-C	80-20325-021186	CK5563-C	80-20325-013211	CK8867	80-20325-013730
CK1811-C-2	80-20325-021988	CK25003	80-20325-021520	CK5564	80-20325-013235	CK8867-C	80-20325-013747
CK1827	80-20325-015307	CK25007	80-20325-019343	CK5564-C	80-20325-013242	CK8868	80-20325-013754
CK1830-C	80-20325-015314	CK25008-2	80-20325-021100	CK5565	80-20325-013259	CK8868-C	80-20325-013761
CK19001	80-20325-020691	CK25008-C-2	80-20325-021209	CK5565-C	80-20325-013266	CK8869-C	80-20325-013778
CK19004-2	80-20325-020080	CK25012	80-20325-020660	CK5816	80-20325-013273	CK8890	80-20325-013785
CK19004-C-2	80-20325-020615	CK25012-C	80-20325-020974	CK5816-C	80-20325-013280	CK8912-2	80-20325-013792
CK1910	80-20325-015895	CK2504	80-20325-015918	CK5817	80-20325-013297	CK8912-C-2	80-20325-013808
CK1910-C	80-20325-015901	CK2506-2	80-20325-017394	CK5817-C	80-20325-013303	CK8913	80-20325-013815
CK1919	80-20325-016533	CK2532-10	80-20325-017516	CK5818	80-20325-013310	CK8913-C	80-20325-013822
CK1919-C	80-20325-016540	CK2533-2	80-20325-020684	CK5818-C	80-20325-017219	CK8914-2	80-20325-013839
CK1930-2	80-20325-017165	CK2542-2	80-20325-017080	CK5819	80-20325-013327	CK8947-3	80-20325-013846
CK1936	80-20325-017172	CK2544	80-20325-016595	CK5819-C	80-20325-013334	CK8989	80-20325-013853
CK1936-C	80-20325-017400	CK26006	80-20325-019749	CK5823	80-20325-013358	CK9051	80-20325-013860
CK200	80-20325-015321	CK26008-2	80-20325-020400	CK5823-C	80-20325-013365	CK9051-C	80-20325-013877
CK20006	80-20325-019336	CK26009	80-20325-019367	CK5824	80-20325-013372	CK9071	80-20325-013884
CK20006-C	80-20325-021025	CK26009-C	80-20325-019374	CK5824-C	80-20325-015567	CK9071-C	80-20325-017097
CK20010	80-20325-020479	CK26010	80-20325-019381	CK5841	80-20325-013389	CK9077	80-20325-013891
CK20010-C	80-20325-020486	CK26010-C	80-20325-019398	CK5842	80-20325-013396	CK9077-C	80-20325-013907

THE INDEPENDENT FILTERS FACTORY

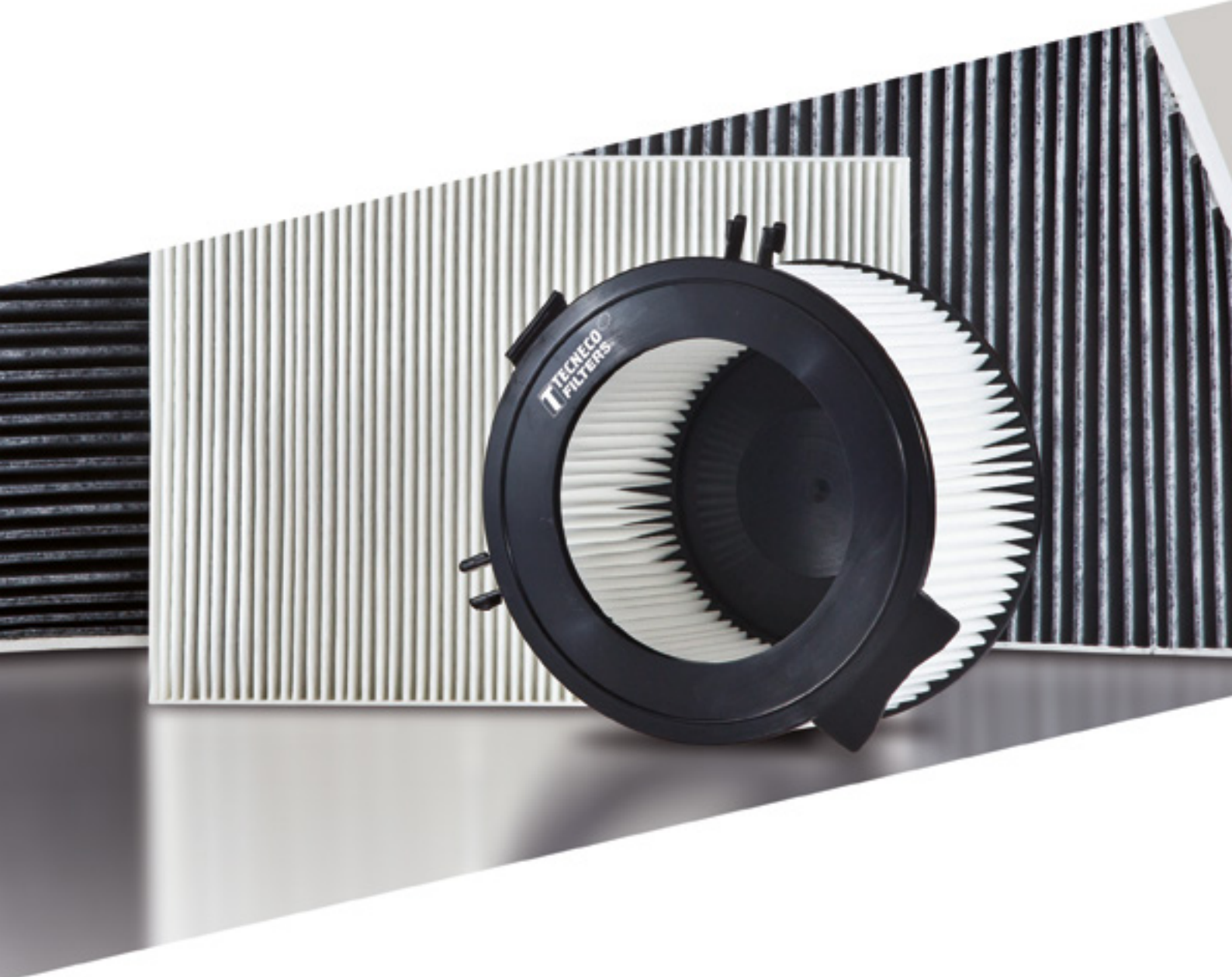

Ultra-thin III
Filtration Technology





Smart solutions in filtration



TECNECO FILTRI srl
Sede Commerciale, Logistica, Produttiva Filtri Aria
Sales Office, Logistic, Air Filters Manufacturing

Strada Provinciale 361, Km11
73040 Collepasso (Lecce) - Italia
Tel. +39 (0)833 345304 / 346807
Fax +39 (0)833 346696
tecneco@tecneco.com

TECNECO FILTRI srl
Sede Produttiva Filtri Olio e Filtri Carburante
Oil Filters and Fuel Filters Manufacturing

Zona Industriale - Lotto Nr.32
73040 Collepasso (Lecce) - Italia
Tel. +39 (0)833 342032
Fax +39 (0)833 342116
tecnecoinvesti@tecneco.com

www.tecneco.com



www.tecneco.com
ONLINE
CATALOGUE

ALWAYS UP TO DATE